



G2000 series Online Manual

Printer Functions
 Overview
 Printing
 Scanning
 Troubleshooting

Contents

Using This Online Manual.	11
Trademarks and Licenses.	12
Search Tips.	20
Using the Machine.	22
Printing Photos from a Computer.	23
Copying Originals.	26
Printer Functions.	28
Print Photos Easily Using My Image Garden.	29
Easy Scan with the Auto Function.	31
Scan Originals Larger than the Platen.	32
Scan Multiple Originals at One Time.	33
Online Storage Integration Function.	34
Handling Paper, Originals, Ink Tanks, etc..	35
Loading Paper.	36
Loading Plain Paper / Photo Paper.	37
Loading Envelopes.	40
Loading Originals.	43
Loading Originals on the Platen Glass.	44
Originals You Can Load.	46
Refilling Ink Tanks.	47
Refilling Ink Tanks.	48
Checking Ink Status.	55
Maintenance.	57
If Printing Is Faint or Uneven.	58
Maintenance Procedure.	59
Printing the Nozzle Check Pattern.	61
Examining the Nozzle Check Pattern.	62
Cleaning the Print Head.	63
Cleaning the Print Head Deeply.	64
Aligning the Print Head.	65

Performing Maintenance Functions from Your Computer (Mac OS)	67
Cleaning the Print Heads	68
Cleaning Inside the Printer	71
Cleaning the Paper Feed Rollers	72
Printing a Nozzle Check Pattern	73
Aligning the Print Head	74
Aligning the Print Head Position	75
Aligning the Print Head Position Automatically	78
Cleaning	79
Cleaning the Exterior of the Machine	80
Cleaning the Platen Glass and Document Cover	81
Cleaning the Paper Feed Roller	82
Cleaning the Inside of the Machine (Bottom Plate Cleaning)	83
Overview	85
Safety	86
Safety Precautions	87
Regulatory Information	88
Main Components and Their Use	100
Main Components	101
Front View	102
Rear View	104
Inside View	105
Operation Panel	106
Power Supply	108
Confirming that the Power Is On	109
Turning the Machine On and Off	110
Notice for the Power Plug/Power Cord	112
Notice for Unplugging the Power Cord	113
Changing Settings	114
Changing Printer Settings from Your Computer (Mac OS)	115
Registering a Changed Printing Profile	116
Changing the remaining ink level notification setting	118
Managing the Printer Power	120
Reducing the Printer Noise	122

Changing the Printer Operation Mode.	124
Changing Settings from Operation Panel.	125
Quiet setting.	126
Turning on/off Machine Automatically.	127
Initializing Machine Settings.	128
Ensuring Optimal Printing Results.	129
Ink Tips.	130
Printing Tips.	131
Be Sure to Make Paper Settings after Loading Paper.	132
Canceling a Print Job.	133
Machine Handling Precautions.	134
Keeping Print Quality High.	135
Transporting Your Printer.	136
Legal Restrictions on Scanning/Copying.	138
Specifications.	139
Information about Paper.	142
Media Types You Can Use.	143
Paper Load Limit.	145
Media Types You Cannot Use.	147
Printing Area.	148
Printing Area.	149
Other Sizes than Letter, Legal, Envelopes.	150
Letter, Legal.	151
Envelopes.	152
Administrator Password.	153
Authentication.	154
Where Serial Number Is Located.	155
List of Function for Each Model.	156
Printing.	158
Printing from Computer.	159
Printing from Application Software (Mac OS Printer Driver).	160
Printing with Easy Setup.	161

Paper Settings on the Printer Driver.	165
Various Printing Methods.	166
Setting the Number of Copies and Printing Order.	167
Setting the Stapling Margin.	169
Execute Borderless Printing.	170
Scaling the Printing to Fit the Paper Size.	173
Scaled Printing.	175
Page Layout Printing.	176
Setting Up Envelope Printing.	178
Setting Paper Dimensions (Custom Size).	179
Changing the Print Quality and Correcting Image Data.	180
Setting the Print Quality Level (Custom).	181
Printing a Color Document in Monochrome.	182
Specifying Color Correction.	183
Optimal Photo Printing of Image Data.	185
Adjusting Colors with the Printer Driver.	186
Printing with ICC Profiles (Specifying an ICC Profile from the Application Software).	187
Printing with ICC Profiles (Specifying an ICC Profile from the Printer Driver).	189
Adjusting Color Balance.	190
Adjusting Brightness.	192
Adjusting Intensity.	194
Adjusting Contrast.	196
Overview of the Printer Driver.	198
Canon IJ Printer Driver.	199
How to Open the Printer Driver Setup Window.	200
Page Setup Dialog.	201
Print Dialog.	202
Quality & Media.	204
Color Options.	206
Borderless Printing.	208
Margin.	209
Canon IJ Printer Utility.	210
Opening the Canon IJ Printer Utility.	212
Maintenance of this Printer.	213
Display the Printing Status Screen.	214
Deleting the Undesired Print Job.	216
Instructions for Use (Printer Driver).	217

Updating the Printer Driver.	218
Obtaining the Latest Printer Driver.	219
Delete the Unnecessary Canon IJ Printer from the Printer List.	220
Before Installing the Printer Driver.	221
Installing the Printer Driver.	222
Sharing the Printer on a Network.	223
Settings on Print Server.	224
Settings on Client PC.	225
Restrictions on Printer Sharing.	226
Printing Using Canon Application Software.	227
My Image Garden Guide.	228
Copying.	229
Making Copies on Plain Paper.	230
Switching Page Size between A4 and Letter.	231
Scanning.	232
Scanning from Computer (Windows).	233
Scanning from Computer (Mac OS).	234
Using IJ Scan Utility.	235
What Is IJ Scan Utility (Scanner Software)?.	236
Starting IJ Scan Utility.	238
Easy Scanning with Auto Scan.	239
Scanning Documents.	240
Scanning Photos.	241
Scanning with Favorite Settings.	242
Scanning Originals Larger than the Platen (Image Stitch).	243
Adjusting Cropping Frames in the Image Stitch Window.	248
Scanning Multiple Originals at One Time.	249
Saving after Checking Scan Results.	252
Sending Scanned Images via E-mail.	255
Extracting Text from Scanned Images (OCR).	258
IJ Scan Utility Screens.	262
IJ Scan Utility Main Screen.	263
Settings Dialog.	265
Save Settings Dialog.	296

Image Stitch Window.	299
Using Scanner Driver.	304
Image Corrections and Color Adjustments.	305
General Notes (Scanner Driver).	309
Updating the Scanner Driver.	310
Obtaining the Latest Scanner Driver.	311
Before Installing the Scanner Driver.	312
Installing the Scanner Driver.	313
Scanning Tips.	314
Resolution.	315
Data Formats.	317
Positioning Originals (Scanning from Computer).	318
Troubleshooting.	320
Printing Problems.	322
Printing Does Not Start.	323
Paper Jams.	325
Print Results Are Unsatisfactory.	326
Cannot Complete Printing.	328
Paper Is Blank/Printing Is Blurry/Colors Are Wrong/White Streaks Appear.	329
Colors Are Unclear.	333
Lines Are Misaligned.	335
Lines Incomplete or Missing (Windows).	336
Images Incomplete or Missing (Windows).	337
Ink Blots / Paper Curl.	338
Paper Is Smudged / Printed Surface Is Scratched.	339
Back of Paper Is Smudged.	343
Vertical Line Next to Image.	344
Uneven or Streaked Colors.	345
No Ink Comes Out.	347
Paper Does Not Feed Properly/"No Paper" Error.	349
Copying/Printing Stops.	351
Scanning Problems (Mac OS).	352
Scanning Problems.	353
Scanner Does Not Work.	354

Scanner Driver Does Not Start.	355
Error Message Appears and the Scanner Driver Screen Does Not Appear.	356
Cannot Scan Multiple Originals at One Time.	357
Cannot Scan Properly with Auto Scan.	358
Slow Scanning Speed.	359
"There is not enough memory." Message Is Displayed.	360
Computer Stops Operating during Scanning.	361
Scanned Image Does Not Open.	362
Scan Results Are Unsatisfactory.	363
Scan Quality (Image Displayed on the Monitor) Is Poor.	364
Scanned Image Is Surrounded by Extra White Areas.	365
Cannot Scan at the Correct Size.	366
Original Is Placed Correctly, but the Scanned Image Is Slanted.	367
Scanned Image Is Enlarged (Reduced) on the Computer Monitor.	368
IJ Scan Utility Error Messages.	369
Scanner Driver Error Messages.	371
Mechanical Problems.	372
Power Does Not Come On.	373
Power Shuts Off By Itself.	374
Cannot Connect to Computer Properly.	375
Printer Status Monitor Not Displayed (Windows).	376
Installation and Download Problems.	377
Cannot Install MP Drivers.	378
Easy-WebPrint EX Does Not Start or Easy-WebPrint EX Menu Does Not Appear (Windows).	380
Errors and Messages.	381
An Error Occurs.	382
Message Appears.	385
"The printer is performing another operation" Appears on Computer Screen.	392
If You Cannot Solve a Problem.	393
Repairing Your Machine.	394
List of Support Code for Error.	396
List of Support Code for Error (Paper Jams).	397
1300.	398
Paper Is Jammed inside Machine.	399

Other Cases.....	403
1000.....	404
1200.....	405
1403.....	406
1470.....	407
1471.....	408
1472.....	409
1473.....	410
1474.....	411
1475.....	412
1476.....	413
1640.....	414
1700.....	415
1701.....	416
1890.....	417
2900.....	418
2901.....	419
5011.....	420
5012.....	421
5050.....	422
5100.....	423
5200.....	424
5400.....	425
5700.....	426
5B00.....	427
5B01.....	428
6000.....	429
6800.....	430
6801.....	431
6930.....	432
6931.....	433
6932.....	434

6933.....	435
6936.....	436
6937.....	437
6938.....	438
6940.....	439
6941.....	440
6942.....	441
6943.....	442
6944.....	443
6945.....	444
6946.....	445
B202.....	446
B203.....	447
B204.....	448
B205.....	449

Using This Online Manual

- [Symbols Used in This Document](#)
- [Touch-enabled Device Users \(Windows\)](#)

Symbols Used in This Document

Warning

Instructions that, if ignored, could result in death or serious personal injury caused by incorrect operation of the equipment. These must be observed for safe operation.

Caution

Instructions that, if ignored, could result in personal injury or material damage caused by incorrect operation of the equipment. These must be observed for safe operation.

Important

Instructions including important information. To avoid damage and injury or improper use of the product, be sure to read these indications.

Note

Instructions including notes for operation and additional explanations.

Basics

Instructions explaining basic operations of your product.

Note

-
- Icons may vary depending on your product.
-

Touch-enabled Device Users (Windows)

For touch actions, you need to replace "right-click" in this document with the action set on the operating system. For example, if the action is set to "press and hold" on your operating system, replace "right-click" with "press and hold."

Trademarks and Licenses

- Microsoft is a registered trademark of Microsoft Corporation.
- Windows is a trademark or registered trademark of Microsoft Corporation in the U.S. and/or other countries.
- Windows Vista is a trademark or registered trademark of Microsoft Corporation in the U.S. and/or other countries.
- Internet Explorer is a trademark or registered trademark of Microsoft Corporation in the U.S. and/or other countries.
- Mac, Mac OS, AirPort, Safari, Bonjour, iPad, iPhone and iPod touch are trademarks of Apple Inc., registered in the U.S. and other countries. App Store, AirPrint and the AirPrint logo are trademarks of Apple Inc.
- IOS is a trademark or registered trademark of Cisco in the U.S. and other countries and is used under license.
- Google Cloud Print, Google Chrome, Chrome OS, Chromebook, Android, Google Play and Picasa are either registered trademarks or trademarks of Google Inc.
- Adobe, Flash, Photoshop, Photoshop Elements, Lightroom, Adobe RGB and Adobe RGB (1998) are either registered trademarks or trademarks of Adobe Systems Incorporated in the United States and/or other countries.
- Bluetooth is a trademark of Bluetooth SIG, Inc., U.S.A. and licensed to Canon Inc.

►► Note

- The formal name of Windows Vista is Microsoft Windows Vista operating system.

Copyright (c) 2003-2004, Apple Computer, Inc. All rights reserved.

Redistribution and use in source and binary forms, with or without modification, are permitted provided that the following conditions are met:

1. Redistributions of source code must retain the above copyright notice, this list of conditions and the following disclaimer.
2. Redistributions in binary form must reproduce the above copyright notice, this list of conditions and the following disclaimer in the documentation and/or other materials provided with the distribution.
3. Neither the name of Apple Computer, Inc. ("Apple") nor the names of its contributors may be used to endorse or promote products derived from this software without specific prior written permission.

THIS SOFTWARE IS PROVIDED BY APPLE AND ITS CONTRIBUTORS "AS IS" AND ANY EXPRESS OR IMPLIED WARRANTIES, INCLUDING, BUT NOT LIMITED TO, THE IMPLIED WARRANTIES OF MERCHANTABILITY AND FITNESS FOR A PARTICULAR PURPOSE ARE DISCLAIMED. IN NO EVENT SHALL APPLE OR ITS CONTRIBUTORS BE LIABLE FOR ANY DIRECT, INDIRECT, INCIDENTAL, SPECIAL, EXEMPLARY, OR CONSEQUENTIAL DAMAGES (INCLUDING, BUT NOT LIMITED TO, PROCUREMENT OF SUBSTITUTE GOODS OR SERVICES; LOSS OF USE, DATA, OR PROFITS; OR BUSINESS INTERRUPTION) HOWEVER CAUSED AND ON ANY THEORY OF LIABILITY, WHETHER IN CONTRACT, STRICT LIABILITY, OR TORT INCLUDING NEGLIGENCE OR OTHERWISE) ARISING IN ANY WAY OUT OF THE USE OF THIS SOFTWARE, EVEN IF ADVISED OF THE POSSIBILITY OF SUCH DAMAGE.

Apache License

TERMS AND CONDITIONS FOR USE, REPRODUCTION, AND DISTRIBUTION

1. Definitions.

"License" shall mean the terms and conditions for use, reproduction, and distribution as defined by Sections 1 through 9 of this document.

"Licensor" shall mean the copyright owner or entity authorized by the copyright owner that is granting the License.

"Legal Entity" shall mean the union of the acting entity and all other entities that control, are controlled by, or are under common control with that entity. For the purposes of this definition, "control" means (i) the power, direct or indirect, to cause the direction or management of such entity, whether by contract or otherwise, or (ii) ownership of fifty percent (50%) or more of the outstanding shares, or (iii) beneficial ownership of such entity.

"You" (or "Your") shall mean an individual or Legal Entity exercising permissions granted by this License.

"Source" form shall mean the preferred form for making modifications, including but not limited to software source code, documentation source, and configuration files.

"Object" form shall mean any form resulting from mechanical transformation or translation of a Source form, including but not limited to compiled object code, generated documentation, and conversions to other media types.

"Work" shall mean the work of authorship, whether in Source or Object form, made available under the License, as indicated by a copyright notice that is included in or attached to the work (an example is provided in the Appendix below).

"Derivative Works" shall mean any work, whether in Source or Object form, that is based on (or derived from) the Work and for which the editorial revisions, annotations, elaborations, or other modifications represent, as a whole, an original work of authorship. For the purposes of this License, Derivative Works shall not include works that remain separable from, or merely link (or bind by name) to the interfaces of, the Work and Derivative Works thereof.

"Contribution" shall mean any work of authorship, including the original version of the Work and any modifications or additions to that Work or Derivative Works thereof, that is intentionally submitted to Licensor for inclusion in the Work by the copyright owner or by an individual or Legal Entity authorized to submit on behalf of the copyright owner. For the purposes of this definition, "submitted" means any form of electronic, verbal, or written communication sent to the Licensor or its representatives, including but not limited to communication on electronic mailing lists, source code control systems, and issue tracking systems that are managed by, or on behalf of, the Licensor for the purpose of discussing and improving the Work, but excluding communication that is conspicuously marked or otherwise designated in writing by the copyright owner as "Not a Contribution."

"Contributor" shall mean Licensor and any individual or Legal Entity on behalf of whom a Contribution has been received by Licensor and subsequently incorporated within the Work.

2. Grant of Copyright License. Subject to the terms and conditions of this License, each Contributor hereby grants to You a perpetual, worldwide, non-exclusive, no-charge, royalty-free, irrevocable copyright license to reproduce, prepare Derivative Works of, publicly display, publicly perform, sublicense, and distribute the Work and such Derivative Works in Source or Object form.

3. Grant of Patent License. Subject to the terms and conditions of this License, each Contributor hereby grants to You a perpetual, worldwide, non-exclusive, no-charge, royalty-free, irrevocable (except as stated in this section) patent license to make, have made, use, offer to sell, sell, import, and otherwise transfer the Work, where such license applies only to those patent claims licensable by such Contributor that are necessarily infringed by their Contribution(s) alone or by combination of their Contribution(s) with the Work to which such Contribution(s) was submitted. If You institute patent litigation against any entity (including a cross-claim or counterclaim in a lawsuit) alleging that the Work or a Contribution incorporated within the Work constitutes direct or contributory patent infringement, then any patent licenses granted to You under this License for that Work shall terminate as of the date such litigation is filed.

4. Redistribution. You may reproduce and distribute copies of the Work or Derivative Works thereof in any medium, with or without modifications, and in Source or Object form, provided that You meet the following conditions:

1. You must give any other recipients of the Work or Derivative Works a copy of this License; and
2. You must cause any modified files to carry prominent notices stating that You changed the files; and
3. You must retain, in the Source form of any Derivative Works that You distribute, all copyright, patent, trademark, and attribution notices from the Source form of the Work, excluding those notices that do not pertain to any part of the Derivative Works; and
4. If the Work includes a "NOTICE" text file as part of its distribution, then any Derivative Works that You distribute must include a readable copy of the attribution notices contained within such NOTICE file, excluding those notices that do not pertain to any part of the Derivative Works, in at least one of the following places: within a NOTICE text file distributed as part of the Derivative Works; within the Source form or documentation, if provided along with the Derivative Works; or, within a display generated by the Derivative Works, if and wherever such third-party notices normally appear. The contents of the NOTICE file are for informational purposes only and do not modify the License. You may add Your own attribution notices within Derivative Works that You distribute, alongside or as an addendum to the NOTICE text from the Work, provided that such additional attribution notices cannot be construed as modifying the License.

You may add Your own copyright statement to Your modifications and may provide additional or different license terms and conditions for use, reproduction, or distribution of Your modifications, or for any such Derivative Works as a whole, provided Your use, reproduction, and distribution of the Work otherwise complies with the conditions stated in this License.

5. Submission of Contributions. Unless You explicitly state otherwise, any Contribution intentionally submitted for inclusion in the Work by You to the Licensor shall be under the terms and conditions of this License, without any additional terms or conditions. Notwithstanding the above, nothing herein shall supersede or modify the terms of any separate license agreement you may have executed with Licensor regarding such Contributions.

6. Trademarks. This License does not grant permission to use the trade names, trademarks, service marks, or product names of the Licensor, except as required for reasonable and customary use in describing the origin of the Work and reproducing the content of the NOTICE file.

7. Disclaimer of Warranty. Unless required by applicable law or agreed to in writing, Licensor provides the Work (and each Contributor provides its Contributions) on an "AS IS" BASIS, WITHOUT WARRANTIES OR CONDITIONS OF ANY KIND, either express or implied, including, without limitation, any warranties or conditions of TITLE, NON-INFRINGEMENT, MERCHANTABILITY, or FITNESS FOR A PARTICULAR PURPOSE. You are solely responsible for determining the

appropriateness of using or redistributing the Work and assume any risks associated with Your exercise of permissions under this License.

8. Limitation of Liability. In no event and under no legal theory, whether in tort (including negligence), contract, or otherwise, unless required by applicable law (such as deliberate and grossly negligent acts) or agreed to in writing, shall any Contributor be liable to You for damages, including any direct, indirect, special, incidental, or consequential damages of any character arising as a result of this License or out of the use or inability to use the Work (including but not limited to damages for loss of goodwill, work stoppage, computer failure or malfunction, or any and all other commercial damages or losses), even if such Contributor has been advised of the possibility of such damages.
9. Accepting Warranty or Additional Liability. While redistributing the Work or Derivative Works thereof, You may choose to offer, and charge a fee for, acceptance of support, warranty, indemnity, or other liability obligations and/or rights consistent with this License. However, in accepting such obligations, You may act only on Your own behalf and on Your sole responsibility, not on behalf of any other Contributor, and only if You agree to indemnify, defend, and hold each Contributor harmless for any liability incurred by, or claims asserted against, such Contributor by reason of your accepting any such warranty or additional liability.

END OF TERMS AND CONDITIONS

---- Part 1: CMU/UCD copyright notice: (BSD like) ----

Copyright 1989, 1991, 1992 by Carnegie Mellon University

Derivative Work - 1996, 1998-2000

Copyright 1996, 1998-2000 The Regents of the University of California

All Rights Reserved

Permission to use, copy, modify and distribute this software and its documentation for any purpose and without fee is hereby granted, provided that the above copyright notice appears in all copies and that both that copyright notice and this permission notice appear in supporting documentation, and that the name of CMU and The Regents of the University of California not be used in advertising or publicity pertaining to distribution of the software without specific written permission.

CMU AND THE REGENTS OF THE UNIVERSITY OF CALIFORNIA DISCLAIM ALL WARRANTIES WITH REGARD TO THIS SOFTWARE, INCLUDING ALL IMPLIED WARRANTIES OF MERCHANTABILITY AND FITNESS. IN NO EVENT SHALL CMU OR THE REGENTS OF THE UNIVERSITY OF CALIFORNIA BE LIABLE FOR ANY SPECIAL, INDIRECT OR CONSEQUENTIAL DAMAGES OR ANY DAMAGES WHATSOEVER RESULTING FROM THE LOSS OF USE, DATA OR PROFITS, WHETHER IN AN ACTION OF CONTRACT, NEGLIGENCE OR OTHER TORTIOUS ACTION, ARISING OUT OF OR IN CONNECTION WITH THE USE OR PERFORMANCE OF THIS SOFTWARE.

---- Part 2: Networks Associates Technology, Inc copyright notice (BSD) ----

Copyright (c) 2001-2003, Networks Associates Technology, Inc

All rights reserved.

Redistribution and use in source and binary forms, with or without modification, are permitted provided that the following conditions are met:

* Redistributions of source code must retain the above copyright notice, this list of conditions and the following disclaimer.

* Redistributions in binary form must reproduce the above copyright notice, this list of conditions and the following disclaimer in the documentation and/or other materials provided with the distribution.

* Neither the name of the Networks Associates Technology, Inc nor the names of its contributors may be used to endorse or promote products derived from this software without specific prior written permission.

THIS SOFTWARE IS PROVIDED BY THE COPYRIGHT HOLDERS AND CONTRIBUTORS ``AS IS" AND ANY EXPRESS OR IMPLIED WARRANTIES, INCLUDING, BUT NOT LIMITED TO, THE IMPLIED WARRANTIES OF MERCHANTABILITY AND FITNESS FOR A PARTICULAR PURPOSE ARE DISCLAIMED. IN NO EVENT SHALL THE COPYRIGHT HOLDERS OR CONTRIBUTORS BE LIABLE FOR ANY DIRECT, INDIRECT, INCIDENTAL, SPECIAL, EXEMPLARY, OR CONSEQUENTIAL DAMAGES (INCLUDING, BUT NOT LIMITED TO, PROCUREMENT OF SUBSTITUTE GOODS OR SERVICES; LOSS OF USE, DATA, OR PROFITS; OR BUSINESS INTERRUPTION) HOWEVER CAUSED AND ON ANY THEORY OF LIABILITY, WHETHER IN CONTRACT, STRICT LIABILITY, OR TORT (INCLUDING NEGLIGENCE OR OTHERWISE) ARISING IN ANY WAY OUT OF THE USE OF THIS SOFTWARE, EVEN IF ADVISED OF THE POSSIBILITY OF SUCH DAMAGE.

---- Part 3: Cambridge Broadband Ltd. copyright notice (BSD) ----

Portions of this code are copyright (c) 2001-2003, Cambridge Broadband Ltd.

All rights reserved.

Redistribution and use in source and binary forms, with or without modification, are permitted provided that the following conditions are met:

* Redistributions of source code must retain the above copyright notice, this list of conditions and the following disclaimer.

* Redistributions in binary form must reproduce the above copyright notice, this list of conditions and the following disclaimer in the documentation and/or other materials provided with the distribution.

* The name of Cambridge Broadband Ltd. may not be used to endorse or promote products derived from this software without specific prior written permission.

THIS SOFTWARE IS PROVIDED BY THE COPYRIGHT HOLDER ``AS IS" AND ANY EXPRESS OR IMPLIED WARRANTIES, INCLUDING, BUT NOT LIMITED TO, THE IMPLIED WARRANTIES OF MERCHANTABILITY AND FITNESS FOR A PARTICULAR PURPOSE ARE DISCLAIMED. IN NO EVENT SHALL THE COPYRIGHT HOLDER BE LIABLE FOR ANY DIRECT, INDIRECT, INCIDENTAL, SPECIAL, EXEMPLARY, OR CONSEQUENTIAL DAMAGES (INCLUDING, BUT NOT LIMITED TO, PROCUREMENT OF SUBSTITUTE GOODS OR SERVICES; LOSS OF USE, DATA, OR PROFITS; OR BUSINESS INTERRUPTION) HOWEVER CAUSED AND ON ANY THEORY OF LIABILITY, WHETHER IN CONTRACT, STRICT LIABILITY, OR TORT (INCLUDING NEGLIGENCE OR OTHERWISE) ARISING IN ANY WAY OUT OF THE USE OF THIS SOFTWARE, EVEN IF ADVISED OF THE POSSIBILITY OF SUCH DAMAGE.

---- Part 4: Sun Microsystems, Inc. copyright notice (BSD) ----

Copyright c 2003 Sun Microsystems, Inc., 4150 Network Circle, Santa Clara, California 95054, U.S.A. All rights reserved.

Use is subject to license terms below.

This distribution may include materials developed by third parties.

Sun, Sun Microsystems, the Sun logo and Solaris are trademarks or registered trademarks of Sun Microsystems, Inc. in the U.S. and other countries.

Redistribution and use in source and binary forms, with or without modification, are permitted provided that the following conditions are met:

- * Redistributions of source code must retain the above copyright notice, this list of conditions and the following disclaimer.
- * Redistributions in binary form must reproduce the above copyright notice, this list of conditions and the following disclaimer in the documentation and/or other materials provided with the distribution.
- * Neither the name of the Sun Microsystems, Inc. nor the names of its contributors may be used to endorse or promote products derived from this software without specific prior written permission.

THIS SOFTWARE IS PROVIDED BY THE COPYRIGHT HOLDERS AND CONTRIBUTORS ``AS IS'' AND ANY EXPRESS OR IMPLIED WARRANTIES, INCLUDING, BUT NOT LIMITED TO, THE IMPLIED WARRANTIES OF MERCHANTABILITY AND FITNESS FOR A PARTICULAR PURPOSE ARE DISCLAIMED. IN NO EVENT SHALL THE COPYRIGHT HOLDERS OR CONTRIBUTORS BE LIABLE FOR ANY DIRECT, INDIRECT, INCIDENTAL, SPECIAL, EXEMPLARY, OR CONSEQUENTIAL DAMAGES (INCLUDING, BUT NOT LIMITED TO, PROCUREMENT OF SUBSTITUTE GOODS OR SERVICES; LOSS OF USE, DATA, OR PROFITS; OR BUSINESS INTERRUPTION) HOWEVER CAUSED AND ON ANY THEORY OF LIABILITY, WHETHER IN CONTRACT, STRICT LIABILITY, OR TORT (INCLUDING NEGLIGENCE OR OTHERWISE) ARISING IN ANY WAY OUT OF THE USE OF THIS SOFTWARE, EVEN IF ADVISED OF THE POSSIBILITY OF SUCH DAMAGE.

---- Part 5: Sparta, Inc copyright notice (BSD) ----

Copyright (c) 2003-2009, Sparta, Inc

All rights reserved.

Redistribution and use in source and binary forms, with or without modification, are permitted provided that the following conditions are met:

- * Redistributions of source code must retain the above copyright notice, this list of conditions and the following disclaimer.
- * Redistributions in binary form must reproduce the above copyright notice, this list of conditions and the following disclaimer in the documentation and/or other materials provided with the distribution.
- * Neither the name of Sparta, Inc nor the names of its contributors may be used to endorse or promote products derived from this software without specific prior written permission.

THIS SOFTWARE IS PROVIDED BY THE COPYRIGHT HOLDERS AND CONTRIBUTORS ``AS IS'' AND ANY EXPRESS OR IMPLIED WARRANTIES, INCLUDING, BUT NOT LIMITED TO, THE IMPLIED WARRANTIES OF MERCHANTABILITY AND FITNESS FOR A PARTICULAR PURPOSE ARE DISCLAIMED. IN NO EVENT SHALL THE COPYRIGHT HOLDERS OR CONTRIBUTORS BE LIABLE FOR ANY DIRECT, INDIRECT, INCIDENTAL, SPECIAL, EXEMPLARY, OR CONSEQUENTIAL DAMAGES (INCLUDING, BUT NOT LIMITED TO, PROCUREMENT OF SUBSTITUTE GOODS OR SERVICES; LOSS OF USE, DATA, OR PROFITS; OR BUSINESS INTERRUPTION) HOWEVER CAUSED AND ON ANY THEORY OF LIABILITY, WHETHER IN CONTRACT, STRICT LIABILITY, OR TORT (INCLUDING NEGLIGENCE OR OTHERWISE) ARISING IN ANY WAY OUT OF THE USE OF THIS SOFTWARE, EVEN IF ADVISED OF THE POSSIBILITY OF SUCH DAMAGE.

---- Part 6: Cisco/BUPTNIC copyright notice (BSD) ----

Copyright (c) 2004, Cisco, Inc and Information Network Center of Beijing University of Posts and Telecommunications.

All rights reserved.

Redistribution and use in source and binary forms, with or without modification, are permitted provided that the following conditions are met:

- * Redistributions of source code must retain the above copyright notice, this list of conditions and the following disclaimer.
- * Redistributions in binary form must reproduce the above copyright notice, this list of conditions and the following disclaimer in the documentation and/or other materials provided with the distribution.
- * Neither the name of Cisco, Inc, Beijing University of Posts and Telecommunications, nor the names of their contributors may be used to endorse or promote products derived from this software without specific prior written permission.

THIS SOFTWARE IS PROVIDED BY THE COPYRIGHT HOLDERS AND CONTRIBUTORS ``AS IS" AND ANY EXPRESS OR IMPLIED WARRANTIES, INCLUDING, BUT NOT LIMITED TO, THE IMPLIED WARRANTIES OF MERCHANTABILITY AND FITNESS FOR A PARTICULAR PURPOSE ARE DISCLAIMED. IN NO EVENT SHALL THE COPYRIGHT HOLDERS OR CONTRIBUTORS BE LIABLE FOR ANY DIRECT, INDIRECT, INCIDENTAL, SPECIAL, EXEMPLARY, OR CONSEQUENTIAL DAMAGES (INCLUDING, BUT NOT LIMITED TO, PROCUREMENT OF SUBSTITUTE GOODS OR SERVICES; LOSS OF USE, DATA, OR PROFITS; OR BUSINESS INTERRUPTION) HOWEVER CAUSED AND ON ANY THEORY OF LIABILITY, WHETHER IN CONTRACT, STRICT LIABILITY, OR TORT (INCLUDING NEGLIGENCE OR OTHERWISE) ARISING IN ANY WAY OUT OF THE USE OF THIS SOFTWARE, EVEN IF ADVISED OF THE POSSIBILITY OF SUCH DAMAGE.

---- Part 7: Fabasoft R&D Software GmbH & Co KG copyright notice (BSD) -----

Copyright (c) Fabasoft R&D Software GmbH & Co KG, 2003 oss@fabasoft.com

Author: Bernhard Penz

Redistribution and use in source and binary forms, with or without modification, are permitted provided that the following conditions are met:

- * Redistributions of source code must retain the above copyright notice, this list of conditions and the following disclaimer.
- * Redistributions in binary form must reproduce the above copyright notice, this list of conditions and the following disclaimer in the documentation and/or other materials provided with the distribution.
- * The name of Fabasoft R&D Software GmbH & Co KG or any of its subsidiaries, brand or product names may not be used to endorse or promote products derived from this software without specific prior written permission.

THIS SOFTWARE IS PROVIDED BY THE COPYRIGHT HOLDER ``AS IS" AND ANY EXPRESS OR IMPLIED WARRANTIES, INCLUDING, BUT NOT LIMITED TO, THE IMPLIED WARRANTIES OF MERCHANTABILITY AND FITNESS FOR A PARTICULAR PURPOSE ARE DISCLAIMED. IN NO EVENT SHALL THE COPYRIGHT HOLDER BE LIABLE FOR ANY DIRECT, INDIRECT, INCIDENTAL, SPECIAL, EXEMPLARY, OR CONSEQUENTIAL DAMAGES (INCLUDING, BUT NOT LIMITED TO, PROCUREMENT OF SUBSTITUTE GOODS OR SERVICES; LOSS OF USE, DATA, OR PROFITS; OR BUSINESS INTERRUPTION) HOWEVER CAUSED AND ON ANY THEORY OF LIABILITY, WHETHER IN CONTRACT, STRICT LIABILITY, OR TORT (INCLUDING NEGLIGENCE OR OTHERWISE) ARISING

IN ANY WAY OUT OF THE USE OF THIS SOFTWARE, EVEN IF ADVISED OF THE POSSIBILITY OF SUCH DAMAGE.

The following applies only to products supporting Wi-Fi.

(c) 2009-2013 by Jeff Mott. All rights reserved.

Redistribution and use in source and binary forms, with or without modification, are permitted provided that the following conditions are met:

- * Redistributions of source code must retain the above copyright notice, this list of conditions, and the following disclaimer.
- * Redistributions in binary form must reproduce the above copyright notice, this list of conditions, and the following disclaimer in the documentation or other materials provided with the distribution.
- * Neither the name CryptoJS nor the names of its contributors may be used to endorse or promote products derived from this software without specific prior written permission.

THIS SOFTWARE IS PROVIDED BY THE COPYRIGHT HOLDERS AND CONTRIBUTORS "AS IS," AND ANY EXPRESS OR IMPLIED WARRANTIES, INCLUDING, BUT NOT LIMITED TO, THE IMPLIED WARRANTIES OF MERCHANTABILITY AND FITNESS FOR A PARTICULAR PURPOSE, ARE DISCLAIMED. IN NO EVENT SHALL THE COPYRIGHT HOLDER OR CONTRIBUTORS BE LIABLE FOR ANY DIRECT, INDIRECT, INCIDENTAL, SPECIAL, EXEMPLARY, OR CONSEQUENTIAL DAMAGES (INCLUDING, BUT NOT LIMITED TO, PROCUREMENT OF SUBSTITUTE GOODS OR SERVICES; LOSS OF USE, DATA, OR PROFITS; OR BUSINESS INTERRUPTION) HOWEVER CAUSED AND ON ANY THEORY OF LIABILITY, WHETHER IN CONTRACT, STRICT LIABILITY, OR TORT (INCLUDING NEGLIGENCE OR OTHERWISE) ARISING IN ANY WAY OUT OF THE USE OF THIS SOFTWARE, EVEN IF ADVISED OF THE POSSIBILITY OF SUCH DAMAGE.

Enter keywords in the search window and click  (Search).

You can search for target pages in this guide.

Entry example: "(your product's model name) load paper"

Search Tips

You can search for target pages by entering keywords in the search window.

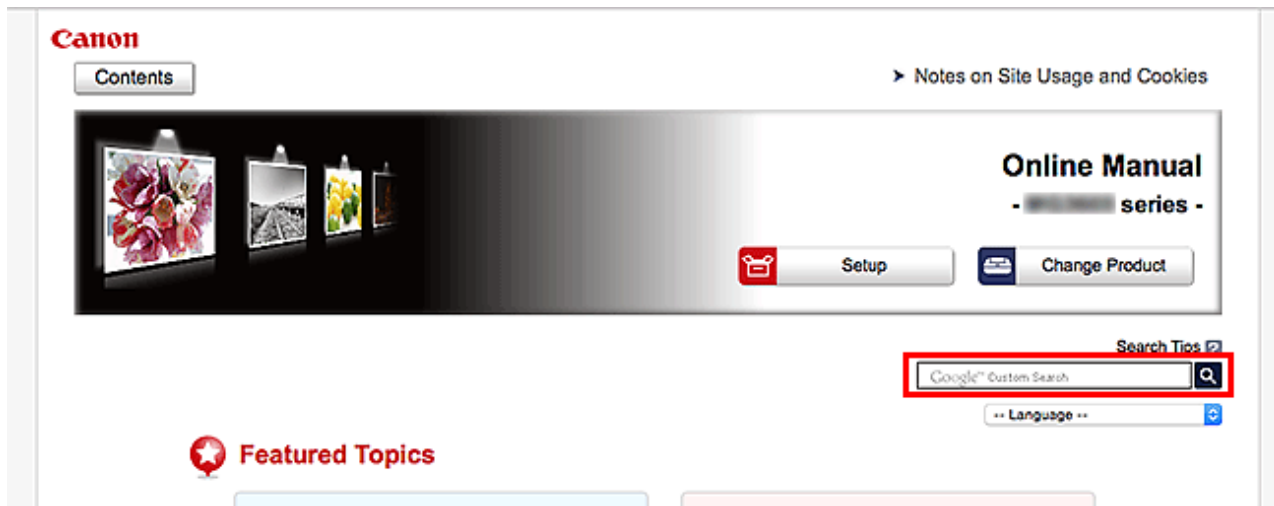

►►► Important

- This function may not be available in some countries/regions.

►►► Note

- The displayed screen may vary.
- When searching from this page without entering your product's model name or your application's name, all products supported by this guide will be considered for the search.
If you want to narrow down the search results, add your product's model name or your application's name to the keywords.

• Searching for Functions

Enter your product's model name and a keyword for the function you want to learn about

Example: When you want to learn how to load paper

Enter "(your product's model name) load paper" in the search window and perform a search

• Troubleshooting Errors

Enter your product's model name and a support code

Example: When the following error screen appears

Enter "(your product's model name) 1003" in the search window and perform a search

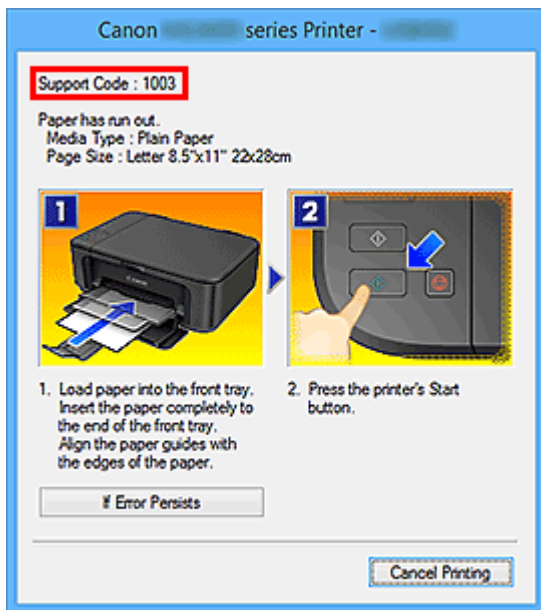

►►► Note

- The displayed screen varies depending on your product.

• **Searching for Application Functions**

Enter your application's name and a keyword for the function you want to learn about

Example: When you want to learn how to print collages with My Image Garden

Enter "My Image Garden collage" in the search window and perform a search

• **Searching for Reference Pages**

Enter your model name and a reference page title*

* You can find reference pages more easily by entering the function name as well.

Example: When you want to browse the page referred to by the following sentence on a scanning procedure page

Refer to "Color Settings Tab" for your model from Home of the *Online Manual* for details.

Enter "(your product's model name) scan Color Settings Tab" in the search window and perform a search

Using the Machine

- ▶ **Printing Photos from a Computer**
- ▶ **Copying Originals**

Printing Photos from a Computer

This section describes how to print photos with My Image Garden.

This section uses windows displayed when the Windows 8.1 operating system (hereinafter referred to as Windows 8.1) is used.

1. Open the paper support (A).
2. Pull out the paper output tray (B), then open the output tray extension (C).

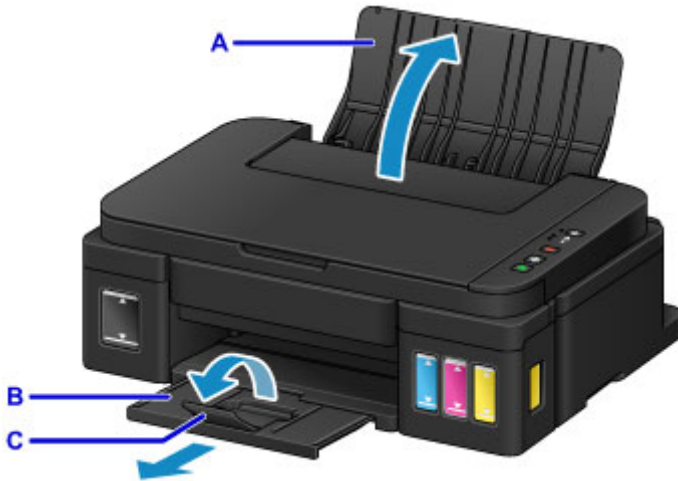

3. Load paper vertically WITH THE PRINT SIDE FACING YOU.
4. Align the paper guides (D) with the paper width.



5. Click the My Image Garden icon (E) in Quick Menu.

The **Guide Menu** screen is displayed.



►►► **Note**

- The number and types of icons displayed vary depending on your region, the registered printer/scanner and the installed applications.

6. Click the **Photo Print** icon (F).

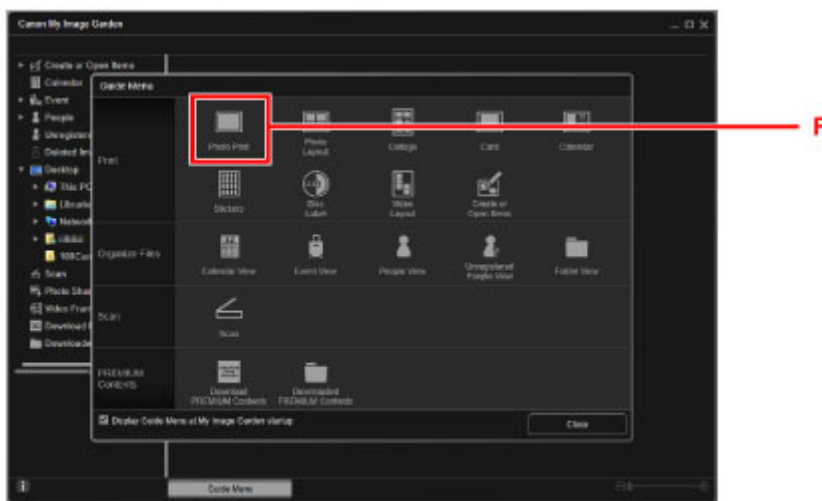

7. Click the folder (G) with photos you want to print.

8. Click the photos (H) you want to print.

For Windows:

To select two or more photos at a time, click photos while pressing the Ctrl key.

For Mac OS:

To select two or more photos at a time, click photos while pressing the command key.

9. Click **Print** (I).

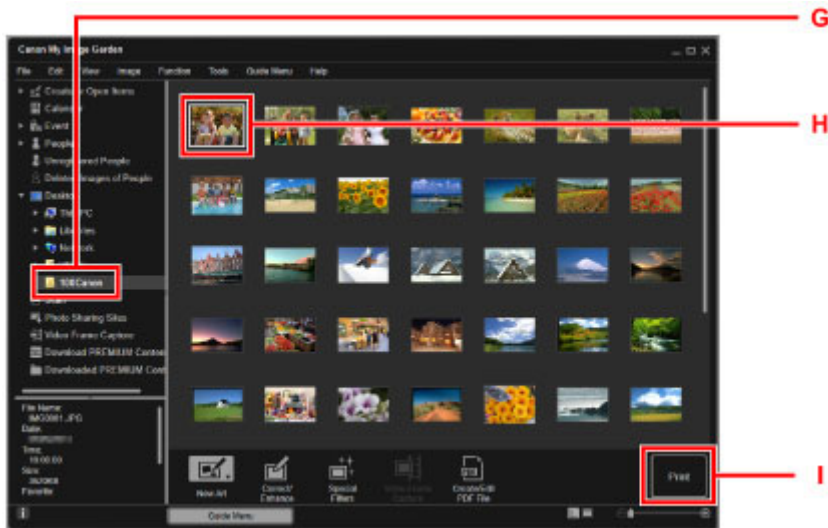

10. Specify the number of copies, your machine name, media type, etc. (J).

11. Click **Print** (K).

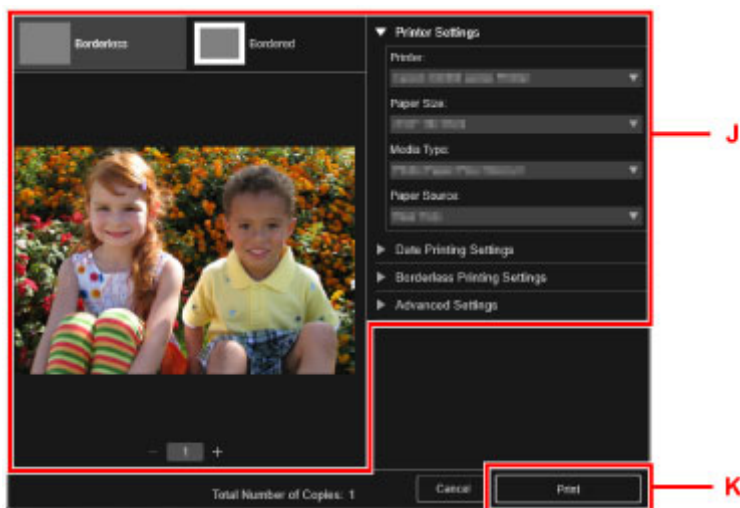

For Mac OS:

Click **OK** when the confirmation message appears, then click **Print**.

►►► Note

- My Image Garden lets you use images on your computer, such as photos taken with a digital camera, in a number of ways.

- My Image Garden Guide (Windows)
- My Image Garden Guide (Mac OS)

Copying Originals

This section describes how to load originals and copy them to plain paper.

1. Open the paper support (A).
2. Pull out the paper output tray (B), then open the output tray extension (C).

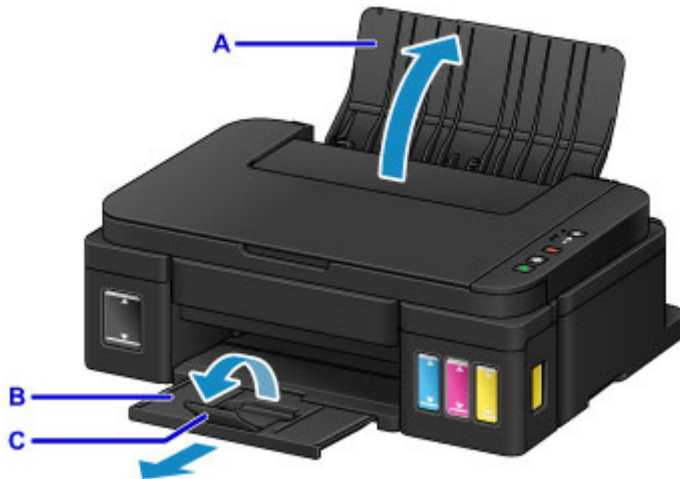

3. Load paper vertically WITH THE PRINT SIDE FACING YOU.
4. Align the paper guides (D) with the paper width.

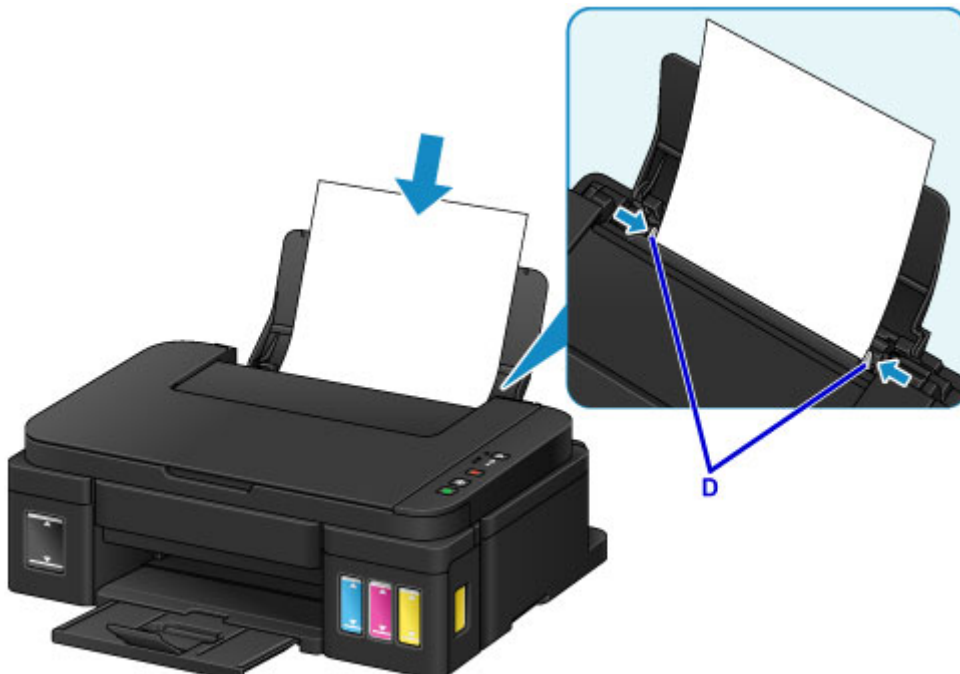

5. Open the document cover (E).

6. Load the original WITH THE SIDE TO COPY FACING DOWN and align it with the alignment mark (F).

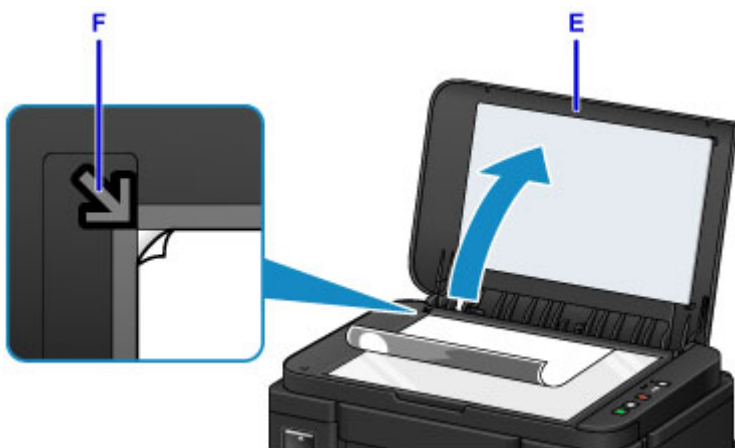

7. Close the document cover gently.
8. Press the **Black** button or **Color** button (G).



►► Important

- Do not open the document cover until copying is complete.

►► Note

- For details on copy features, refer to [Copying](#).

Printer Functions

- **Print Photos Easily Using My Image Garden**
- **Easy Scan with the Auto Function**
- **Scan Originals Larger than the Platen**
- **Scan Multiple Originals at One Time**
- **Online Storage Integration Function**

Print Photos Easily Using My Image Garden

Organize Images Easily

In My Image Garden, you can register the names of people and events to photos. You can organize photos easily as you can display them not only by folder but also by calendar, event, and person. This also allows you to find the target photos easily when you search for them later on.

<Calendar View>



<People View>

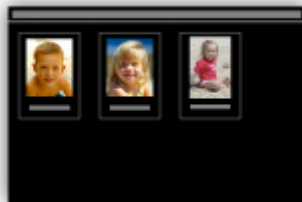

Display Recommended Items in Slide Shows

Based on the information registered to photos, Quick Menu automatically selects the photos on your computer and creates recommended items such as collages and cards. The created items appear in slide shows.



If there is an item you like, you can easily print it in just two steps.

1. In Image Display of Quick Menu, select the item you want to print.
2. Print the item with My Image Garden.



Place Photos Automatically

Delightful items are created easily as the selected photos are placed automatically according to the theme.



Other Various Functions

My Image Garden has many other useful functions.

Refer to the following for details.

- What You Can Do with My Image Garden (Windows)
- What You Can Do with My Image Garden (Mac OS)

Easy Scan with the Auto Function

By using the auto function of IJ Scan Utility, you can scan easily by automatically detecting the item type.

Refer to the following for details.

- Easy Scanning with Auto Scan (Windows)
- [Easy Scanning with Auto Scan](#) (Mac OS)

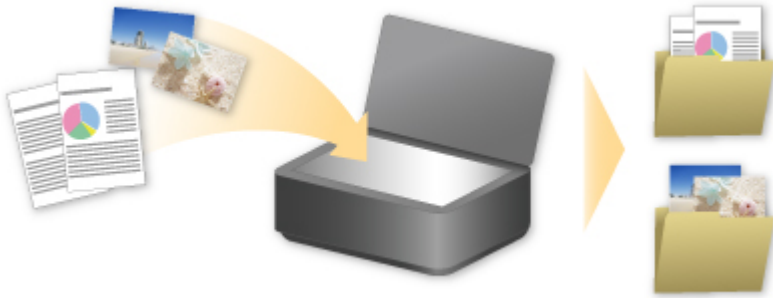

Scan Originals Larger than the Platen

By using the stitch function of IJ Scan Utility, you can scan the left and right halves of an item larger than the platen and combine them back into one image. Items up to approximately twice as large as the platen are supported.

Refer to the following for details.

- [Scanning Originals Larger than the Platen \(Image Stitch\) \(Windows\)](#)
- [Scanning Originals Larger than the Platen \(Image Stitch\) \(Mac OS\)](#)



Scan Multiple Originals at One Time

By using IJ Scan Utility, you can scan two or more photos (small items) placed on the platen at one time and save each image individually.

Refer to the following for details.

- [Scanning Multiple Originals at One Time \(Windows\)](#)
- [Scanning Multiple Originals at One Time \(Mac OS\)](#)

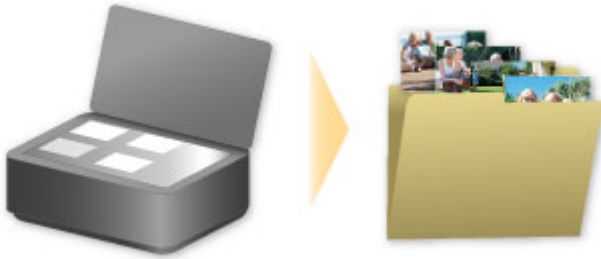

Online Storage Integration Function

The printer can integrate with online storage services such as Evernote.



Integration with Online Notetaking Service "Evernote"

If an Evernote client application is installed on your computer, you can import scanned images into the application and upload them to the Evernote server.

The uploaded images can be browsed from other computers, smartphones, etc.

To use Evernote, you need to create an account. See the "CREATE ACCOUNT" page of Evernote for account creation.

Settings

For Windows:

In the Settings Dialog Box of IJ Scan Utility, select the item you want to set, then select Evernote for **Send to an application** in **Application Settings**.

Refer to "Settings Dialog Box" for your model from Home of the *Online Manual* for details.

For Mac OS:

In the Settings Dialog of IJ Scan Utility, select the item you want to set, then select Evernote for **Send to an application** in **Application Settings**.

Refer to "Settings Dialog" for your model from Home of the *Online Manual* for details.

Important

- The Evernote service features are subject to change or termination without prior notice.

Handling Paper, Originals, Ink Tanks, etc.

▶ Loading Paper

- Loading Plain Paper / Photo Paper
- Loading Envelopes

▶ Loading Originals

- Loading Originals on the Platen Glass
- Originals You Can Load

▶ Refilling Ink Tanks

- Refilling Ink Tanks
- Checking Ink Status

Loading Paper

- ▶ **Loading Plain Paper / Photo Paper**
- ▶ **Loading Envelopes**

Loading Plain Paper / Photo Paper

You can load plain paper or photo paper.

▶▶▶ Important

- If you cut plain paper into small size such as 4" x 6" (10 x 15 cm), 5" x 7" (13 x 18 cm), Square 5" x 5" (13 x 13 cm), or Card 2.17" x 3.58" (55 x 91 mm) to perform trial print, it can cause paper jams.

▶▶▶ Note

- We recommend Canon genuine photo paper for printing photos.
For details on the Canon genuine paper, see [Media Types You Can Use](#).
- You can use general copy paper or Canon Red Label Superior WOP111/Canon Océ Office Colour Paper SAT213.
For the page size and paper weight you can use for this machine, see [Media Types You Can Use](#).

1. Prepare paper.

Align the edges of paper. If paper is curled, flatten it.

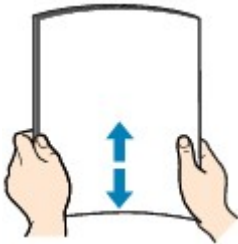

▶▶▶ Note

- Align the edges of paper neatly before loading. Loading paper without aligning the edges may cause paper jams.
- If paper is curled, hold the curled corners and gently bend them in the opposite direction until the paper becomes completely flat.
For details on how to flatten curled paper, see "Correct curl before loading paper." in [Paper Is Smudged / Printed Surface Is Scratched](#).
- When using Photo Paper Plus Semi-gloss SG-201, even if the sheet is curled, load one sheet at a time as it is. If you roll up this paper to flatten, this may cause cracks on the surface of the paper and reduce the print quality.

2. Open the paper support (A).

3. Pull out the paper output tray (B) and open the output tray extension (C).

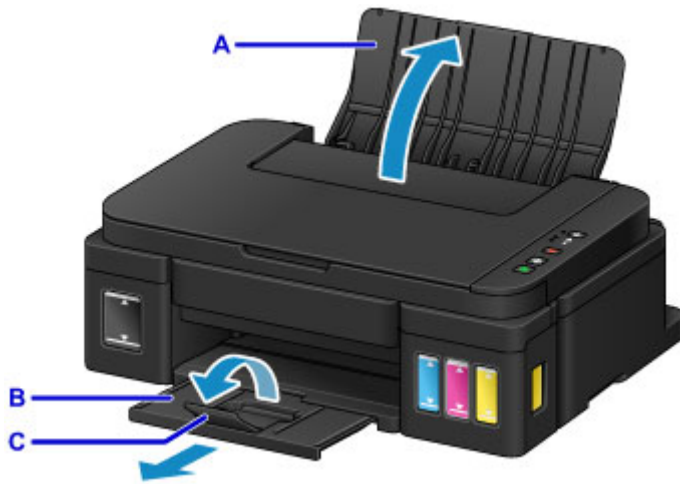

4. Slide the paper guides (D) to open them, and load the paper in the center of the rear tray WITH THE PRINT SIDE FACING YOU.

5. Slide the paper guides (D) to align them with both sides of the paper stack.

Do not slide the paper guides too hard against the paper. The paper may not be fed properly.

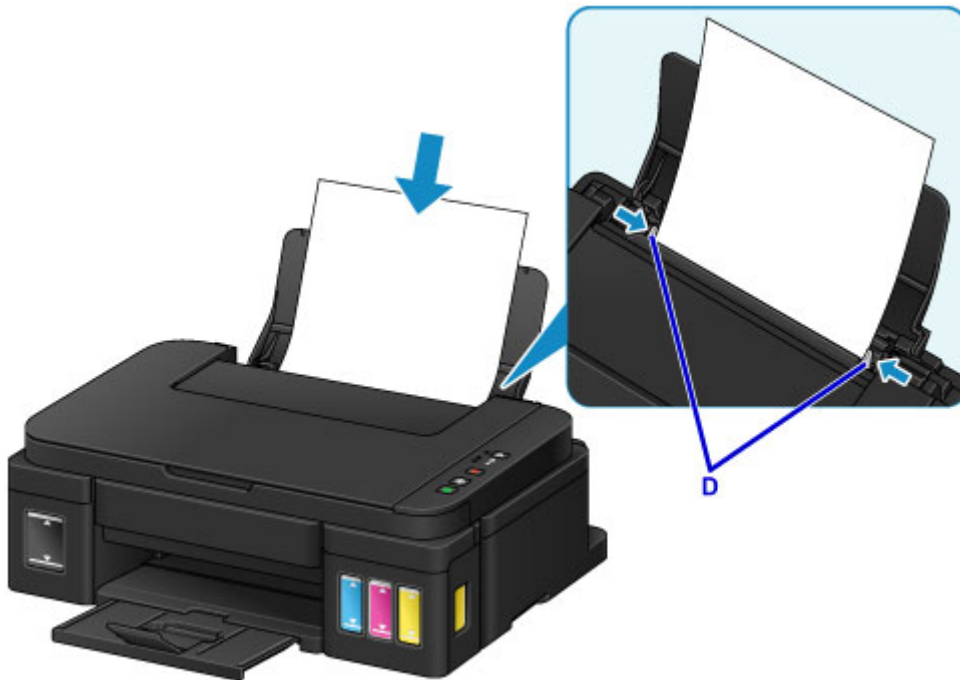

»» Important

- Always load paper in the portrait orientation (E). Loading paper in the landscape orientation (F) can cause paper jams.



E

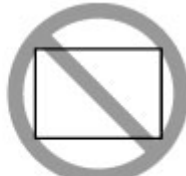

F

►►► **Note**

- Do not load sheets of paper higher than the load limit mark (G).

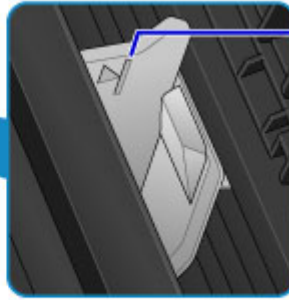
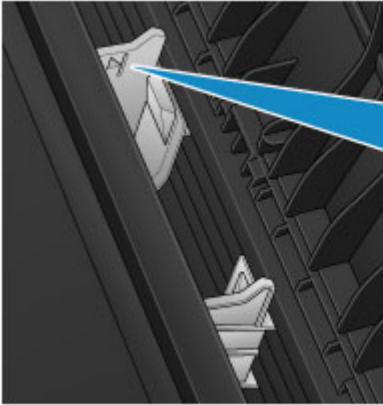

G

►►► **Note**

- When printing, select the size and type of the loaded paper on the print settings screen of the printer driver.

Loading Envelopes

You can load Envelope DL and Envelope Com 10.

The address is automatically rotated and printed according to the envelope's direction by specifying with the printer driver properly.

▶▶▶ Important

- Printing of envelopes from the operation panel is not supported.
- Do not use the following envelopes. They could jam in the machine or cause the machine to malfunction.
 - Envelopes with an embossed or treated surface
 - Envelopes with a double flap
 - Envelopes whose gummed flaps are already moistened and adhesive

1. Prepare envelopes.

- Press down on all four corners and edges of the envelopes to flatten them.

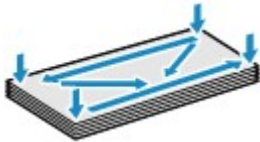

- If the envelopes are curled, hold the opposite corners and gently twist them in the opposite direction.



- If the corner of the envelope flap is folded, flatten it.
- Use a pen to press the leading edge in the inserting direction flat and sharpen the crease.

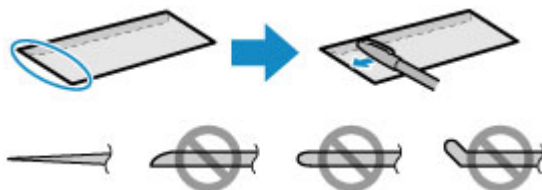

The figures above show a side view of the leading edge of the envelope.

▶▶▶ Important

- The envelopes may jam in the machine if they are not flat or the edges are not aligned. Make sure that no curl or puff exceeds 0.1 inch (3 mm).

2. Open the paper support (A).

3. Pull out the paper output tray (B) and open the output tray extension (C).

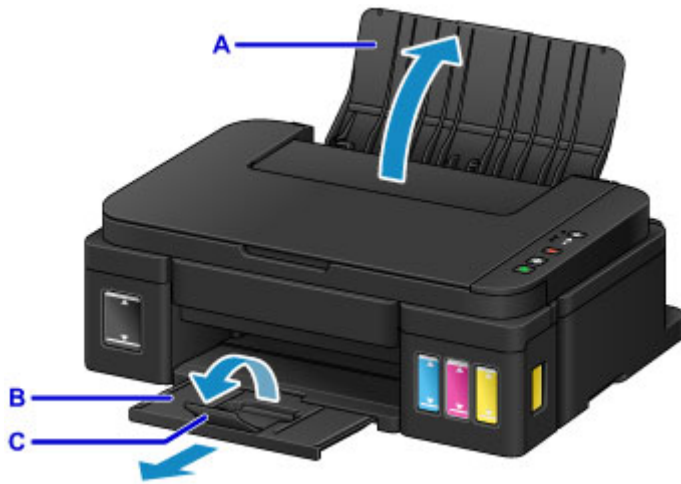

- Slide the paper guides (D) to open them, and load the envelopes in the center of the rear tray WITH THE ADDRESS SIDE FACING YOU.

The folded flap of the envelope will be faced down on the left side.

Up to 10 envelopes can be loaded at a time.

- Slide the paper guides (D) to align them with both sides of envelopes.

Do not slide the paper guides too hard against the envelopes. The envelopes may not be fed properly.

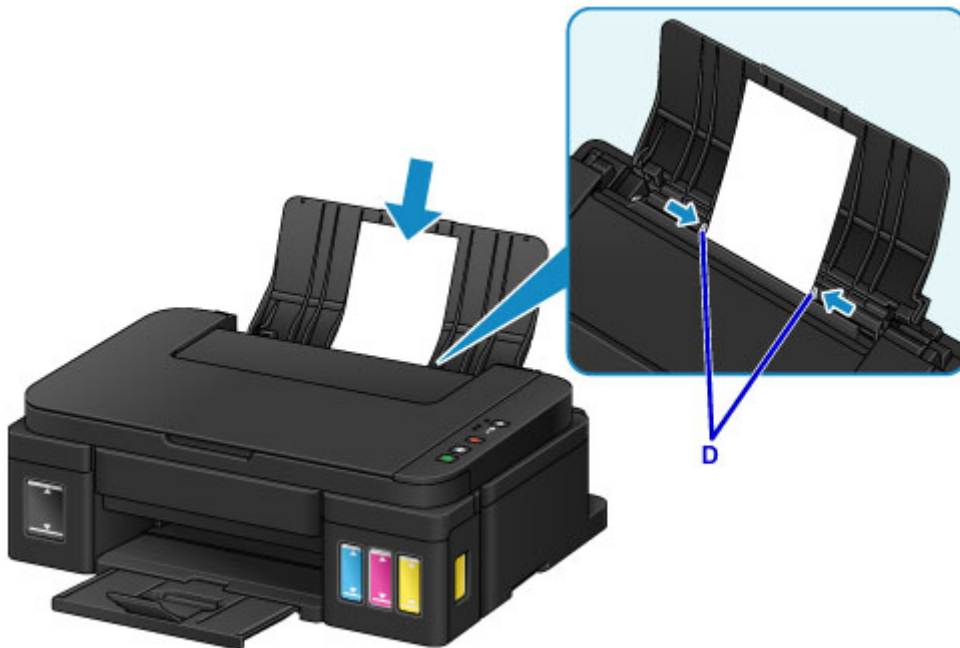

E



F

E: Rear side

F: Address side

▶▶▶ Note

- Do not load envelopes higher than the load limit mark (G).

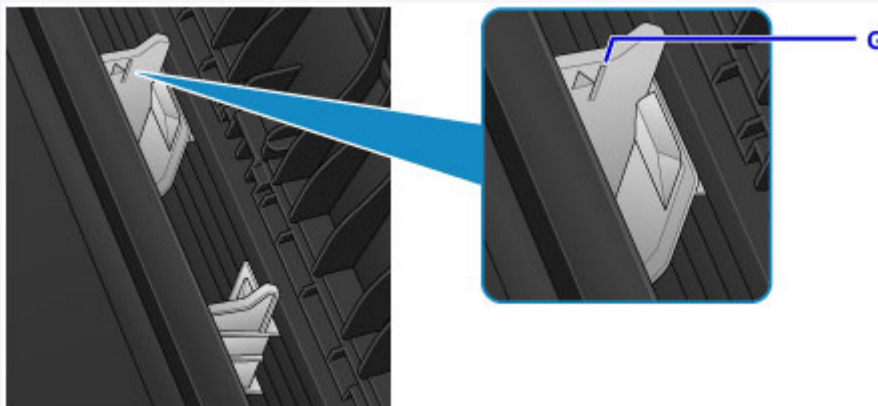

▶▶▶ Note

- When printing, select the size and type of the loaded envelopes on the print settings screen of the printer driver.

Loading Originals

- ▶ **Loading Originals on the Platen Glass**
- ▶ **Originals You Can Load**

Loading Originals on the Platen Glass

1. Open the document cover.
2. Load the original WITH THE SIDE TO SCAN FACING DOWN on the platen glass.

■ [Originals You Can Load](#)

Align the corner of the original with the alignment mark .



►► Important

- Be sure to observe the following when loading the original on the platen glass.
 - Do not place any objects weighing 4.4 lb (2.0 kg) or more on the platen glass.
 - Do not put any pressure of 4.4 lb (2.0 kg) or more on the platen glass, such as pressing down the original.

Failure to observe the above may cause the scanner to malfunction or the platen glass to break.

- The machine cannot scan the shaded area (A) (0.04 inch (1 mm) from the edges of the platen glass).

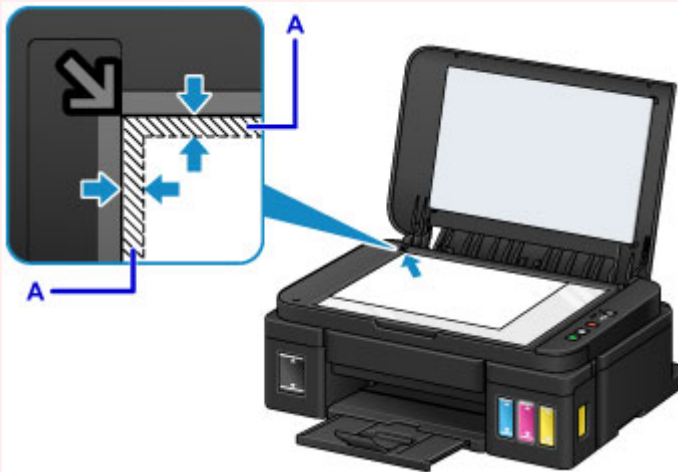

3. Close the document cover gently.



»» Important

- After loading the original on the platen glass, be sure to close the document cover before starting to copy or scan.

Originals You Can Load

Item	Details
Types of originals	- Text document, magazine, newspaper - Printed photo, postcard, business card, disc (BD/DVD/CD, etc.)
Size (width x height)	Max. 8.5 x 11.7 inches (216 x 297 mm)

Refilling Ink Tanks

- ▶ [Refilling Ink Tanks](#)
- ▶ [Checking Ink Status](#)

Refilling Ink Tanks

Check the remaining ink level with the ink tank indicator on the front of the machine. If the ink level is near the lower limit line (A), refill the ink tank.



►► Note

- If the function for notifying the remaining ink level (remaining ink level notification function) is enabled, the **Ink** lamp and the **Alarm** lamp inform you of the error when a remaining ink error occurs. Check the **Ink** lamp and the **Alarm** lamp statuses and take appropriate action.

- [An Error Occurs](#)

For details on the remaining ink level notification function, see below.

- [Changing the remaining ink level notification setting \(Windows\)](#)

- [Changing the remaining ink level notification setting \(Mac OS\)](#)

- If print results become faint or white streaks appear despite sufficient ink levels, see [Maintenance Procedure](#).
- For precautionary notes on handling ink bottles, see [Notes on ink bottles](#).

Refilling Procedure

When you need to refill an ink tank, follow the steps below.

►► Important

- Please ensure the printer remains flat after initial setup and is NOT turned upside down or on its side, as ink in the printer may leak.
- If the remaining ink level notification function is enabled, refill all four ink tanks until full. If the remaining ink level counter is reset when the ink tanks are not full, the machine cannot detect the ink level correctly.

1. Make sure the machine is on.
2. Open the scanning unit / cover (B) all the way until it stops.

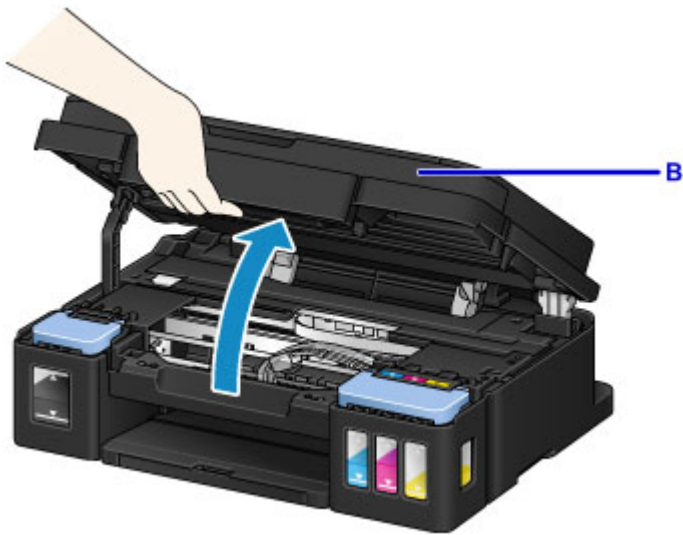

►► Important

- Do not place any object on the document cover. It will fall into the rear tray when the scanning unit / cover is opened and cause the machine to malfunction.
- Do not touch tubes or other parts inside the machine.

3. Open ink tank cover.

To refill the black ink tank, open the left ink tank cover (C).

To refill color ink tanks, open the right ink tank cover (D).



4. Grab and remove the tank cap (E) of the ink tank to be refilled.

Place the removed tank cap on the upper tank cap holder (F).

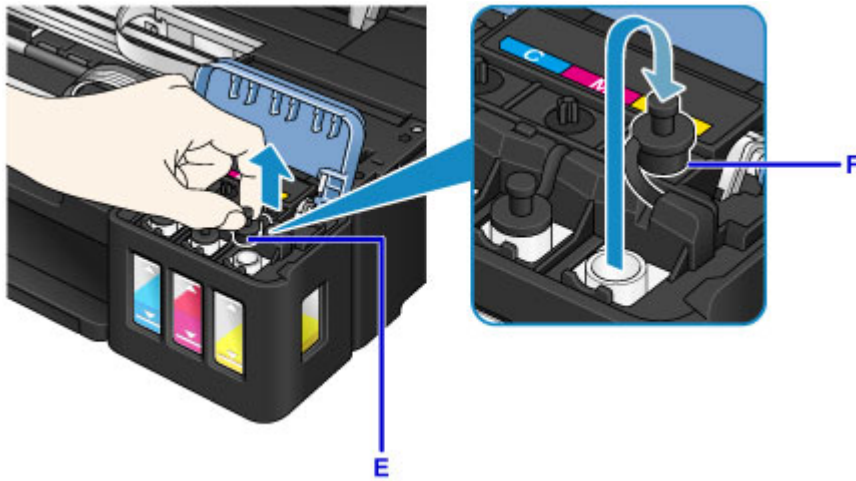

»» Important

- Carefully remove the tank cap of the ink tank. Ink on the inside of the tank cap may spatter when removing it.

5. Take a new ink bottle out of its package.

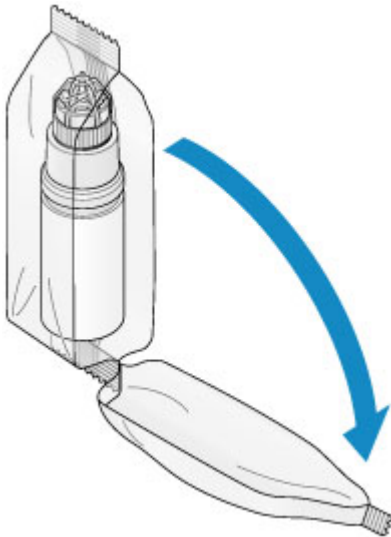

6. Hold the ink bottle upright and twist the bottle cap (G) to remove.

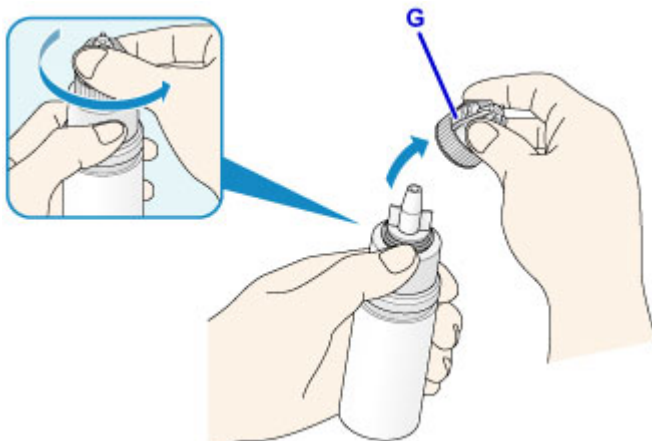

»» Important

- When removing the bottle cap, avoid squeezing the sides of the ink bottle. Hold the ink bottle as shown in the figure above. If you push the sides of the ink bottle, ink will spatter.
- Do not shake the ink bottle. Ink may spatter when opening the cap.
- Even if the ink bottle is dented, the ink contained in the bottle can still be used without problem.

7. Refill the ink tank.

Aligning the nozzle of the ink bottle with the bottle guide (H) on the machine, insert the nozzle into the inlet (I).

Next stand the ink bottle upside down and squeeze the sides of the ink bottle to refill the ink tank.

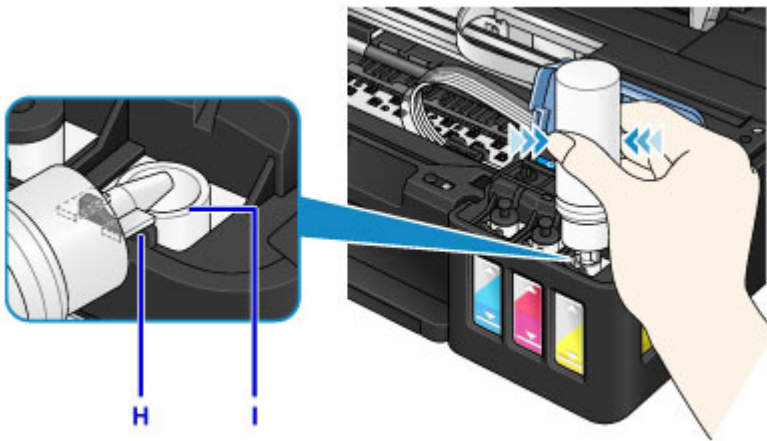

»» Important

- Make sure that each color of ink tanks is filled with corresponding color of ink bottles.
- When refilling ink tanks, do not squeeze the bottle sides too hard. Ink may spatter.
- Do not fill the ink tank above the ink tank's upper limit line (J). Ink above this line may spill over, causing malfunction or damage to the machine, and preventing the printing operation.

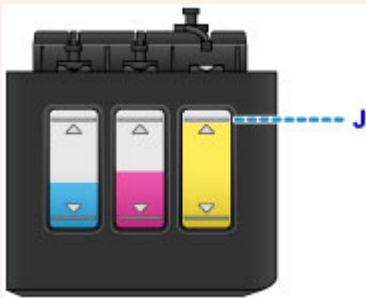

- Discard empty ink bottles in compliance with local laws and regulations regarding disposal of consumables.

8. Recap the inlet with the tank cap (E) of the ink tank.

Make sure the tank cap is completely inserted.

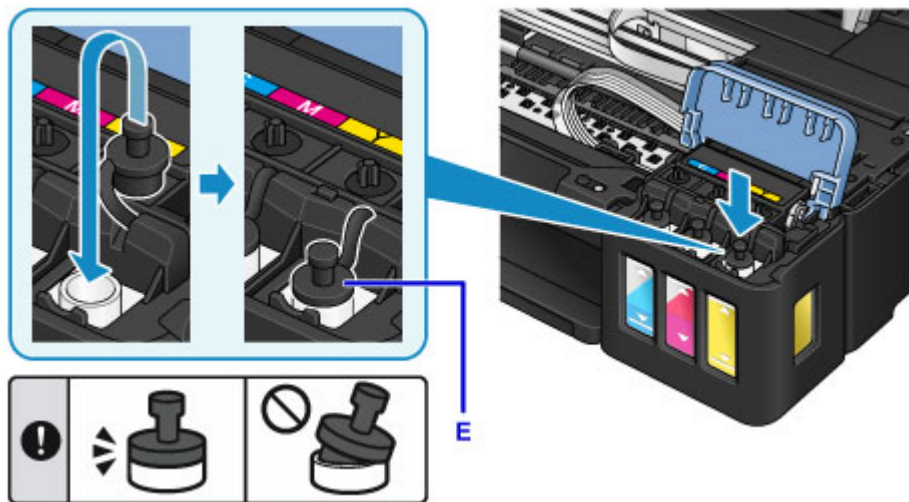

▶▶▶ Note

- When inserting the tank cap, be careful not to twist the tank cap rubber.

9. Close the ink tank cover.

▶▶▶ Important

- If you cannot properly close the ink tank cover, check if you forgot to insert any tank caps of the ink tanks. If the tank cap is left on the tank cap holder, the ink tank cover cannot be closed.

10. Lift the scanning unit / cover once, and then close it gently.



▶▶▶ Note

- If the remaining ink level notification function is enabled, the **Ink** lamp and the **Alarm** lamp are lit when ink runs out. This setting is enabled by default.
- If the lamps are lit, perform the following.

- To continue enabling the remaining ink level notification function

Hold down the **Black** button or the **Color** button for at least 5 seconds. The **Alarm** lamp goes off and the remaining ink level counter is reset.

- To disable the remaining ink level notification function

Press down and immediately release the **Black** button or the **Color** button. The **Alarm** lamp goes off and the remaining ink level notification function is disabled.

- You can also set the remaining ink level notification function or reset the remaining ink level counter from your computer.
 - [Changing the remaining ink level notification setting \(Windows\)](#)
 - [Changing the remaining ink level notification setting \(Mac OS\)](#)

►► Important

- If the remaining ink level notification function is disabled, check remaining ink levels and refill the ink tanks as necessary. Continuing printing with ink below the lower limit line of an ink tank may prevent satisfactory print quality or may cause malfunction or damage to the machine.

►► Note

- If the **Alarm** lamp flashes, take appropriate action.
 - [An Error Occurs](#)
- The machine may make noise during operation.

Notes on ink bottles

►► Important

- Keep out of reach of children.
- Do not drink ink.
- Be careful not to get any ink in your eyes or in your mouth. (In case of eye contact or swallowing, rinse with water and contact a doctor immediately).
- When you store ink bottles, close bottle caps completely and place bottles in standing position. If the ink bottles are laid down, ink may leak.
- When refilling ink tanks, take sufficient care to prevent ink from splattering onto surroundings.
- Ink may stain clothes or other belongings permanently. Washing may not remove ink stains.
- Do not use ink bottles and ink contained therein except to refill tanks of printers specified by Canon.
- Do not leave ink bottles in areas exposed to high temperature, such as near fire or a heater or in a car. Bottles may warp and cause ink leakage or ink may become poor quality.
- Do not subject ink bottles to impacts. Ink bottles may be damaged or bottle caps may come off by such impact, and ink may leak.
- Do not transfer ink to other containers. This may result in accidental ingestion, inappropriate use, or poor ink quality.
- Do not mix ink with water or other ink. This may damage the printer.
- Refill ink tanks quickly. Do not leave ink tanks with cap off.
- Once an ink bottle has been opened, do not leave it with bottle cap off. Ink will dry out, possibly preventing proper operation of the machine when an ink tank is refilled using this bottle.

►► Note

- Color ink may be consumed even when printing a black-and-white document or when black-and-white printing is specified. Every ink is also consumed in the standard cleaning and deep cleaning of the print head, which may be necessary to maintain the performance of the machine.

When an ink tank is out of ink, promptly refill it.

■ [Ink Tips](#)

Checking Ink Status

Check ink status with the ink tank indicator on the front of the machine.

When ink reaches the upper limit line (A), ink is full.

When ink is near the lower limit line (B), ink is running low. Refill the ink tank.

▶▶▶ Note

- To check the remaining ink level, visually inspect the remaining ink in the ink tank.



▶▶▶ Important

- If printing is continued when the remaining ink level is below the lower limit line, the printer may consume a certain amount of ink to return to printable status and may also become damaged.

▶▶▶ Note

- This machine has a function for notifying the remaining ink level, called the remaining ink level notification function. When the remaining ink level notification function is enabled, refill all ink tanks until ink reaches the upper limit line (A). If ink does not reach the upper limit line, the remaining ink level is not detected correctly.
 - Changing the remaining ink level notification setting (Windows)
 - [Changing the remaining ink level notification setting](#) (Mac OS)
- If a remaining ink error occurs, the **Ink** lamp and the **Alarm** lamp will flash to inform you of the error. Count the number of flashes of the **Ink** lamp and take appropriate action.
 - [An Error Occurs](#)
- The remaining ink level notification function works from initial printing to the time when one of the inks reaches the lower limit line shown on the ink tank. For the remaining ink level notification function to work appropriately, each ink tank must be filled with entire contents of the corresponding color ink bottle bundled with the printer before printing. After the initial filling, if either of the ink tanks is refilled before the remaining ink level reaches the lower limit line, a significant error may occur in the accuracy of the remaining ink level notification function. If you want to refill an ink tank before the remaining ink level reaches the lower limit line, be sure to follow the procedure in the manual.
- To ensure you receive premium print quality and to help protect your print head, a certain amount of ink remains in the ink tank when the printer indicates to refill the ink tank. The estimated page yields of the ink bottle do not include this amount.

If the remaining ink level notification function is enabled

You can check if ink has run out with the **Ink** lamp.

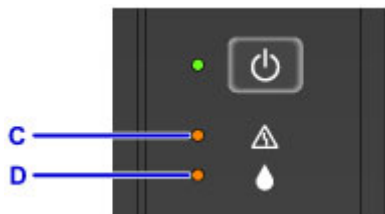

C: **Alarm** lamp

D: **Ink** lamp

Ink lamp lights and Alarm lamp lights:

Color ink and/or black ink has run out.

Refill ink tanks with ink.

▶▶▶ Note

- For details on the remaining ink level notification function, see below.
 - [Changing the remaining ink level notification setting \(Windows\)](#)
 - [Changing the remaining ink level notification setting \(Mac OS\)](#)

Maintenance

- ▶ **If Printing Is Faint or Uneven**
- ▶ **Performing Maintenance Functions from Your Computer (Windows)**
- ▶ **Performing Maintenance Functions from Your Computer (Mac OS)**
- ▶ **Cleaning**

If Printing Is Faint or Uneven

- **Maintenance Procedure**
- **Printing the Nozzle Check Pattern**
- **Examining the Nozzle Check Pattern**
- **Cleaning the Print Head**
- **Cleaning the Print Head Deeply**
- **Aligning the Print Head**

Maintenance Procedure

If print results are blurred, colors are not printed correctly, or print results are unsatisfactory (e.g. misaligned printed ruled lines), perform the maintenance procedure below.

▶▶▶ Important

- Do not rinse or wipe the print head. This can cause cartridge problems.

▶▶▶ Note

- Check the remaining ink level.
If the ink level is low, take appropriate action.
 - [Checking Ink Status](#)
- If the **Alarm** lamp is on or flashing, see [An Error Occurs](#).
- Increasing the print quality in the printer driver settings may improve the print result.
 - [Changing the Print Quality and Correcting Image Data \(Windows\)](#)
 - [Changing the Print Quality and Correcting Image Data \(Mac OS\)](#)

When the Print Results Are Blurred or Uneven:

Step1 Print the nozzle check pattern.

From the machine

- [Printing the Nozzle Check Pattern](#)

From the computer

- [Printing a Nozzle Check Pattern \(Windows\)](#)
- [Printing a Nozzle Check Pattern \(Mac OS\)](#)

Step2 [Examine the nozzle check pattern](#).

If there are missing lines or horizontal white streaks in the pattern:



Step3 Clean the print head.

From the machine

- [Cleaning the Print Head](#)

From the computer

- [Cleaning the Print Heads \(Windows\)](#)
- [Cleaning the Print Heads \(Mac OS\)](#)

After cleaning the print head, print and examine the nozzle check pattern: ➔ [Step1](#)

If the problem is not resolved after performing from step 1 to step 3 twice:



|| Step4 Clean the print head deeply.

From the machine

- [Cleaning the Print Head Deeply](#)

From the computer

- [Cleaning the Print Heads \(Windows\)](#)
- [Cleaning the Print Heads \(Mac OS\)](#)

▶▶▶ Note

- If problem is not resolved after performing print head deep cleaning, perform system cleaning from a computer.

- [Cleaning the Print Heads \(Windows\)](#)
- [Cleaning the Print Heads \(Mac OS\)](#)

If the problem is still not resolved, the print head may be damaged. Contact the service center.

When the Print Results Are Not Even such as the Ruled Lines Are Misaligned:

|| Step Align the print head.

From the machine

- [Aligning the Print Head](#)

From the computer

- [Aligning the Print Head Position Automatically \(Windows\)](#)
- [Aligning the Print Head Position Automatically \(Mac OS\)](#)

Printing the Nozzle Check Pattern

Print the nozzle check pattern to determine whether the ink ejects properly from the print head nozzle.

▶▶▶ Note

- If the remaining ink level is low, the nozzle check pattern will not be printed correctly. [Refill any ink tanks](#) that are low.

You need to prepare: a single sheet of A4 or Letter-sized plain paper

1. Make sure that the power is turned on.
2. Load a single sheet of A4 or Letter-sized plain paper in the rear tray.
3. Pull out the paper output tray, then open the output tray extension.
4. Hold down the **Stop** button until the **Alarm** lamp flashes once, then release it immediately.

The nozzle check pattern will be printed.

Do not perform any other operations until the machine completes the printing of the nozzle check pattern.

5. [Examine the nozzle check pattern.](#)

Examining the Nozzle Check Pattern

Examine the nozzle check pattern, and clean the print head if necessary.

1. Check if there are missing lines in pattern A or horizontal white streaks in pattern B.

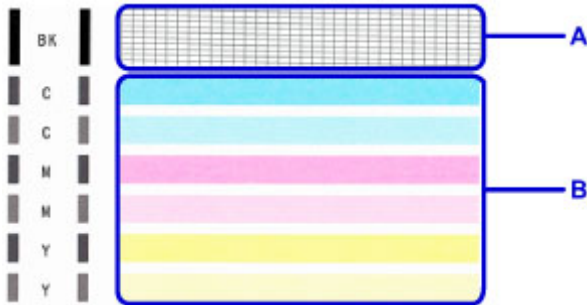

If there are missing lines in pattern A:

[Cleaning the print head](#) is required.



C: Good

D: Bad (lines are missing)

If there are horizontal white streaks in pattern B:

[Cleaning the print head](#) is required.



E: Good

F: Bad (horizontal white streaks are present)

Cleaning the Print Head

Clean the print head if lines are missing or if horizontal white streaks are present in the printed nozzle check pattern. Cleaning unclogs the nozzles and restores the print head condition. Cleaning the print head consumes ink, so clean the print head only when necessary.

1. Make sure that the power is turned on.
2. Hold down the **Stop** button until the **Alarm** lamp flashes twice, then release it immediately.

The machine starts cleaning the print head.

The cleaning will be complete when the **ON** lamp lights after flashing.

Do not perform any other operations until the machine completes the cleaning of the print head. This takes about 1 minute.

3. Check the print head condition.

To check the print head condition, [print the nozzle check pattern](#).

▶▶ Note

- If the problem is not resolved after cleaning the print head twice, [clean the print head deeply](#).

Cleaning the Print Head Deeply

If print quality does not improve by the standard cleaning of the print head, clean the print head deeply. Cleaning the print head deeply consumes more ink than the standard cleaning of the print head, so clean the print head deeply only when necessary.

1. Make sure that the power is turned on.
2. Hold down the **Stop** button until the **Alarm** lamp flashes three times, then release it immediately.

The machine starts cleaning the print head deeply.

The cleaning will be complete when the **ON** lamp lights after flashing.

Do not perform any other operations until the machine completes the deep cleaning of the print head. This takes about 3 minutes.

3. Check the print head condition.

To check the print head condition, [print the nozzle check pattern](#).

Aligning the Print Head

If printed ruled lines are misaligned or print results are otherwise unsatisfactory, adjust the print head position.

▶▶▶ Note

- If the remaining ink level is low, the print head alignment sheet will not be printed correctly.
[Refill any ink tanks](#) that are low.

You need to prepare: a single sheet of A4 or Letter-sized plain paper (including recycled paper)*

* Be sure to use paper that is white and clean on both sides.

1. Make sure that the power is turned on.
2. Load a single sheet of A4 or Letter-sized plain paper in the rear tray.
3. Pull out the paper output tray, then open the output tray extension.
4. Hold down the **Stop** button until the **Alarm** lamp flashes eight times, then release it immediately.

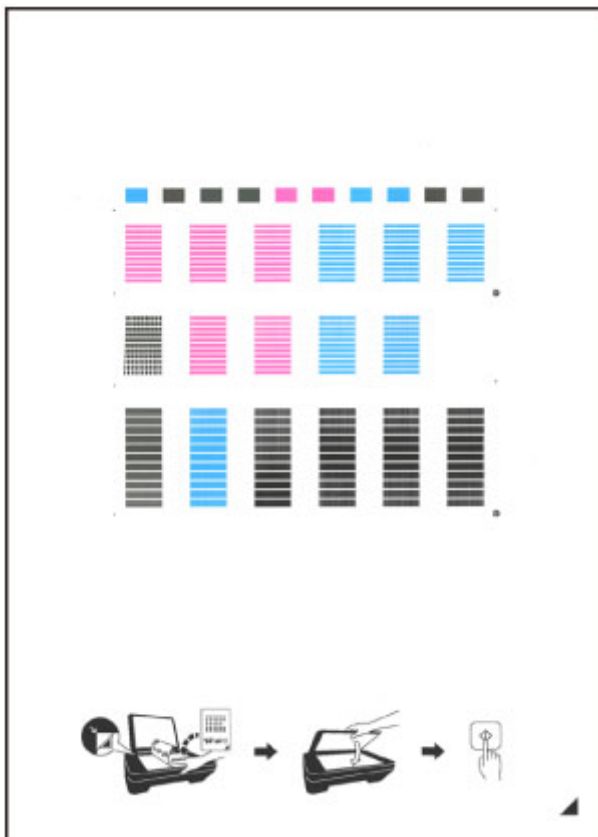

The print head alignment sheet will be printed.



»» Important

- Do not touch any printed part on the print head alignment sheet. If the sheet is stained or wrinkled, it may not be scanned properly.
- If the print head alignment sheet was not printed correctly, press the **Stop** button, then redo this procedure from the beginning.

5. Load the print head alignment sheet on the platen glass.

Load the print head alignment sheet WITH THE PRINTED SIDE FACING DOWN and align the mark  on the bottom right corner of the sheet with the alignment mark .



6. Close the document cover gently, then press the **Black** or **Color** button.

The machine starts scanning the print head alignment sheet, and the print head position will be adjusted automatically.

The print head position adjustment will be complete when the **ON** lamp lights after flashing.

Remove the print head alignment sheet on the platen glass.

»» Important

- Do not open the document cover or move the print head alignment sheet on the platen glass until adjusting the print head position is complete.
- If adjusting the print head position has failed, the **Alarm** lamp flashes. Press the **Black** or **Color** button to release the error, then take appropriate action.

 [An Error Occurs](#)

»» Note

- If the print results are still not satisfactory after adjusting the print head position as described above, adjust the print head position manually from the computer.
 - [Aligning the Print Head Position \(Windows\)](#)
 - [Aligning the Print Head Position \(Mac OS\)](#)
- To print and check the current head position adjustment values, hold down the **Stop** button until the **Alarm** lamp flashes ten times, then release it immediately.

Performing Maintenance Functions from Your Computer (Mac OS)

- **Cleaning the Print Heads**
- **Cleaning Inside the Printer**
- **Cleaning the Paper Feed Rollers**
- **Printing a Nozzle Check Pattern**
- **Aligning the Print Head**
- **Aligning the Print Head Position Automatically**
- **Aligning the Print Head Position**

Cleaning the Print Heads

The print head cleaning and deep cleaning functions allow you to clear up clogged print head nozzle. Perform print head cleaning if printing is faint or a specific color fails to print, even though there is enough ink.

If you perform deep cleaning and the condition still does not improve, perform system cleaning.

The procedure for cleaning is as follows:



Cleaning

1. Select **Cleaning** from the pop-up menu on the [Canon IJ Printer Utility](#)

2. Click the **Cleaning** icon

When the dialog opens, select the ink group for which cleaning is to be performed.

Before running **Cleaning**, check that the printer power is on.

Then check the following item:

- [Is there ink remaining?](#)

3. Execute cleaning

Make sure that the printer is on and then click **OK**.

Print head cleaning starts.

4. Complete cleaning

Next, the message for nozzle check pattern printing is displayed.

5. Check the results

To check whether the print quality has improved, click **Print Check Pattern**. To cancel the check process, click **Cancel**.

If cleaning the head once does not resolve the print head problem, clean it once more.

Important

- **Cleaning** consumes a small amount of ink. Cleaning the print head frequently will rapidly deplete your printer's ink supply. Consequently, perform cleaning only when necessary.



Deep Cleaning

Deep Cleaning is more thorough than cleaning. Perform deep cleaning when two **Cleaning** attempts do not resolve the print head problem.

1. Select **Cleaning** from the pop-up menu on the [Canon IJ Printer Utility](#)

2. Click the **Deep Cleaning** icon

When the dialog opens, select the ink group for which deep cleaning is to be performed.

Before running **Deep Cleaning**, check that the printer power is on.

Then check the following item:

- [Is there ink remaining?](#)

3. Execute deep cleaning

Make sure that the printer is on and then click **OK**.

Click **OK** when the confirmation message appears.

Print head deep cleaning starts.

4. Complete deep cleaning

Next, the message for nozzle check pattern printing is displayed.

5. Check the results

To check whether the print quality has improved, click **Print Check Pattern**. To cancel the check process, click **Cancel**.

»» Important

- **Deep Cleaning** consumes a larger amount of ink than **Cleaning**.
Cleaning the print head frequently will rapidly deplete your printer's ink supply. Consequently, perform cleaning only when necessary.



System Cleaning

Execute **System Cleaning** if the status does not improve even after **Deep Cleaning** is performed.

1. Select **Cleaning** from the pop-up menu on the [Canon IJ Printer Utility](#)

2. Click the **System Cleaning** icon

When the dialog opens, select the ink group for which system cleaning is to be performed.

Before running **System Cleaning**, check that the printer power is on.

Then check the following items:

- When you ran **Nozzle Check**, were there areas where the print was smeared or unprinted areas?
- Did the condition not improve even after **Deep Cleaning** was run?
- Are the remaining ink levels insufficient?

- Visually check whether the remaining ink levels are insufficient.
If **System Cleaning** is run when the remaining ink levels are insufficient, it may trigger a failure.
- If you selected **All Colors** or **Black for Ink Group**, check that all remaining ink levels are at least at the single dot position indicated on the ink tanks. (The color inks are consumed even if **Black** was selected.)
If you selected **Color**, check that the remaining ink levels for all color inks are at least at the single dot position indicated on the ink tanks.
- If any remaining ink level is below the single dot position, [replenish](#) the ink to at least the single dot position. However, if **Remaining Ink Notification Settings** is enabled, replenish all remaining ink levels to the upper limit line indicated on the ink tanks, regardless of the **Ink Group** setting.

3. Execute system cleaning

Make sure that the printer is on and then click **OK**.
Click **OK** when the confirmation message appears.
System cleaning starts.

4. Complete system cleaning

Next, the message for nozzle check pattern printing is displayed.

5. Check the results

To check whether the print quality has improved, click **Print Check Pattern**. To cancel the check process, click **Cancel**.

»» Important

- **System Cleaning** consumes an extremely large amount of ink.
Executing system cleaning frequently will rapidly deplete your printer's ink supply. Therefore, execute system cleaning only when necessary.
- If **System Cleaning** is run when the remaining ink level is insufficient, it may cause a failure.
Be sure to check the remaining ink level before running **System Cleaning**.

»» Note

- If there is no sign of improvement after **System Cleaning**, turn off the printer, wait 24 hours, and then perform **Deep Cleaning** again. If there is still no sign of improvement, the ink may have run out or the print head may be worn. For details on the remedial action to be taken, see "No Ink Comes Out."

Related Topic

- [Use Your Computer to Print a Nozzle Check Pattern](#)

Cleaning Inside the Printer

To prevent smudges on the back side of the paper, perform bottom plate cleaning.

Also perform bottom plate cleaning if ink smudges caused by something other than print data appear on the printed page.

The procedure for performing bottom plate cleaning is as follows:



Bottom Plate Cleaning

1. Select **Cleaning** from the pop-up menu on the [Canon IJ Printer Utility](#)
2. Click the **Bottom Plate Cleaning** icon

The dialog opens.

3. [Load paper](#) in the printer

As instructed in the dialog, fold the A4 size or Letter size plain paper in half horizontally, and then unfold the sheet.

Load the paper into the rear tray in the portrait orientation with the crest of the crease facing down.

4. Perform the bottom plate cleaning

Make sure that the printer is on and then click **OK**.

Bottom plate cleaning starts.

Cleaning the Paper Feed Rollers

Cleans the paper feed rollers. Perform feed roller cleaning when there are paper particles sticking to the paper feed rollers and paper is not fed properly.

The procedure for performing the feed roller cleaning is as follows:



Roller Cleaning

1. Prepare the printer

Remove all sheets of paper from the rear tray.

2. Select **Cleaning** from the pop-up menu on the [Canon IJ Printer Utility](#)

3. Click the **Roller Cleaning** icon

The confirmation message appears.

4. Execute paper feed roller cleaning

Make sure that the printer is on and then click **OK**.

Paper feed roller cleaning starts.

5. Complete paper feed roller cleaning

After the rollers have stopped, follow the instruction in the message, load three sheets of plain paper into the rear tray, and click **OK**.

Paper will be ejected and feed roller cleaning will be completed.

Printing a Nozzle Check Pattern

The nozzle check function allows you to check whether the print head is working properly by printing a nozzle check pattern. Print the pattern if printing becomes faint, or if a specific color fails to print.

The procedure for printing a nozzle check pattern is as follows:



Nozzle Check

1. Select **Test Print** from the pop-up menu on the [Canon IJ Printer Utility](#)

2. Click the **Nozzle Check** icon

The confirmation message appears.

Before running **Nozzle Check**, check that the printer power is on.

Then check the following item:

- [Is there ink remaining?](#)

3. Load paper in the printer

Load one sheet of A4 size or Letter size plain paper into the rear tray.

4. Print a nozzle check pattern

Make sure that the printer is on and click **Print Check Pattern**.

Printing of the nozzle check pattern begins.

5. Check the print result

When the dialog opens, check the print result. If the print result is normal, click **Quit**.

If the print result is smudged or if there are any unprinted sections, click **Cleaning** to clean the print head.

Related Topic

- [Cleaning the Print Heads](#)

Aligning the Print Head

When you perform head position adjustment, errors in the print head adjustment position are corrected and conditions such as color and line streaking are improved.

If the print results appear uneven because of line shifts or other conditions, adjust the position of the print head.

On this printer, you can adjust the print head either [automatically](#) or [manually](#).

Aligning the Print Head Position

Print head alignment corrects the installation positions of the print head and improves deviated colors and lines.

This printer supports two head alignment methods: [automatic head alignment](#) and manual head alignment.

The procedure for performing manual print head alignment is as follows:



Print Head Alignment

1. Select **Custom Settings** from the pop-up menu on the [Canon IJ Printer Utility](#)
2. Switch head alignment to manual
Check the **Align heads manually** check box.
3. Apply the settings
Click **Apply** and when the confirmation message appears, click **OK**.
4. Select **Test Print** from the pop-up menu on the [Canon IJ Printer Utility](#)
5. Click the **Print Head Alignment** icon
A message is displayed.
6. Load paper in the printer
Load two sheets of A4 size or Letter size plain paper into the rear tray.
7. Execute head alignment
Make sure that the printer is on and click **Align Print Head**.
The first pattern is printed.
»» Important
 - Do not open the scanning unit / cover while printing is in progress.
8. Check the printed pattern
Enter the numbers of the patterns with the least noticeable streaks or stripes in the associated boxes, and click **OK**.

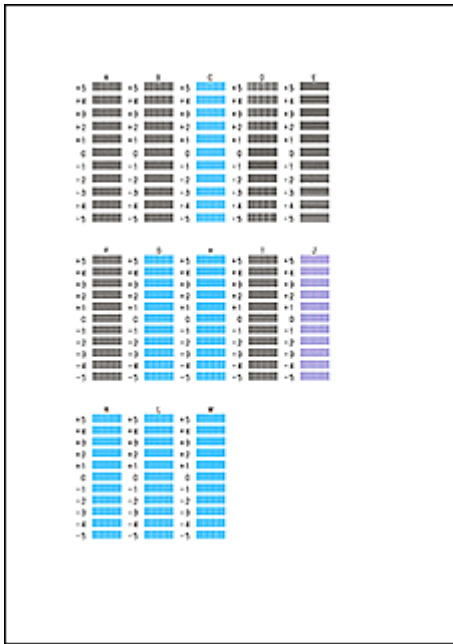

➤➤➤ **Note**

- If it is difficult to pick the best pattern, pick the setting that produces the least noticeable vertical streaks.



(A)



(B)

(A) Least noticeable vertical streaks

(B) Most noticeable vertical streaks

- If it is difficult to pick the best pattern, pick the setting that produces the least noticeable horizontal stripes.



(A)



(B)

(A) Least noticeable horizontal stripes

(B) Most noticeable horizontal stripes

9. Confirm the displayed message and click **OK**

The second pattern is printed.

➤➤➤ **Important**

- Do not open the scanning unit / cover while printing is in progress.

10. Check the printed pattern

Enter the numbers of the patterns with the least noticeable stripes in the associated boxes, and click **OK**.

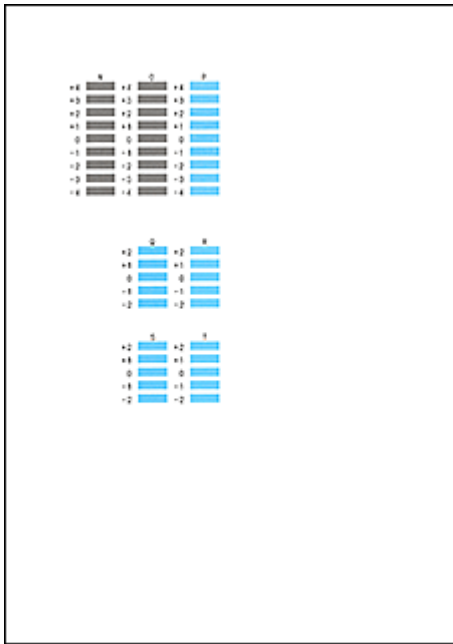

➤➤➤ **Note**

- If it is difficult to pick the best pattern, pick the setting that produces the least noticeable horizontal stripes.



(A)



(B)

(A) Least noticeable horizontal stripes

(B) Most noticeable horizontal stripes

➤➤➤ **Note**

- After head alignment is completed, you can print and check the current setting. To do so, click the **Print Head Alignment** icon and when the message is displayed, click **Print Alignment Value**.

Aligning the Print Head Position Automatically

Print head alignment corrects the installation positions of the print head and improves deviated colors and lines.

This printer supports two head alignment methods: automatic head alignment and manual head alignment. Normally, the printer is set for automatic head alignment. If the printing results of automatic print head alignment are not satisfactory, [perform manual head alignment](#).

The procedure for performing automatic print head alignment is as follows:

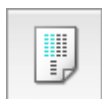

Print Head Alignment

1. Select **Test Print** from the pop-up menu on the [Canon IJ Printer Utility](#)

2. Click the **Print Head Alignment** icon

A message is displayed.

3. Load paper in the printer

Load one sheet of A4 size or Letter size plain paper into the rear tray.

▶▶▶ Note

- The number of sheets to be used differs when you select the manual head alignment.

4. Print head alignment pattern printing

Make sure that the printer is on and click **Align Print Head**.

The adjustment pattern is printed.

▶▶▶ Important

- Do not open the scanning unit / cover while printing is in progress.

5. Adjustment pattern scanning

After the adjustment pattern is printed, a message is displayed.

Load the adjustment pattern onto the platen, and press the **Start** button on the printer.

Print head alignment starts.

▶▶▶ Note

- After head alignment is completed, you can print and check the current setting. To do so, click the **Print Head Alignment** icon and when the message is displayed, click **Print Alignment Value**.

Cleaning

- ▶ **Cleaning the Exterior of the Machine**
- ▶ **Cleaning the Platen Glass and Document Cover**
- ▶ **Cleaning the Paper Feed Roller**
- ▶ **Cleaning the Inside of the Machine (Bottom Plate Cleaning)**

Cleaning the Exterior of the Machine

Be sure to use a soft and dry cloth such as eyeglasses cleaning cloth and wipe off dirt on the surface gently. Smooth out wrinkles on the cloth if necessary before cleaning.

»» Important

- Be sure to turn off the power and unplug the power cord before cleaning the machine.
- Do not use tissue paper, paper towels, rough-textured cloth, or similar materials for cleaning so as not to scratch the surface. Paper tissue powder or fine threads may remain inside the machine and cause problems such as print head blockage and poor printing results.
- Never use volatile liquids such as thinners, benzene, acetone, or any other chemical cleaner to clean the machine, as this may cause a malfunction or damage the surface of the machine.

Cleaning the Platen Glass and Document Cover

▶▶ Important

- Be sure to turn off the power and unplug the power cord before cleaning the machine.
- Do not use tissue paper, paper towels, rough-textured cloth, or similar materials for cleaning so as not to scratch the surface. Paper tissue powder or fine threads may remain inside the machine and cause problems such as print head blockage and poor printing results.
- Never use volatile liquids such as thinners, benzene, acetone, or any other chemical cleaner to clean the machine, as this may cause a malfunction or damage the surface of the machine.

Use a soft, clean, lint-free and dry cloth. Wipe the platen glass (A) and the inner side of the document cover (white sheet) (B) gently. Make sure not to leave any residue, especially on the glass surface.



▶▶ Important

- The inner side of the document cover (white sheet) (B) is easily damaged, so wipe it gently.

Cleaning the Paper Feed Roller

If the paper feed roller is dirty or paper powder is attached to it, paper may not be fed properly.

In this case, clean the paper feed roller. Cleaning will wear out the paper feed roller, so perform this only when necessary.

You need to prepare: three sheets of A4 or Letter-sized plain paper

1. Make sure that the power is turned on and remove any paper from the rear tray.
2. Hold down the **Stop** button until the **Alarm** lamp flashes eleven times, then release it immediately.

The paper feed roller will rotate as it is cleaned without paper.

3. Make sure that the paper feed roller has stopped rotating, then load three sheets of A4 or Letter-sized plain paper in the rear tray.
4. Pull out the paper output tray, then open the output tray extension.
5. Hold down the **Stop** button until the **Alarm** lamp flashes eleven times, then release it immediately.

The machine starts cleaning. The cleaning will be complete when the paper is ejected.

If the problem is not resolved after cleaning the paper feed roller, contact the service center.

Cleaning the Inside of the Machine (Bottom Plate Cleaning)

Remove stains from the inside of the machine. If the inside of the machine becomes dirty, printed paper may get dirty, so we recommend performing cleaning regularly.

You need to prepare: a single sheet of A4 or Letter-sized plain paper*

* Be sure to use a new piece of paper.

1. Make sure that the power is turned on and remove any paper from the rear tray.
2. Fold a single sheet of A4 or Letter-sized plain paper in half widthwise, then unfold the paper.
3. Load only this sheet of paper in the rear tray with the open side facing you.



4. Pull out the paper output tray, then open the output tray extension.
5. Hold down the **Stop** button until the **Alarm** lamp flashes twelve times, then release it immediately.

The paper cleans the inside of the machine as it feeds through the machine.

Check the folded parts of the ejected paper. If they are smudged with ink, perform Bottom Plate Cleaning again.

▶▶▶ Note

- When performing Bottom Plate Cleaning again, be sure to use a new piece of paper.

If the problem is not resolved after performing cleaning again, the protrusions inside the machine may be stained. Wipe off any ink from the protrusions using a cotton swab or the like.

▶▶▶ Important

- Be sure to turn off the power and unplug the power cord before cleaning the machine.

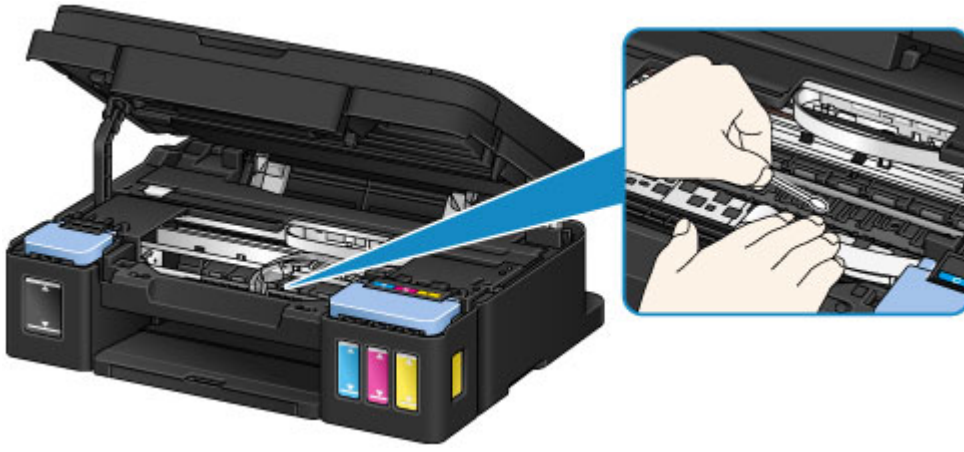

Overview

▶ **Safety**

- Safety Precautions
- Regulatory Information

▶ **Main Components and Their Use**

- Main Components
- Power Supply

▶ **Changing Settings**

- Changing Printer Settings from Your Computer (Windows)
- Changing Printer Settings from Your Computer (Mac OS)
- Changing Settings from Operation Panel
- Initializing Machine Settings

▶ **Ensuring Optimal Printing Results**

- Ink Tips
- Printing Tips
- Be Sure to Make Paper Settings after Loading Paper
- Canceling a Print Job
- Machine Handling Precautions
- Keeping Print Quality High
- Transporting Your Printer

▶ **Legal Restrictions on Scanning/Copying**

▶ **Specifications**

Safety

- ▶ **Safety Precautions**
- ▶ **Regulatory Information**

Safety Precautions

Choosing a location

- Do not install the printer in a location that is unstable or subject to excessive vibration.
- Do not install the printer in locations that are very humid or dusty, in direct sunlight, outdoors, or close to a heating source.
To avoid the risk of fire or electric shocks, use the printer under the operating environment specified in the Specification.
- Do not place the printer on a thick rug or carpet.
- Do not place the printer with its back attached to the wall.

Power supply

- Ensure that the area around the power outlet is kept clear at all times so you can easily unplug the power cord if necessary.
- Never remove the plug by pulling on the cord.
Pulling the cord may damage the power cord, leading to possible fire or electrical shock.
- Do not use an extension lead/cord.

Working around the printer

- Never put your hands or fingers in the printer while it is printing.
- When moving the printer, carry the printer at both ends. In case the printer weighs more than 14kg, it is recommended to have two people lifting the printer. Accidental dropping of the printer may cause injury. For the printer's weight, refer to the Specification.
- Do not place any object on the printer. Especially do not place metal objects (paper clips, staples, etc.) or containers of flammable solvents (alcohol, thinners, etc.) on top of the printer.
- Do not transport or use the printer on a slant, vertically or upside-down, as the ink may leak and damage the printer.
- When loading a thick book on the Platen Glass, do not press hard on the Document Cover. The Platen Glass may break and cause injury.

Print Heads/ink tanks and FINE Cartridges

- Keep ink tanks out of the reach of children. In case ink is accidentally licked or swallowed, rinse out mouth or give one or two glasses of water to drink. If irritation or discomfort occurs, obtain medical advice immediately.
- In case ink gets in contact with eyes, rinse with water immediately. In case ink gets in contact with skin, wash with soap and water immediately. If irritation to eyes or skin persists, obtain medical advice immediately.
- Never touch the electrical contacts on a Print Head or FINE Cartridges after printing.
The metal parts may be very hot and could cause burns.
- Do not throw ink tanks and FINE Cartridges into fire.
- Do not attempt to disassemble or modify the Print Head, ink tanks, and FINE Cartridges.

Regulatory Information

Users in the U.S.A.

FCC Notice (U.S.A. Only)
For 120V, 60Hz model
Model Number: K10431

This device complies with Part 15 of the FCC Rules. Operation is subject to the following two conditions: (1) This device may not cause harmful interference, and (2) this device must accept any interference received, including interference that may cause undesired operation.

Note: This equipment has been tested and found to comply with the limits for a Class B digital device, pursuant to Part 15 of the FCC Rules. These limits are designed to provide reasonable protection against harmful interference in a residential installation. This equipment generates, uses and can radiate radio frequency energy and, if not installed and used in accordance with the instructions, may cause harmful interference to radio communications.

However, there is no guarantee that interference will not occur in a particular installation. If this equipment does cause harmful interference to radio or television reception, which can be determined by turning the equipment off and on, the user is encouraged to try to correct the interference by one or more of the following measures:

- Reorient or relocate the receiving antenna.
- Increase the separation between the equipment and receiver.
- Connect the equipment into an outlet on a circuit different from that to which the receiver is connected.
- Consult the dealer or an experienced radio/TV technician for help.

Use of a shielded cable is required to comply with Class B limits in Subpart B of Part 15 of the FCC Rules.

Do not make any changes or modifications to the equipment unless otherwise specified in the manual. If such changes or modifications should be made, you could be required to stop operation of the equipment.

Canon U.S.A., Inc.
One Canon Park
Melville, New York 11747
1-800-652-2666

Only for European Union and EEA (Norway, Iceland and Liechtenstein)



This symbol indicates that this product is not to be disposed of with your household waste, according to the WEEE Directive (2012/19/EU) and national legislation. This product should be handed over to a designated collection point, e.g., on an authorized one-for-one basis when you buy a new similar product or to an authorized collection site for recycling waste electrical and electronic equipment (EEE). Improper handling of this type of waste could have a possible negative impact on the environment and human health due to potentially hazardous substances that are generally associated with EEE. At the same time, your cooperation in the correct disposal of this product will contribute to the effective usage of natural resources. For more information about where you can drop off your waste equipment for recycling, please

contact your local city office, waste authority, approved WEEE scheme or your household waste disposal service. For more information regarding return and recycling of WEEE products, please visit www.canon-europe.com/weee.

Nur für Europäische Union und EWR (Norwegen, Island und Liechtenstein)



Dieses Symbol weist darauf hin, dass dieses Produkt gemäß der EU-Richtlinie über Elektro- und Elektronik-Altgeräte (2012/19/EU) und nationalen Gesetzen nicht über den Hausmüll entsorgt werden darf. Dieses Produkt muss bei einer dafür vorgesehenen Sammelstelle abgegeben werden. Dies kann z. B. durch Rückgabe beim Kauf eines ähnlichen Produkts oder durch Abgabe bei einer autorisierten Sammelstelle für die Wiederaufbereitung von Elektro- und Elektronik-Altgeräten geschehen. Der unsachgemäße Umgang mit Altgeräten kann aufgrund potentiell gefährlicher Stoffe, die generell mit Elektro- und Elektronik-Altgeräten in Verbindung stehen, negative Auswirkungen auf die Umwelt und die menschliche Gesundheit haben. Durch die umweltgerechte Entsorgung dieses Produkts tragen Sie außerdem zu einer effektiven Nutzung natürlicher Ressourcen bei. Informationen zu Sammelstellen für Altgeräte erhalten Sie bei Ihrer Stadtverwaltung, dem öffentlich-rechtlichen Entsorgungsträger, einer autorisierten Stelle für die Entsorgung von Elektro- und Elektronik-Altgeräten oder Ihrem örtlichen Entsorgungsunternehmen. Weitere Informationen zur Rückgabe und Entsorgung von Elektro- und Elektronik-Altgeräten finden Sie unter www.canon-europe.com/weee.

Union Européenne, Norvège, Islande et Liechtenstein uniquement.



Ce symbole indique que ce produit ne doit pas être jeté avec les ordures ménagères, conformément à la directive DEEE (2012/19/UE) et à la réglementation de votre pays. Ce produit doit être confié au distributeur à chaque fois que vous achetez un produit neuf similaire, ou à un point de collecte mis en place par les collectivités locales pour le recyclage des Déchets des Équipements Électriques et Électroniques (DEEE). Le traitement inapproprié de ce type de déchet risque d'avoir des répercussions sur l'environnement et la santé humaine, du fait de la présence de substances potentiellement dangereuses généralement associées aux équipements électriques et électroniques. Parallèlement, votre entière coopération dans le cadre de la mise au rebut correcte de ce produit favorisera une meilleure utilisation des ressources naturelles. Pour plus d'informations sur les points de collecte des équipements à recycler, contactez vos services municipaux, les autorités locales compétentes, le plan DEEE approuvé ou le service d'enlèvement des ordures ménagères. Pour plus d'informations sur le retour et le recyclage des produits DEEE, consultez le site: www.canon-europe.com/weee.

Uitsluitend bestemd voor de Europese Unie en EER (Noorwegen, IJsland en Liechtenstein)



Dit symbool geeft aan dat dit product in overeenstemming met de AEEA-richtlijn (2012/19/EU) en de nationale wetgeving niet mag worden afgevoerd met het huishoudelijk afval. Dit product moet worden ingeleverd bij een aangewezen, geautoriseerd inzamelpunt, bijvoorbeeld wanneer u een nieuw gelijksoortig product aanschaft, of bij een geautoriseerd inzamelpunt voor hergebruik van elektrische en elektronische apparatuur (EEA). Een onjuiste afvoer van dit type afval kan leiden tot negatieve effecten op het milieu en de volksgezondheid als gevolg van potentieel gevaarlijke stoffen die veel voorkomen in elektrische en elektronische apparatuur (EEA). Bovendien werkt u door een juiste afvoer van dit product mee aan het effectieve gebruik van natuurlijke hulpbronnen. Voor meer informatie over waar u uw afgedankte apparatuur kunt inleveren voor recycling kunt u contact opnemen met het gemeentehuis in uw woonplaats, de reinigingsdienst, of het afvalverwerkingsbedrijf. U kunt ook het schema voor de afvoer van afgedankte elektrische en elektronische apparatuur (AEEA) raadplegen. Ga voor meer informatie over het inzamelen en recyclen van afgedankte elektrische en elektronische apparatuur naar www.canon-europe.com/weee.

Sólo para la Unión Europea y el Área Económica Europea (Noruega, Islandia y Liechtenstein)



Este símbolo indica que este producto no debe desecharse con los desperdicios domésticos, de acuerdo con la directiva RAEE (2012/19/UE) y con la legislación nacional. Este producto debe entregarse en uno de los puntos de recogida designados, como por ejemplo, entregándolo en el lugar de venta al comprar un producto similar o depositándolo en un lugar de recogida autorizado para el reciclado de residuos de aparatos eléctricos y electrónicos (RAEE). La manipulación inapropiada de este tipo de desechos podría tener un impacto negativo en el entorno y la salud humana, debido a las sustancias potencialmente peligrosas que normalmente están asociadas con los RAEE. Al mismo tiempo, su cooperación a la hora de desechar correctamente este producto contribuirá a la utilización eficaz de los recursos naturales. Para más información sobre cómo puede eliminar el equipo para su reciclado, póngase en contacto con las autoridades locales, con las autoridades encargadas de los desechos, con un sistema de gestión RAEE autorizado o con el servicio de recogida de basuras doméstico. Si desea más información acerca de la devolución y reciclado de RAEE, visite la web www.canon-europe.com/weee.

Només per a la Unió Europea i a l'Espai Econòmic Europeu (Noruega, Islàndia i Liechtenstein)



Aquest símbol indica que aquest producte no s'ha de llençar a les escombraries de la llar, d'acord amb la Directiva RAEE (2012/19/UE) i la legislació nacional. Aquest producte s'hauria de lliurar en un dels punts de recollida designats, com per exemple, intercanviant-lo un per un en comprar un producte similar o lliurant-lo en un lloc de recollida autoritzat per al reciclatge de residus d'aparells elèctrics i electrònics (AEE). La manipulació inadequada d'aquest tipus de residus podria tenir un impacte negatiu en l'entorn i en la salut humana, a causa de les substàncies potencialment perilloses que normalment estan associades als AEE. Així mateix, la vostra cooperació a l'hora de llençar correctament aquest producte contribuirà a la utilització efectiva dels recursos naturals. Per a més informació sobre els punts on podeu lliurar aquest producte per procedir al seu reciclatge, adreceu-vos a la vostra oficina municipal, a les autoritats encarregades dels residus, al pla de residus homologat per la RAEE o al servei de recollida de deixalles domèstiques de la vostra localitat. Per a més informació sobre la devolució i el reciclatge de productes RAEE, visiteu www.canon-europe.com/weee.

Solo per Unione Europea e SEE (Norvegia, Islanda e Liechtenstein)



Questo simbolo indica che il prodotto deve essere oggetto di raccolta separata in conformità alla Direttiva RAEE (2012/19/UE) e alla normativa locale vigente. Il prodotto deve essere smaltito presso un centro di raccolta differenziata, un distributore autorizzato che applichi il principio dell'"uno contro uno", ovvero del ritiro della vecchia apparecchiatura elettrica al momento dell'acquisto di una nuova, o un impianto autorizzato al riciclaggio dei rifiuti di apparecchiature elettriche ed elettroniche. La gestione impropria di questo tipo di rifiuti può avere un impatto negativo sull'ambiente e sulla salute umana causato dalle sostanze potenzialmente pericolose che potrebbero essere contenute nelle apparecchiature elettriche ed elettroniche. Un corretto smaltimento di tali prodotti contribuirà inoltre a un uso efficace delle risorse naturali ed eviterà di incorrere nelle sanzioni amministrative di cui all'art. 255 e successivi del Decreto Legislativo n. 152/06. Per ulteriori informazioni sullo smaltimento e il recupero dei Rifiuti di Apparecchiature Elettriche ed Elettroniche, consultare la Direttiva RAEE, rivolgersi alle autorità competenti, oppure visitare il sito www.canon-europe.com/weee.

Apenas para a União Europeia e AEE (Noruega, Islândia e Liechtenstein)



Este símbolo indica que o produto não deve ser colocado no lixo doméstico, de acordo com a Directiva REEE (2012/19/UE) e a legislação nacional. Este produto deverá ser colocado num ponto de recolha designado, por exemplo, num local próprio autorizado quando adquirir um produto semelhante novo ou num local de recolha autorizado para reciclar resíduos de equipamentos eléctricos e electrónicos (EEE). O tratamento inadequado deste tipo de resíduo poderá causar um impacto negativo no ambiente e na saúde humana devido às substâncias potencialmente perigosas normalmente associadas aos equipamentos eléctricos e electrónicos. Simultaneamente, a sua cooperação no tratamento correcto deste produto contribuirá para a utilização eficaz dos recursos naturais. Para mais informações sobre os locais onde o equipamento poderá ser reciclado, contacte os serviços locais, a autoridade responsável

pelos resíduos, o esquema REEE aprovado ou o serviço de tratamento de lixo doméstico. Para mais informações sobre a devolução e reciclagem de produtos REEE, vá a www.canon-europe.com/weee.

Gælder kun i Europæiske Union og EØS (Norge, Island og Liechtenstein)



Dette symbol angiver, at det pågældende produkt ikke må bortskaffes sammen med dagrenovation jf. direktivet om affald af elektrisk og elektronisk udstyr (WEEE) (2012/19/EU) og gældende national lovgivning. Det pågældende produkt skal afleveres på et nærmere specificeret indsamlingssted, f.eks. i overensstemmelse med en godkendt én-til-én-procedure, når du indkøber et nyt tilsvarende produkt, eller produktet skal afleveres på et godkendt indsamlingssted for elektronikaffald. Forkert håndtering af denne type affald kan medføre negative konsekvenser for miljøet og menneskers helbred på grund af de potentielt sundhedsskadelige stoffer, der generelt kan forefindes i elektrisk og elektronisk udstyr. Når du foretager korrekt bortskaffelse af det pågældende produkt, bidrager du til effektiv brug af naturressourcerne. Yderligere oplysninger om, hvor du kan bortskaffe dit elektronikaffald med henblik på genanvendelse, får du hos de kommunale renovationsmyndigheder. Yderligere oplysninger om returnering og genanvendelse af affald af elektrisk og elektronisk udstyr får du ved at besøge www.canon-europe.com/weee.

Μόνο για την Ευρωπαϊκή Ένωση και τον ΕΟΧ (Νορβηγία, Ισλανδία και Λιχτενστάιν)



Αυτό το σύμβολο υποδηλώνει ότι αυτό το προϊόν δεν πρέπει να απορρίπτεται μαζί με τα οικιακά απορρίμματα, σύμφωνα με την Οδηγία σχετικά με τα Απόβλητα Ηλεκτρικού και Ηλεκτρονικού Εξοπλισμού (ΑΗΗΕ) (2012/19/ΕΕ) και την εθνική σας νομοθεσία. Αυτό το προϊόν πρέπει να παραδίδεται σε καθορισμένο σημείο συλλογής, π.χ. σε μια εξουσιοδοτημένη βάση ανταλλαγής όταν αγοράζετε ένα νέο παρόμοιο προϊόν ή σε μια εξουσιοδοτημένη θέση συλλογής για την ανακύκλωση των αποβλήτων Ηλεκτρικού και Ηλεκτρονικού Εξοπλισμού (ΗΗΕ). Ο ακατάλληλος χειρισμός αυτού του τύπου αποβλήτων μπορεί να έχει αρνητικό αντίκτυπο στο περιβάλλον και την υγεία του ανθρώπου, λόγω δυνητικώς επικίνδυνων ουσιών που γενικά συνδέονται με τον ΗΗΕ. Ταυτόχρονα, η συνεργασία σας όσον αφορά τη σωστή απόρριψη αυτού του προϊόντος θα συμβάλει στην αποτελεσματική χρήση των φυσικών πόρων. Για περισσότερες πληροφορίες σχετικά με τα σημεία όπου μπορείτε να απορρίψετε τον εξοπλισμό σας για ανακύκλωση, επικοινωνήστε με το τοπικό γραφείο της πόλης σας, την υπηρεσία απορριμμάτων, το εγκεκριμένο σχήμα ΑΗΗΕ ή την υπηρεσία απόρριψης οικιακών αποβλήτων. Για περισσότερες πληροφορίες σχετικά με την επιστροφή και την ανακύκλωση των προϊόντων ΑΗΗΕ, επισκεφθείτε την τοποθεσία www.canon-europe.com/weee.

Gjelder kun den europeiske union og EØS (Norge, Island og Liechtenstein)



Dette symbolet indikerer at dette produktet ikke skal kastes sammen med husholdningsavfall, i henhold til WEEE-direktiv (2012/19/EU) og nasjonal lov. Produktet må leveres til et dertil egnet innsamlingspunkt, det vil si på en autorisert en-til-en-basis når du kjøper et nytt lignende produkt, eller til et autorisert innsamlingssted for resirkulering av avfall fra elektrisk og elektronisk utstyr (EE-utstyr). Feil håndtering av denne typen avfall kan være miljø- og helseskadelig på grunn av potensielt skadelige stoffer som ofte brukes i EE-utstyr. Samtidig bidrar din innsats for korrekt avhending av produktet til effektiv bruk av naturressurser. Du kan få mer informasjon om hvor du kan avhende utrangert utstyr til resirkulering ved å kontakte lokale myndigheter, et godkjent WEEE-program eller husholdningens renovasjonsselskap. Du finner mer informasjon om retur og resirkulering av WEEE-produkter på www.canon-europe.com/weee.

Vain Euroopan unionin sekä ETA:n (Norja, Islanti ja Liechtenstein) alueelle.



Tämä tunnus osoittaa, että sähkö- ja elektroniikkalaiteromua koskeva direktiivi (SER-direktiivi, 2012/19/EU) sekä kansallinen lainsäädäntö kieltävät tuotteen hävittämisen talousjätteen mukana. Tuote on vietävä asianmukaiseen keräyspisteeseen, esimerkiksi kodinkoneliikkeeseen uutta vastaavaa tuotetta ostettaessa tai viralliseen sähkö- ja elektroniikkalaiteromun keräyspisteeseen. Sähkö- ja elektroniikkalaiteromun virheellinen käsittely voi vahingoittaa ympäristöä ja ihmisten terveyttä, koska laitteet saattavat sisältää ympäristölle ja terveydelle haitallisia aineita. Lisäksi tuotteen asianmukainen hävittäminen säästää luonnonvaroja. Lisätietoja sähkö- ja elektroniikkalaiteromun keräyspisteistä saat kaupunkien ja kuntien tiedotuksesta, jätehuoltoviranomaisilta, sähkö- ja elektroniikkalaiteromun kierrätysjärjestelmän ylläpitäjältä ja jätehuoltoyhtiöltä. Lisätietoja sähkö- ja elektroniikkalaiteromun keräyksestä ja kierrätyksestä on osoitteessa www.canon-europe.com/weee.

Endast för Europeiska unionen och EES (Norge, Island och Liechtenstein)



Den här symbolen visar att produkten enligt WEEE-direktivet (2012/19/EU) och nationell lagstiftning inte får sorteras och slängas som hushållsavfall. Den här produkten ska lämnas in på en därför avsedd insamlingsplats, t.ex. på en återvinningsstation auktoriserad att hantera elektrisk och elektronisk utrustning (EE-utrustning) eller hos handlare som är auktoriserade att byta in varor då nya, motsvarande köps (en mot en). Olämplig hantering av avfall av den här typen kan ha en negativ inverkan på miljön och människors hälsa på grund av de potentiellt farliga ämnen som kan återfinnas i elektrisk och elektronisk utrustning. Din medverkan till en korrekt avfallshantering av den här produkten bidrar dessutom till en effektiv användning av naturresurserna. Kontakta ditt lokala kommunkontor, berörd myndighet, företag för avfallshantering eller ta del av en godkänd WEEE-organisation om du vill ha mer information om var du

kan lämna den kasserade produkten för återvinning. För mer information om inlämning och återvinning av WEEE-produkter, se www.canon-europe.com/weee.

Pouze Evropská unie a EHP (Norsko, Island a Lichtenštejsko)



Tento symbol znamená, že podle směrnice o OEEZ (2012/19/EU) a podle vnitrostátních právních předpisů nemá být tento výrobek likvidován s odpadem z domácností. Tento výrobek má být vrácen do sběrného místa, např. v rámci autorizovaného systému odběru jednoho výrobku za jeden nově prodaný podobný výrobek nebo v autorizovaném sběrném místě pro recyklaci odpadních elektrických a elektronických zařízení (OEEZ). Nevhodné nakládání s tímto druhem odpadu by mohlo mít negativní dopad na životní prostředí a lidské zdraví, protože elektrická a elektronická zařízení zpravidla obsahují potenciálně nebezpečné látky. Vaše spolupráce na správné likvidaci tohoto výrobku současně napomůže efektivnímu využívání přírodních zdrojů. Další informace o místech sběru vašeho odpadního zařízení k recyklaci vám sdělí místní úřad vaší obce, správní orgán vykonávající dozor nad likvidací odpadu, sběrný OEEZ nebo služba pro odvoz komunálního odpadu. Další informace týkající se vracení a recyklace OEEZ naleznete na adrese www.canon-europe.com/weee.

Csak az Európai Unió és az EGT (Norvégia, Izland és Liechtenstein) országaiiban



Ez a szimbólum azt jelzi, hogy a helyi törvények és a WEEE-irányelv (2012/19/EU) szerint a termék nem kezelhető háztartási hulladékként. A terméket a kijelölt nyilvános gyűjtőpontokon kell leadni, például hasonló cserekészülék vásárlásakor, illetve bármelyik, elektromos és elektronikai berendezésekből származó hulladék (WEEE) átvételére feljogosított gyűjtőponton. Az ilyen jellegű hulladékok a nem megfelelő kezelés esetén a bennük található veszélyes anyagok révén ártalmasak lehetnek a környezetre és az emberek egészségére. Továbbá, a termékből származó hulladék megfelelő kezelésével hozzájárulhat a természetes nyersanyagok hatékonyabb hasznosításához. A berendezésekből származó, újrahasznosítható hulladékok elhelyezésére vonatkozó további tudnivalókért forduljon a helyi önkormányzathoz, a közterület-fenntartó vállalathoz, a háztartási hulladék begyűjtését végző vállalathoz, illetve a hivatalos WEEE-képviselőhöz. További tudnivalókat a WEEE-termékek visszajuttatásáról és újrahasznosításáról a www.canon-europe.com/weee.

Tylko dla krajów Unii Europejskiej oraz EOG (Norwegia, Islandia i Liechtenstein)



Ten symbol oznacza, że zgodnie z dyrektywą WEEE dotyczącą zużytego sprzętu elektrycznego i elektronicznego (2012/19/UE) oraz przepisami lokalnymi nie należy wyrzucać tego produktu razem z odpadami gospodarstwa domowego. Produkt należy przekazać do wyznaczonego punktu gromadzenia odpadów, np. firmie, od której kupowany jest nowy, podobny produkt lub do autoryzowanego punktu gromadzenia zużytego sprzętu elektrycznego i elektronicznego w celu poddania go recyklingowi. Usuwanie tego typu odpadów w nieodpowiedni sposób może mieć negatywny wpływ na otoczenie i zdrowie innych osób ze względu na niebezpieczne substancje stosowane w takim sprzęcie. Jednocześnie pozbycie się zużytego sprzętu w zalecany sposób przyczynia się do właściwego wykorzystania zasobów naturalnych. Aby uzyskać więcej informacji na temat punktów, do których można dostarczyć sprzęt do recyklingu, prosimy skontaktować się z lokalnym urzędem miasta, zakładem utylizacji odpadów, skorzystać z instrukcji zatwierdzonej dyrektywą WEEE lub skontaktować się z przedsiębiorstwem zajmującym się wywozem odpadów domowych. Więcej informacji o zwracaniu i recyklingu zużytego sprzętu elektrycznego i elektronicznego znajduje się w witrynie www.canon-europe.com/weee.

Platí len pre štáty Európskej únie a EHP (Nórsko, Island a Lichtenštajnsko)



Tento symbol znamená, že podľa Smernice 2012/19/EÚ o odpade z elektrických a elektronických zariadení (OEEZ) a podľa platnej legislatívy Slovenskej republiky sa tento produkt nesmie likvidovať spolu s komunálnym odpadom. Produkt je potrebné odovzdať do určenej zberne, napr. prostredníctvom výmeny za kúpu nového podobného produktu, alebo na autorizované zberné miesto, ktoré spracúva odpad z elektrických a elektronických zariadení (EEZ). Nesprávna manipulácia s takýmto typom odpadu môže mať negatívny vplyv na životné prostredie a ľudské zdravie, pretože elektrické a elektronické zariadenia obsahujú potenciálne nebezpečné látky. Spoluprácou na správnej likvidácii produktu prispějete k účinnému využívaniu prírodných zdrojov. Ďalšie informácie o mieste recyklácie opotrebovaných zariadení získate od miestneho úradu, úradu životného prostredia, zo schváleného plánu OEEZ alebo od spoločnosti, ktorá zaisťuje likvidáciu komunálneho odpadu. Viac informácií nájdete aj na webovej stránke: www.canon-europe.com/weee.

Üksnes Euroopa Liit ja EMP (Norra, Island ja Liechtenstein)



See sümbol näitab, et antud toodet ei tohi vastavalt elektri- ja elektroonikaseadmete jäätmeid käsitlevale direktiivile (2012/19/EL) ning teie riigis kehtivatele õigusaktidele utiliseerida koos olmejäätmetega. Antud toode tuleb anda selleks määratud kogumispunkti, nt müügipunkt, mis on volitatud üks ühe vastu vahetama, kui ostate uue sarnase toote, või elektri- ja elektroonikaseadmete jäätmete ümbertöötlemiseks mõeldud kogumispunkti. Täiendava teabe saamiseks elektri- ja elektroonikaseadmetest tekkinud jäätmete tagastamise ja ümbertöötlemise kohta võtke ühendust kohaliku omavalitsusega, asjakohase valitsusasutusega, asjakohase tootjavastutusorganisatsiooniga või olmejäätmete käitlejaga. Lisateavet leitate ka Interneti-leheküljelt www.canon-europe.com/weee.

Tikai Eiropas Savienībai un EEZ (Norvēģijai, Islandei un Lihtenšteinai)



Šis simbols norāda, ka atbilstoši ES Direktīvai (2012/19/ES) par elektrisko un elektronisko iekārtu atkritumiem (EEIA) un vietējiem tiesību aktiem no šī izstrādājuma nedrīkst atbrīvoties, izmetot to kopā ar sadzīves atkritumiem. Šis izstrādājums ir jānodod piemērotā savākšanas vietā, piemēram, apstiprinātā veikalā, kur iegādājaties līdzīgu jaunu produktu un atstājat veco, vai apstiprinātā vietā izlietotu elektrisko un elektronisko iekārtu pārstrādei. Nepareiza šāda veida atkritumu apsaimniekošana var apdraudēt vidi un cilvēka veselību tādu iespējami bīstamu vielu dēļ, kas parasti ir elektriskajās un elektroniskajās iekārtās. Turklāt jūsu atbalsts pareizā šāda veida atkritumu apsaimniekošanā sekmēs efektīvu dabas resursu izmantošanu. Lai saņemtu pilnīgāku informāciju par vietām, kur izlietoto iekārtu var nodot pārstrādei, sazinieties ar vietējo pašvaldību, atkritumu savākšanas atbildīgo dienestu, pilnvarotu EEIA struktūru vai sadzīves atkritumu apsaimniekošanas iestādi. Lai saņemtu plašāku informāciju par elektrisko un elektronisko iekārtu nodošanu pārstrādei, apmeklējiet tīmekļa vietni www.canon-europe.com/weee.

Tik Europos Sąjungai ir EEE (Norvegijai, Islandijai ir Lichtenšteinai)



Šis ženkla reiškia, kad gaminio negalima išmesti su buitinėmis atliekomis, kaip yra nustatyta Direktyvoje (2012/19/ES) ir nacionaliniuose teisė aktuose dėl EEJ atliekų tvarkymo. Šį gaminį reikia atiduoti į tam skirtą surinkimo punktą, pvz., pagal patvirtintą keitimo sistemą, kai perkamas panašus gaminy, arba į elektros ir elektroninės įrangos (EEJ) atliekų perdirbimo punktą. Netinkamas tokios rūšies atliekų tvarkymas dėl elektros ir elektroninės įrangoje esančių pavojingų medžiagų gali pakenkti aplinkai ir žmonių sveikatai. Padėdami užtikrinti tinkamą šio gaminio šalinimo tvarką, kartu prisidėsite prie veiksmingo gamtos išteklių naudojimo. Jei reikia daugiau informacijos, kaip šalinti tokias atliekas, kad jos būtų toliau perdirbamos, kreipkitės į savo miesto valdžios institucijas, atliekų tvarkymo organizacijas, patvirtintų EEJ atliekų sistemų arba jūsų buitinių atliekų tvarkymo įstaigų atstovus. Išsamesnės informacijos apie EEJ atliekų grąžinimo ir perdirbimo tvarką galite rasti apsilankę tinklalapyje www.canon-europe.com/weee.

Samo za Evropsko unijo in EGP (Norveška, Islandija in Lihtenštajn)



Ta simbol pomeni, da tega izdelka v skladu z direktivo OEEO (2012/19/EU) in državno zakonodajo ne smete odvreči v gospodinjske odpadke. Ta izdelek morate odložiti na ustrezno zbiralno mesto, na primer pri pooblaščenem prodajalcu, ko kupite podoben nov izdelek ali na zbiralno mesto za recikliranje električne in elektronske opreme. Neprimerno ravnanje s takšnimi odpadki lahko negativno vpliva na okolje in človekovo zdravje zaradi nevarnih snovi, ki so povezane z električno in elektronsko opremo. S pravilno odstranitvijo izdelka hkrati prispevate tudi k učinkoviti porabi naravnih virov. Če želite več informacij o tem, kje lahko odložite odpadno opremo za recikliranje, pokličite občinski urad, komunalno

podjetje ali službo, ki skrbi za odstranjevanje odpadkov, ali si oglejte načrt OEEО. Če želite več informacij o vračanju in recikliranju izdelkov v skladu z direktivo OEEО, obiščite www.canon-europe.com/weee.

Само за Европейския съюз и ЕИП (Норвегия, Исландия и Лихтенщайн)



Този символ показва, че този продукт не трябва да се изхвърля заедно с битовите отпадъци, съгласно Директивата за ИУЕЕО (2012/19/ЕС) и Вашето национално законодателство. Този продукт трябва да бъде предаден в предназначен за целта пункт за събиране, например на база размяна, когато купувате нов подобен продукт, или в одобрен събирателен пункт за рециклиране на излязло от употреба електрическо и електронно оборудване (ИУЕЕО). Неправилното третиране на този тип отпадъци може да доведе до евентуални отрицателни последици за околната среда и човешкото здраве поради потенциално опасните вещества, които обикновено са свързани с ЕЕО. В същото време Вашето съдействие за правилното изхвърляне на този продукт ще допринесе за ефективното използване на природните ресурси. Повече информация относно местата, където може да предавате излязло от употреба оборудване за рециклиране, може да получите от местните власти, от органа, отговорен за отпадъците и от одобрена система за излязло от употреба ЕЕО или от Вашата местна служба за битови отпадъци. За повече информация относно връщането и рециклирането на продукти от излязло от употреба ЕЕО посетете www.canon-europe.com/weee.

Doar pentru Uniunea Europeană și EEA (Norvegia, Islanda și Liechtenstein)



Acest simbol indică faptul că acest produs nu trebuie aruncat o dată cu reziduurile menajere, în conformitate cu Directiva DEEE (Directiva privind deșeurile de echipamente electrice și electronice) (2012/19/UE) și legile naționale. Acest produs trebuie transportat la un punct de colectare special, de exemplu un centru care preia produsele vechi atunci când achiziționați un produs nou similar, sau la un punct de colectare autorizat pentru reciclarea deșeurilor provenite de la echipamentele electrice și electronice (EEE). Mănuirea necorespunzătoare a acestor tipuri de deșeuri poate avea un impact negativ asupra mediului înconjurător și sănătății indivizilor, din cauza substanțelor potențial nocive care sunt în general asociate cu EEE. În același timp, cooperarea dvs. la reciclarea corectă a acestui produs va contribui la utilizarea efectivă a resurselor naturale. Pentru mai multe informații privind locurile de reciclare a deșeurilor provenite de la echipamente, contactați biroul primăriei locale, autoritatea responsabilă cu colectarea deșeurilor, schema DEEE aprobată sau serviciul de colectare a deșeurilor menajere. Pentru mai multe informații privind returnarea și reciclarea produselor DEEE, vizitați www.canon-europe.com/weee.

Samo za Europsku uniju i EEZ (Norveška, Island i Lihtenštajn)



Ovaj simbol pokazuje da se ovaj proizvod ne smije odlagati s kućnim otpadom sukladno WEEE Direktivi (2012/19/EC) i vašem nacionalnom zakonu. Ovaj proizvod je potrebno predati na posebno mjesto za sakupljanje otpada, npr. na ovlašteno mjesto gdje možete zamijeniti staro za novo ukoliko kupujete novi sličan proizvod ili na ovlašteno mjesto za sakupljanje rabljene električne i elektroničke opreme (EEE) za recikliranje. Nepropisno rukovanje ovom vrstom otpada može imati negativan učinak na okolinu i zdravlje ljudi zbog supstanci koje su potencijalno opasne za zdravlje, a općenito se povezuju s EEE. Istovremeno, vaša će suradnja kroz propisno odlaganje ovog proizvoda doprinijeti efektivnoj uporabi prirodnih resursa. Za više informacija o tome gdje možete odložiti svoj otpad za recikliranje obratite se vašem lokalnom gradskom uredu, komunalnoj službi, odobrenom WEEE programu ili službi za odlaganje kućnog otpada. Ostale informacije o vraćanju i recikliranju WEEE proizvoda potražite na www.canon-europe.com/weee.

Korisnici u Srbiji



Ovaj simbol označava da ovaj proizvod ne sme da se odlaže sa ostalim kućnim otpadom, u skladu sa WEEE Direktivom (2012/19/EU) i nacionalnim zakonima. Ovaj proizvod treba predati određenom centru za prikupljanje, npr. na osnovi "jedan-za-jedan" kada kupujete sličan novi proizvod, ili ovlašćenom centru za prikupljanje za reciklažu istrošene električne i elektronske opreme (EEE). Nepravilno rukovanje ovom vrstom otpada može da ima moguće negativne posledice po životnu sredinu i ljudsko zdravlje usled potencijalno opasnih materijala koji se uglavnom vezuju za EEE. U isto vreme, vaša saradnja na ispravnom odlaganju ovog proizvoda će doprineti efikasnom korišćenju prirodnih resursa. Za više informacija o tome gde možete da predate vašu staru opremu radi recikliranja, vas molimo, da kontaktirate lokalne gradske vlasti, komunalne službe, odobreni plan reciklaže ili Gradsku čistoću. Za više informacija o vraćanju i recikliranju WEEE proizvoda, posetite stranicu www.canon-europe.com/weee.

Environmental Information

Reducing your environmental impact

Power Consumption and Operational Modes

The amount of electricity a device consumes depends on the way the device is used. This product is designed and set in a way to allow you to reduce the power consumption. After the last print it switches to Ready Mode. In this mode it can print again immediately if required. If the product is not used for a time, the device switches to its Sleep Mode. The devices consume less power (Watt) in these modes.

Energy Star®

The Energy Star® programme is a voluntary scheme to promote the development and purchase of energy efficient models, which help to minimise environmental impact.

Products which meet the stringent requirements of the Energy Star® programme for both environmental benefits and the amount of energy consumption will carry the Energy Star® logo accordingly.

Paper types

This product can be used to print on both recycled and virgin paper (certified to an environmental stewardship scheme), which complies with EN12281 or a similar quality standard. In addition it can support printing on media down to a weight of 64g/m², lighter paper means less resources used and a lower environmental footprint for your printing needs.



Main Components and Their Use

- ▶ **Main Components**
- ▶ **Power Supply**

Main Components

- ▶ **Front View**
- ▶ **Rear View**
- ▶ **Inside View**
- ▶ **Operation Panel**

Front View

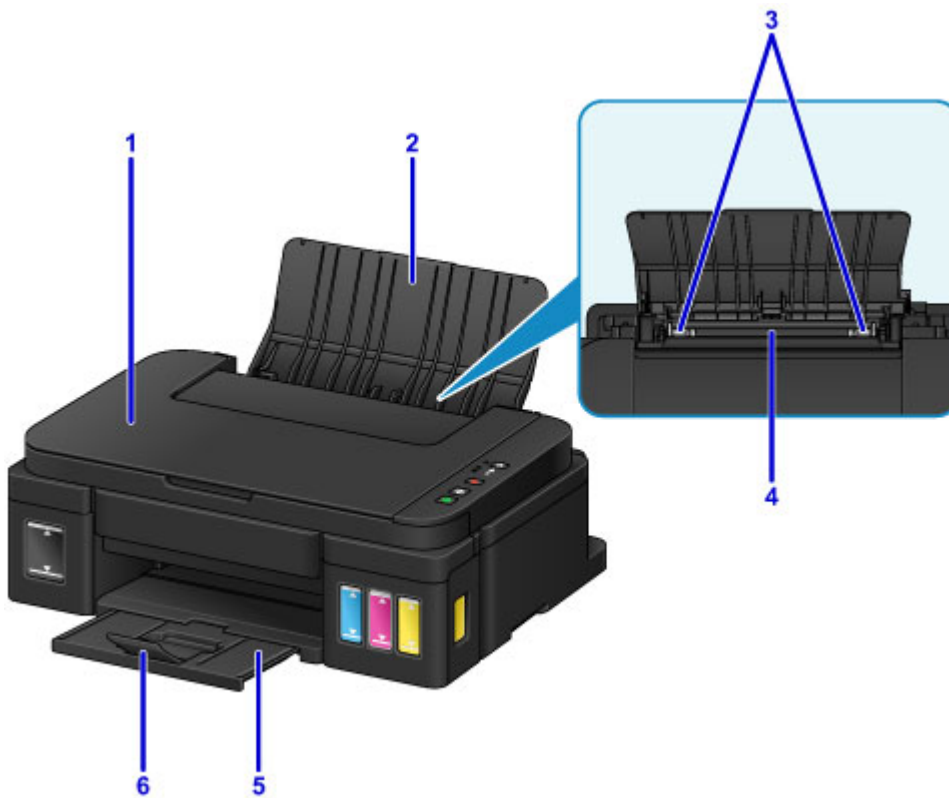

(1) document cover

Open to load an original on the platen glass.

(2) paper support

Open to load paper in the rear tray.

(3) paper guides

Align with both sides of the paper stack.

(4) rear tray

Load paper here. Two or more sheets of the same size and type of paper can be loaded at the same time, and fed automatically one sheet at a time.

■ [Loading Plain Paper / Photo Paper](#)

■ [Loading Envelopes](#)

(5) paper output tray

Printed paper is ejected. Open before printing.

(6) output tray extension

Open to support ejected paper.



(7) platen glass

Load an original here.

(8) operation panel

Use to change the settings of the machine or to operate it.

■ [Operation Panel](#)

Rear View

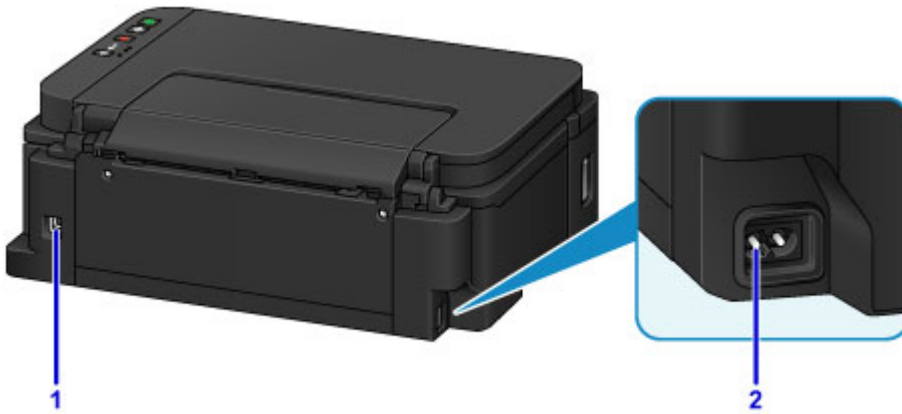

(1) USB port

Plug in the USB cable to connect the machine with a computer.

▶▶▶ Important

- Do not touch the metal casing.
- Do not plug in or unplug the USB cable while the machine is printing or scanning originals with the computer.

(2) power cord connector

Plug in the supplied power cord.

Inside View

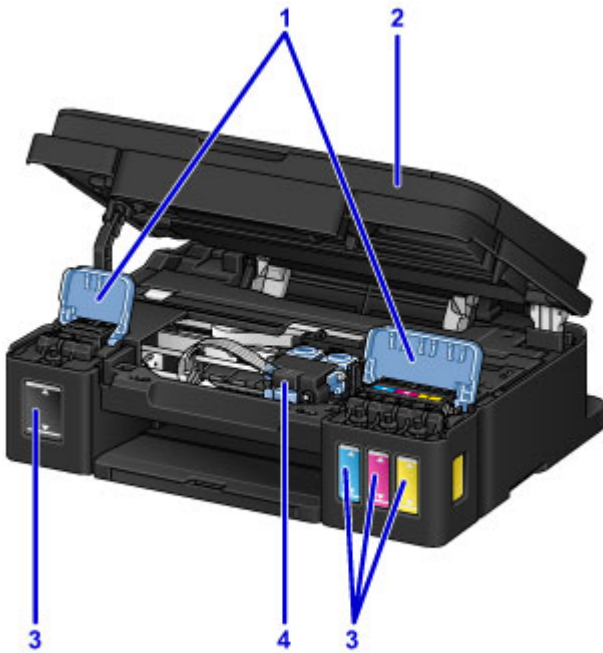

(1) ink tank covers

Open to refill ink tanks.

(2) scanning unit / cover

Scans originals. Open to refill ink tanks or to remove jammed paper.

(3) ink tanks

The black ink tank is on the right, and the color ink tanks (cyan, magenta, and yellow) are on the left.

If any ink levels are low, refill the low tanks.

(4) cartridge holder

Install the cartridge here.

▶▶▶ Note

- For details on refilling ink tanks, see [Refilling Ink Tanks](#).

Operation Panel

* All lamps on the operation panel are shown lit in the figure below for explanatory purposes.

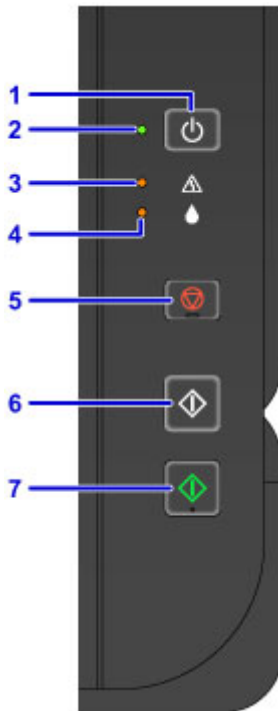

(1) ON button

Turns the power on or off.

■ [Turning the Machine On and Off](#)

(2) ON lamp

Lights after flashing when the power is turned on.

▶▶ Note

- You can check the status of the machine by the **ON** and **Alarm** lamps.
 - **ON** lamp is off: The power is off.
 - **ON** lamp lights: The machine is ready to print.
 - **ON** lamp flashes: The machine is getting ready to print, or printing is in progress.
 - **Alarm** lamp flashes: An error has occurred and the machine is not ready to print.
 - **ON** lamp flashes and **Alarm** lamp flashes alternately: An error that requires contacting the service center may have occurred.

■ [An Error Occurs](#)

(3) Alarm lamp

Lights or flashes when an error occurs. When performing machine maintenance or machine settings, options can be selected according to the number of flashes.

(4) Ink lamp

Lights or flashes when black or color ink runs out.

(5) Stop button

Cancels operation when print, copy, or scan job is in progress.

Holding this button down lets you select maintenance options or machine settings.

(6) Black button*

Starts black & white copying. You can also press this button to finalize your selection for the setting item.

(7) Color button*

Starts color copying. You can also press this button to finalize your selection for the setting item.

* In the software applications or manuals, the **Color** and **Black** buttons are collectively called the "Start" or "OK" button.

Power Supply

- **Confirming that the Power Is On**
- **Turning the Machine On and Off**
- **Notice for the Power Plug/Power Cord**
- **Notice for Unplugging the Power Cord**

Confirming that the Power Is On

The **ON** lamp is lit when the machine is turned on.



▶▶ Note

- It may take a while for the machine to start printing immediately after you turn on the machine.

Turning the Machine On and Off

Turning on the machine

1. Press the **ON** button to turn on the machine.

The **ON** lamp flashes and then remains lit.

- [Confirming that the Power Is On](#)

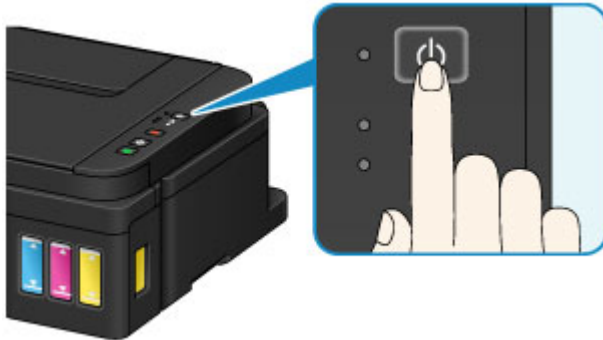

►► Note

- It may take a while for the machine to start printing immediately after you turn on the machine.
- If the **Alarm** lamp lights up or flashes, see [An Error Occurs](#).
- You can set the machine to automatically turn on when a print or scan operation is performed. This feature is set to off by default.

- [Managing the Printer Power \(Windows\)](#)
- [Managing the Printer Power \(Mac OS\)](#)

Turning off the machine

1. Press the **ON** button to turn off the machine.

When the **ON** lamp stops flashing, the machine is turned off.

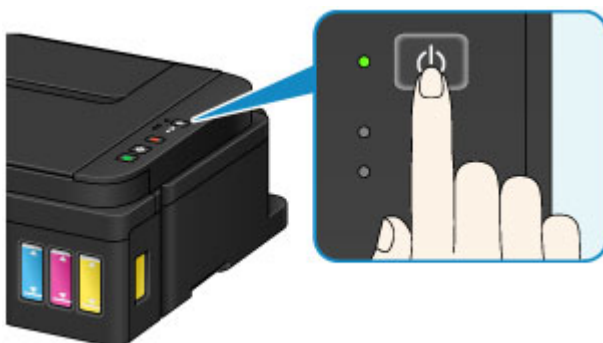

►► Important

- When you [unplug the power cord](#) after turning off the machine, be sure to confirm that the **ON** lamp is off.

»» Note

- You can set the machine to automatically turn off when no operations are performed or no print jobs are sent to the machine for a certain interval. This feature is set to on by default.
 - Managing the Printer Power (Windows)
 - [Managing the Printer Power](#) (Mac OS)

Notice for the Power Plug/Power Cord

Unplug the power cord once a month to confirm that the power plug/power cord does not have anything unusual described below.

- The power plug/power cord is hot.
- The power plug/power cord is rusty.
- The power plug/power cord is bent.
- The power plug/power cord is worn.
- The power plug/power cord is split.

Caution

- If you find anything unusual with the power plug/power cord described above, [unplug the power cord](#) and call for service. Using the machine with one of the unusual conditions above may cause a fire or an electric shock.

Notice for Unplugging the Power Cord

To unplug the power cord, follow the procedure below.

▶▶▶ Important

- When you unplug the power cord, press the **ON** button, then confirm that the **ON** lamp is off. Unplugging the power cord while the **ON** lamp is lit or flashing may cause drying or clogging of the print head and print quality may be reduced.

1. Press the **ON** button to turn the machine off.

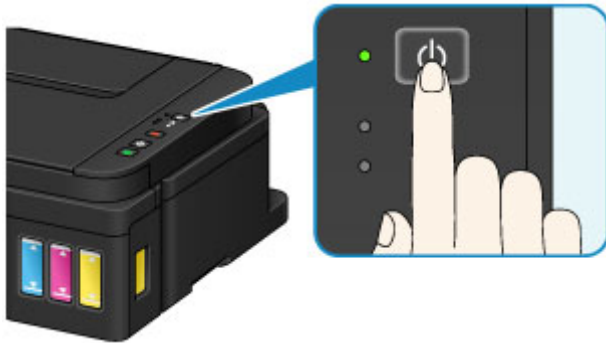

2. Confirm that the **ON** lamp is off.



3. Unplug the power cord.

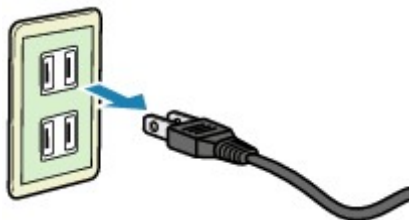

The specification of the power cord differs depending on the country or region of use.

Changing Settings

- ▶ **Changing Printer Settings from Your Computer (Windows)**
- ▶ **Changing Printer Settings from Your Computer (Mac OS)**
- ▶ **Changing Settings from Operation Panel**
- ▶ **Initializing Machine Settings**

Changing Printer Settings from Your Computer (Mac OS)

- **Registering a Changed Printing Profile**
- **Changing the remaining ink level notification setting**
- **Managing the Printer Power**
- **Reducing the Printer Noise**
- **Changing the Printer Operation Mode**

Registering a Changed Printing Profile

You can name and register the printing profile you made in the [Print Dialog](#). The registered printing profile can be called up from **Presets** to be used. You can also delete the unnecessary printing profile.

The procedure for registering a printing profile is as follows:

Registering a Printing Profile

1. In the Print dialog, set the necessary items
2. Select **Save Current Settings as Preset...** from the **Presets**

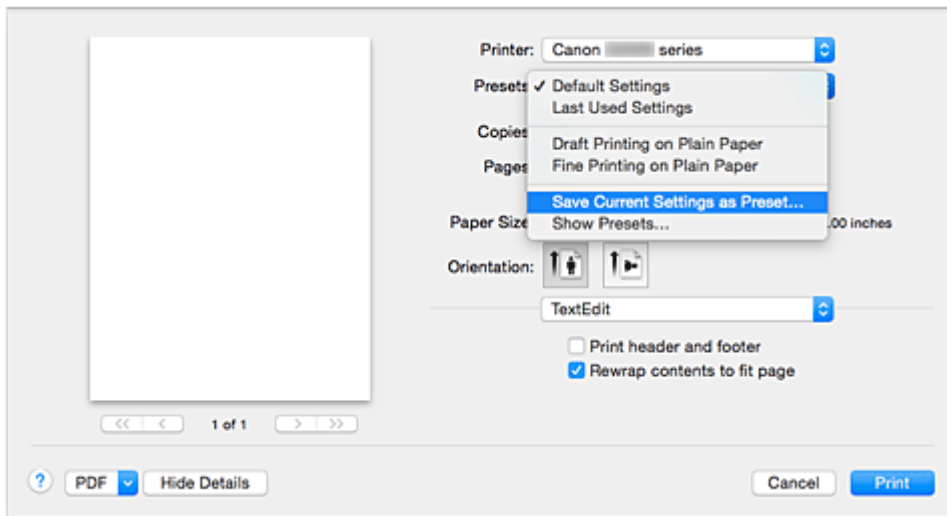

3. Save the settings

In the displayed dialog, enter a name in **Preset Name**, and if necessary, set **Preset Available For**. Then click **OK**.

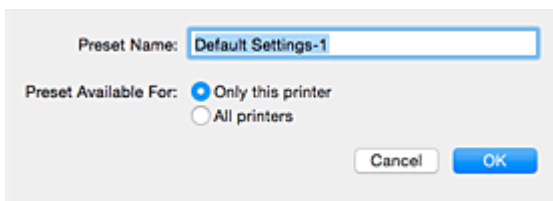

Important

- There are also print settings that cannot be saved to preset.

Using Registered Printing Profile

1. On **Presets** in the Print dialog, select the name of printing profile you want to use
Printing profile in the Print dialog will be updated to the called profile.

Deleting Unnecessary Printing Profile

1. Select the printing profile to be deleted

In the print dialog, select **Show Presets...** in the **Presets** section. Then in the dialog that appears, select the name of the printing profile to be deleted.

2. Delete the printing profile

Click **Delete**, and click **OK**. The selected printing profiles will be deleted from **Presets**.

Changing the remaining ink level notification setting

You can switch the remaining ink level notification setting and reset the remaining ink level count.

This section describes the procedure for changing the remaining ink level notification setting.



Remaining Ink Notification Settings

You can switch the remaining ink level notification setting.

1. From the [Canon IJ Printer Utility](#) pop-up menu, select **Remaining ink level setting**.
2. Check that the printer is on, and click **Remaining Ink Notification Settings**.

The dialog appears.

3. Set the remaining ink level notification.

Select **Enable** to display an error message when the remaining ink level runs low.

Select **Disable** to prevent the error message from being displayed.

▶▶▶ Important

- Before enabling **Remaining Ink Notification Settings**, [replenish](#) all inks to the upper limit line and reset the remaining ink level count by running **Resets the Remaining Ink Level Count**. However, if you reset the count by operating the operation panel of the printer, the setting in the printer driver is unnecessary.
- If you disable **Remaining Ink Notification Settings**, you must visually check the remaining ink level. Replenish the ink before the ink level falls below the lower limit line.

4. Apply the setting.

Click **OK**.

When the confirmation message appears, click **OK**.

From this point on, the setting is applied.



Resets the Remaining Ink Level Count

You can reset the remaining ink level notification counter.

1. From the [Canon IJ Printer Utility](#) pop-up menu, select **Remaining ink level setting**.
2. Check that the printer is on, and then click **Resets the Remaining Ink Level Count**.

The dialog appears.

3. Apply the setting.

Click **OK**.

When the confirmation message appears, click **OK**.

The remaining ink level notification counter is reset.

»» Important

- When you reset the remaining ink level counter, you must replenish all inks to the upper limit line.

Managing the Printer Power

This function allows you to manage the printer power from the printer driver.

The procedure for managing the printer power is as follows:



Power Off

The **Power Off** function turns off the printer. When you use this function, you will not be able to turn the printer on from the printer driver.

1. Select **Power Settings** from the pop-up menu on the [Canon IJ Printer Utility](#)
2. Execute power off

Click **Power Off**, and when the confirmation message appears, click **OK**.
The printer power switches off.



Auto Power

Auto Power allows you to set **Auto Power On** and **Auto Power Off**.

The **Auto Power On** function automatically turns on the printer when data is received.

The **Auto Power Off** function automatically turns off the printer when there are no operations from the printer driver or the printer for a specified period of time.

1. Select **Power Settings** from the pop-up menu on the [Canon IJ Printer Utility](#)
2. Check that the printer is on, and then click **Auto Power**

A dialog appears.

▶▶▶ Note

- If the printer is off or if communication between the printer and the computer is disabled, an error message may appear because the computer cannot collect the printer status.

3. If necessary, complete the following settings:

Auto Power On

Specifying **Enable** from the list and clicking **OK** will turn the printer on upon receipt of print data.

Auto Power Off

Specify the time from the list. When this time lapses without any operations from the printer driver or the printer, the printer is turned off automatically.

4. Apply the settings

When the confirmation message appears, click **OK**.

The setting is enabled after this. When you want to disable this function, select **Disable** from the list according to the same procedure.

Reducing the Printer Noise

The silent function allows you to reduce the operating noise of this printer. Select when you wish to reduce the operating noise of the printer at night, etc.

Using this function may lower the print speed.

The procedure for using the quiet mode is as follows:

1. Select **Quiet Settings** from the pop-up menu on the [Canon IJ Printer Utility](#)

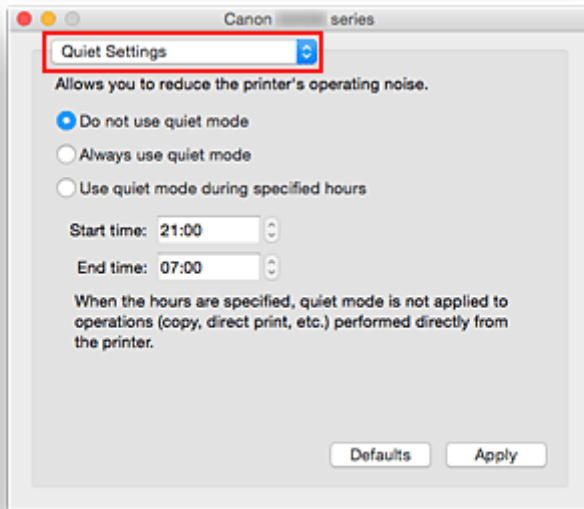

►► Note

- If the computer is unable to communicate with the printer, a message may be displayed because the computer cannot access the function information that was set on the printer. If this happens, click **Cancel** to display the most recent settings specified on your computer.

2. Set the quiet mode

If necessary, specify one of the following items:

Do not use quiet mode

Select this option when you wish to use the printer with volume of normal operating noise.

Always use quiet mode

Select this option when you wish to reduce the operating noise of the printer.

Use quiet mode during specified hours

Select this option when you wish to reduce the operating noise of the printer during a specified period of time.

Set the **Start time** and the **End time** of the quiet mode you wish to be activated. If both are set to the same time, the quiet mode will not function.

▶▶▶ Important

- You can set the quiet mode from the operation panel of the printer or the printer driver. No matter how you use to set the quiet mode, the mode is applied when you perform operations from the operation panel of the printer or printing and scanning from the computer.
- If you specify a time for **Use quiet mode during specified hours**, quiet mode is not applied to operations (copy, direct print, etc.) performed directly from the printer.

3. Apply the settings

Make sure that the printer is on and click **Apply**.

Click **OK** when the confirmation message appears.

The settings are enabled hereafter.

▶▶▶ Note

- The effects of the quiet mode may be less depending on the print quality settings.

Changing the Printer Operation Mode

If necessary, switch between various modes of printer operation.

The procedure for configuring **Custom Settings** is as follows:

1. Make sure that the printer is on, and then select **Custom Settings** from the pop-up menu on the [Canon IJ Printer Utility](#)

▶▶▶ Note

- If the computer is unable to communicate with the printer, a message may be displayed because the computer cannot access the function information that was set on the printer. If this happens, click **Cancel** to display the most recent settings specified on your computer.

2. If necessary, complete the following settings:

Ink Drying Wait Time

You can set the length of the printer rest time until printing of the next page begins. Moving the slider to the right increases the pause time, and moving the slider to the left decreases the time.

If the paper gets stained because the next page is ejected before the ink on the printed page dries, increase the ink drying wait time.

Reducing the ink drying wait time speeds up printing.

Prevent paper abrasion

The printer can increase the gap between the print head and the paper during high-density printing to prevent paper abrasion.

Check this check box to prevent paper abrasion.

Align heads manually

Usually, the **Print Head Alignment** function of **Test Print** on the pop-up menu in the Canon IJ Printer Utility is set to automatic head alignment, but you can change it to manual head alignment.

If the printing results of automatic print head alignment are not satisfactory, [perform manual head alignment](#).

Check this check box to perform the manual head alignment. Uncheck this check box to perform the automatic head alignment.

3. Apply the settings

Click **Apply** and when the confirmation message appears, click **OK**.

The printer operates with the modified settings hereafter.

Changing Settings from Operation Panel

- ▶ **Quiet setting**
- ▶ **Turning on/off Machine Automatically**

Quiet setting

Enable this function on the machine if you want to reduce the operating noise, such as when printing at night.

Follow the procedure below to perform setting.

1. [Make sure machine is turned on.](#)
2. Press and hold **Stop** button and release it when **Alarm** lamp flashes 13 times.
3. Press **Color** button.

To disable the function, press the **Black** button.

Important

- Operating speed is reduced compared to when the quiet mode is not selected.

Note

- You can set the quiet mode from the operation panel of the machine or the machine driver. No matter how you set the quiet mode, the mode is applied when you perform operations from the operation panel of the machine or printing and scanning from the computer.
- For Windows, you can set the quiet mode from ScanGear (scanner driver).

Turning on/off Machine Automatically

You can enable the machine to turn on/off automatically considering the environment.

■ [Turning on Machine Automatically](#)

■ [Turning off Machine Automatically](#)

Turning on Machine Automatically

You can enable the machine to turn on automatically when a scanning command from a computer or printing data is sent to the machine.

1. [Make sure machine is turned on.](#)
2. Press and hold **Stop** button and release it when **Alarm** lamp flashes 18 times.
3. Press **Color** button.

To disable the function, press the **Black** button.

▶▶▶ Note

- You can select whether you turn the machine on automatically from the operation panel of the machine or the printer driver. No matter how you set the mode, the mode is applied when you perform printing or scanning operations from the computer.
- For Windows, you can select whether you turn the machine on automatically from ScanGear (scanner driver).

Turning off Machine Automatically

You can enable the machine to turn off automatically when no operation is made or no printing data is sent to the machine for a specified period of time.

1. [Make sure machine is turned on.](#)
2. Press and hold **Stop** button and release it when **Alarm** lamp flashes 17 times.
3. Press **Color** button.

To disable the function, press the **Black** button.

▶▶▶ Note

- You can select whether you turn off the machine automatically from the operation panel of the machine or the printer driver. From the printer driver, you can specify the time before turning off the machine.
- For Windows, you can select whether you turn off the machine automatically from ScanGear (scanner driver). From ScanGear (scanner driver), you can specify the time before turning off the machine.

Initializing Machine Settings

You can initialize the machine settings.

To initialize the machine settings, press and hold the **Stop** button and release it when the **Alarm** lamp flashes 24 times.

All the machine settings are initialized.

After initializing the machine, perform setup again as necessary.

Note

- You cannot set the current position of the print head back to the default.

Ensuring Optimal Printing Results

- ▶ **Ink Tips**
- ▶ **Printing Tips**
- ▶ **Be Sure to Make Paper Settings after Loading Paper**
- ▶ **Canceling a Print Job**
- ▶ **Machine Handling Precautions**
- ▶ **Keeping Print Quality High**
- ▶ **Transporting Your Printer**

Ink Tips

How is ink used for various purposes other than printing?

Ink may be used for purposes other than printing.

During initial setup, some of the ink from the bundled ink bottles is used to fill the print head's nozzles to ensure the printer is print-ready.

Therefore, the page yield of the initial bundled set of ink bottles is lower than that of the subsequent sets of bottles.

To keep printer's performance, Canon printer performs cleaning automatically according to its condition. When the printer performs cleaning, a small amount of ink is consumed. In this case, all colors of ink may be consumed.

[Cleaning function]

The cleaning function helps the printer to suck air bubbles or ink itself from the nozzle and thus prevents print quality degradation or nozzle clogging.

Does black-and-white printing use color ink?

Black-and-white printing may use ink other than black ink depending on the type of printing paper or the settings of the printer driver. So, color ink is consumed even when printing in black-and-white.

Similarly, color inks are also consumed along with black ink during print head cleaning when Black is specified for cleaning.

Printing Tips

Check the machine status before printing!

- Is the print head OK?

If a print head nozzle is clogged, print will be faint and papers will be wasted. Print the nozzle check pattern to check the print head.

■ [Maintenance Procedure](#)

- Is the inside of the machine smeared with ink?

After printing large quantities of paper or performing borderless printing, the area where papers go through may get smeared with ink. Clean the inside of your machine with [Bottom Plate Cleaning](#).

Check how to load the paper correctly!

- Is the paper loaded in the correct orientation?

To load paper in the rear tray, load paper WITH THE PRINTING SIDE FACING YOU.

■ [Loading Paper](#)



- Is the paper curled?

The curled paper causes paper jam. Flatten the curled paper, then reload it.

■ "Correct curl before loading paper." in [Paper Is Smudged / Printed Surface Is Scratched](#)

Be Sure to Make Paper Settings after Loading Paper

If the media type setting is not the one for the loaded paper, printing results may not be satisfactory. After loading paper, be sure to select the appropriate media type setting for the loaded paper.

■ [Print Results Are Unsatisfactory](#)

There are various types of paper: paper with special coating on the surface for printing photos with optimal quality and paper suitable for documents.

Each media type has specific preset settings, such as how ink is used and sprayed, distance from nozzles, etc., so that you can print on that type with optimal image quality.

This allows you to print with the settings best suited for the loaded media type just by selecting that media type.

Canceling a Print Job

Never press the ON button!

If you press the **ON** button while printing is in progress, the print data sent from the computer queues in the machine and you may not be able to continue to print.

Press the **Stop** button to cancel printing.

Machine Handling Precautions

Do not place any object on the document cover!

Do not place any object on the document cover. It will fall into the rear tray when the document cover is opened and cause the machine to malfunction. Also, place the machine where objects will not fall on it.



Keeping Print Quality High

The key to printing with the optimal printing quality is to prevent the print head from drying or clogging. Always observe the following rules for optimal printing quality.

»» Note

- Depending on the type of paper, ink may blur if you trace the printed area with a highlight pen or paint-stick, or bleed if water or sweat comes in contact with the printed area.

Never unplug the power cord until the power is turned off!

If you press the **ON** button to turn off the power, the machine caps the print head (nozzles) automatically to prevent from drying. If you unplug the power cord from the wall outlet before the **ON** lamp is turned off, the print head will not be capped properly and this will cause drying or clogging.

When [unplugging the power cord](#), make sure that the **ON** lamp is not lit.

Print periodically!

Just as the tip of a felt pen becomes dry and unusable if it has not been used for a long time, even if it is capped, the print head too, may become dried or clogged if the machine has not been used for a long time. We recommend you to use the machine at least once a month.

Transporting Your Printer

When relocating the machine for changing your living place or repairing it, make sure of the following.

▶▶▶ Important

- You cannot take ink out of ink tanks.
- Check if the tank cap is completely inserted. If the ink tank cover is not completely closed, insert the tank cap properly.
- Do not tilt the machine. Ink may leak.
- Please handle with care and ensure the box remains flat and NOT turned upside down or on its side, as the printer may be damaged and ink in the printer may leak.
- Pack the machine in a sturdy box so that it is placed with its bottom facing down, using sufficient protective material to ensure safe transport.
- With the cartridge left installed in the machine, press the **ON** button to turn off the power. This allows the machine to automatically cap the print head, thus preventing it from drying.
- Do not remove the cartridge. Ink may leak.
- When transporting the machine, pack the machine in a plastic bag so that ink does not leak.
- When a shipping agent is handling transport of the machine, have its box marked "THIS SIDE UP" to keep the machine with its bottom facing down. Mark also with "FRAGILE" or "HANDLE WITH CARE".

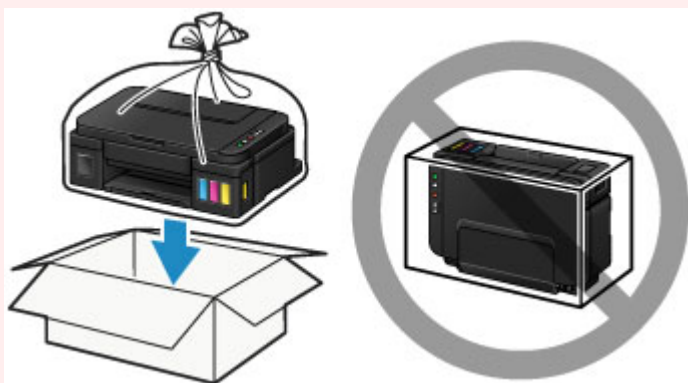

1. Make sure the machine is on.
2. Hold down the **Stop** button until the **Alarm** lamp flashes seven times, then release it immediately.

The preparation to transport is executed and the machine goes off after the preparation is complete.

Do not perform any other operations until the machine completes the preparation.

3. Confirm that the **ON** lamp is off and [unplug the power cord](#).

▶▶▶ Important

- Do not unplug the machine while the **ON** lamp is lit or flashing, as it may cause malfunction or damage to the machine, making the machine unable to print.

4. Retract the paper output tray and the output tray extension, then close the paper support.

5. Unplug the printer cable from the computer and from the machine, then unplug the power cord from the machine.
6. Use adhesive tape to secure all the covers on the machine to keep them from opening during transportation. Then pack the machine in the plastic bag.



7. Attach the protective material to the machine when packing the machine in the box.

Legal Restrictions on Scanning/Copying

It may be unlawful to make copies of, scan, print, or use reproductions of the following documents.

The list provided is non-exhaustive. When in doubt, check with a legal representative in your jurisdiction.

- Paper money
- Money orders
- Certificates of deposit
- Postage stamps (canceled or uncanceled)
- Identifying badges or insignias
- Selective service or draft papers
- Checks or drafts issued by governmental agencies
- Motor vehicle licenses and certificates of title
- Traveler's checks
- Food stamps
- Passports
- Immigration papers
- Internal revenue stamps (canceled or uncanceled)
- Bonds or other certificates of indebtedness
- Stock certificates
- Copyrighted works/works of art without permission of copyright owner

Specifications

General Specifications

Printing resolution (dpi)	4800* (horizontal) x 1200 (vertical) * Ink droplets can be placed with a pitch of 1/4800 inch at minimum.
Interface	USB Port: Hi-Speed USB * * A computer that complies with Hi-Speed USB standard is required. Since the Hi-Speed USB interface is fully upwardly compatible with USB 1.1, it can be used at USB 1.1.
Print width	8 inches/203.2 mm (for Borderless Printing: 8.5 inches/216 mm)
Operating environment	Temperature: 41 to 95 °F (5 to 35 °C) Humidity: 10 to 90 % RH (no condensation) * The performance of the printer may be reduced under certain temperature and humidity conditions. Recommended conditions: Temperature: 59 to 86 °F (15 to 30 °C) Humidity: 10 to 80 % RH (no condensation) * For the temperature and humidity conditions of papers such as photo paper, refer to the paper's packaging or the supplied instructions.
Storage environment	Temperature: 32 to 104 °F (0 to 40 °C) Humidity: 5 to 95 % RH (no condensation)
Power supply	AC 100-240 V, 50/60 Hz
Power consumption	Printing (Copy): Approx. 11 W Standby (minimum): Approx. 0.8 W *1*2 OFF: Approx. 0.4 W *1 *1 USB connection to PC *2 The wait time for standby cannot be changed.
External dimensions	Approx. 17.6 (W) x 13 (D) x 6.5 (H) inches Approx. 445 (W) x 330 (D) x 163 (H) mm * With the Paper Output Tray retracted.
Weight	Approx. 12.7 lb (Approx. 5.8 kg) * With the Print Head and ink tanks installed.
Print Head/Ink	Total 1472 nozzles (BK 320 nozzles, C/M/Y each 384 nozzles)

Copy Specifications

Multiple copy	max. 21 pages
---------------	---------------

Scan Specifications

Scanner driver	Windows: TWAIN 1.9 Specification, WIA Mac OS: ICA
Maximum scanning size	A4/Letter, 8.5" x 11.7"/216 x 297 mm
Scanning resolution	Optical resolution (horizontal x vertical) max: 600 x 1200 dpi *1 Interpolated resolution max: 19200 x 19200 dpi *2 *1 Optical Resolution represents the maximum sampling rate based on ISO 14473. *2 Increasing the scanning resolution will limit the maximum possible scanning area.
Gradation (Input / Output)	Gray: 16 bit/8 bit Color: 48 bit/24 bit (RGB each 16 bit/8 bit)

Minimum System Requirements

Conform to the operating system's requirements when higher than those given here.

Windows

Operating System	Windows 10, Windows 8.1*, Windows 8 Windows 7, Windows 7 SP1 Windows Vista SP2 Windows XP SP3 32-bit only * Windows 8.1 includes Windows 8.1 Update.
Hard Disk Space	3.1 GB Note: For bundled software installation. The necessary amount of hard disk space may be changed without notice.
Display	XGA 1024 x 768

Mac OS

Operating System	OS X v10.7.5 - OS X v10.11
Hard Disk Space	1.5 GB Note: For bundled software installation. The necessary amount of hard disk space may be changed without notice.
Display	XGA 1024 x 768

Other Supported OS

This product cannot be used with the iOS, Android, Windows RT, and Windows 10 Mobile.

- An internet connection is required to use Easy-WebPrint EX and all the *Online Manual*.
- Windows: Operation can only be guaranteed on a computer with Windows 10, Windows 8.1, Windows 8, Windows 7, Windows Vista or Windows XP pre-installed.
- Windows: A CD-ROM Drive or internet connection is required during software installation.
- Windows: Internet Explorer 8, 9, 10 or 11 is required to install Easy-WebPrint EX.
- Windows: Some functions may not be available with Windows Media Center.
- Windows: .NET Framework 4 or 4.5 must be installed to use the Windows software.
- Windows: XPS Essentials Pack is required to print on Windows XP.
- Windows: The TWAIN driver (ScanGear) is based on the TWAIN 1.9 Specification and requires the Data Source Manager bundled with the operating system.
- Mac OS: For Mac OS, an internet connection is required during software installation.

Information in this guide is subject to change without notice.

Information about Paper

▶ **Media Types You Can Use**

- Paper Load Limit

▶ **Media Types You Cannot Use**

▶ **Printing Area**

- Printing Area
- Other Sizes than Letter, Legal, Envelopes
- Letter, Legal
- Envelopes

Media Types You Can Use

To get the best printing result, choose paper suitable for printing. Canon provides various types of paper suitable for documents as well as paper suitable for photos or illustrations. We recommend the use of Canon genuine paper for printing your important photos.

Media Types

Commercially available papers

- Plain Paper (including recycled paper)*[1](#)
- Envelopes

Canon genuine papers

The Model Number of Canon genuine paper is shown in brackets. Refer to the instruction manual supplied with the paper for detailed information on the printable side and notes on handling paper. For information on the page sizes available for each Canon genuine paper, access our website.

▶▶▶ Note

- You may not be able to purchase some Canon genuine papers depending on the country or region of purchase. Paper is not sold in the US by Model Number. Purchase paper by name.

Paper for printing documents:

- Canon Red Label Superior <WOP111>*[1](#)
- Canon Océ Office Colour Paper <SAT213>*[1](#)

Paper for printing photos:

- Glossy Photo Paper "Everyday Use" <GP-501>
- Photo Paper Glossy <GP-701>
- Photo Paper Plus Glossy II <PP-201>
- Photo Paper Plus Glossy II <PP-301>
- Photo Paper Pro Luster <LU-101>
- Photo Paper Plus Semi-gloss <SG-201>
- Matte Photo Paper <MP-101>

Paper for printing business documents:

- High Resolution Paper <HR-101N>

*1 This machine accepts only A4 or Letter-sized plain paper for copying.

■ [Paper Load Limit](#)

■ Paper Settings on the Printer Driver (Windows)

■ [Paper Settings on the Printer Driver](#) (Mac OS)

Page Sizes

You can use the following page sizes.

▶▶ Note

- Only the following sizes may be printed from the operation panel.
 - A4, Letter

Standard sizes:

- Letter
- Legal
- A5
- A4
- B5
- KG/4"x6"(10x15)
- 2L/5"x7"(13x18)
- 8"x10"(20x25cm)
- L(89x127mm)
- Square 5"x5" 13x13cm
- Hagaki
- Hagaki 2
- Envelope Com 10
- Envelope DL
- Nagagata 3
- Nagagata 4
- Yougata 4
- Yougata 6
- Card 2.17"x3.58" 55x91mm

Non-standard sizes:

You can print on non-standard size paper within the following ranges.

- Minimum size: 2.17 x 3.50 inches (55.0 x 89.0 mm)
- Maximum size: 8.50 x 26.61 inches (215.9 x 676.0 mm)

Paper Weight

You can use paper in the following weight range.

- 17 to 28 lb (64 to 105 g /m²) (plain paper except for Canon genuine paper)

Do not use heavier or lighter paper (except for Canon genuine paper), as it could jam in the machine.

Notes on Storing Paper

- Take out only the necessary number of paper from the package, just before printing.
- To avoid curling, when you do not print, put unused paper back into the package and keep it on a level surface. And also, store it avoiding heat, humidity, and direct sunlight.

Paper Load Limit

Commercially Available Papers

Media Name	Rear Tray	Paper Output Tray
Plain Paper (including recycled paper)* 1	Approx. 100 sheets (10 sheets: Legal)	Approx. 50 sheets (10 sheets: Legal)
Envelopes	10 envelopes	*2

Canon Genuine Papers

▶▶▶ Note

- We recommend that you remove the previously printed sheet from the paper output tray before continuously printing to avoid blurs and discoloration (except for Canon Red Label Superior <WOP111>, Canon Océ Office Colour Paper <SAT213>, and High Resolution Paper <HR-101N>).

Paper for printing documents:

Media Name <Model No.>	Rear Tray	Paper Output Tray
Canon Red Label Superior <WOP111>	Approx. 100 sheets	Approx. 50 sheets
Canon Océ Office Colour Paper <SAT213>	Approx. 80 sheets	Approx. 50 sheets

Paper for printing photos:

Media Name <Model No.>	Rear Tray
Glossy Photo Paper "Everyday Use" <GP-501> *3	10 sheets: A4, Letter 20 sheets: 4" x 6" (10 x 15 cm)
Photo Paper Glossy <GP-701> *3	10 sheets: A4, Letter 20 sheets: 4" x 6" (10 x 15 cm)
Photo Paper Plus Glossy II <PP-201> *3	10 sheets: A4, Letter, 5" x 7" (13 x 18 cm), 8" x 10" (20 x 25 cm) 20 sheets: 4" x 6" (10 x 15 cm), Square 5" x 5" (13 x 13 cm)
Photo Paper Plus Glossy II <PP-301> *3	10 sheets: A4, Letter, 5" x 7" (13 x 18 cm), 8" x 10" (20 x 25 cm) 20 sheets: 4" x 6" (10 x 15 cm), Square 5" x 5" (13 x 13 cm)
Photo Paper Pro Luster <LU-101> *3	10 sheets: A4, Letter
Photo Paper Plus Semi-gloss <SG-201> *3	10 sheets: A4, Letter, 5" x 7" (13 x 18 cm), 8" x 10" (20 x 25 cm) 20 sheets: 4" x 6" (10 x 15 cm)
Matte Photo Paper <MP-101>	10 sheets: A4, Letter

20 sheets: 4" x 6" (10 x 15 cm)

Paper for printing business documents:

Media Name <Model No.>	Rear Tray	Paper Output Tray
High Resolution Paper <HR-101N>	80 sheets	50 sheets

*1 Proper feeding of paper may not be possible at the maximum capacity depending on the type of paper or environmental conditions (either very high or low temperature or humidity). In such cases, reduce the number of paper you load at a time to less than half.

*2 We recommend that you remove the previously printed paper or envelope from the paper output tray before continuously printing to avoid blurs and discoloration.

*3 When loading paper in stacks, the print side may become marked as it is fed or paper may not feed properly. In this case, load one sheet at a time.

Media Types You Cannot Use

Do not use the following types of paper. Using such paper will cause not only unsatisfactory results, but also the machine to jam or malfunction.

- Folded, curled, or wrinkled paper
- Damp paper
- Paper that is too thin (weighing less than 17 lb (64 g /m²))
- Paper that is too thick (plain paper weighing more than 28 lb (105 g /m²), except for Canon genuine paper)
- Plain paper or notepad paper cut to a small size (when printing on paper smaller than A5)
- Picture postcards
- Postcards affixed with photos or stickers
- Envelopes with a double flap
- Envelopes with an embossed or treated surface
- Envelopes whose gummed flaps are already moistened and adhesive
- Any type of paper with holes
- Paper that is not rectangular
- Paper bound with staples or glue
- Paper with adhesives
- Paper decorated with glitter, etc.

Printing Area

- ▶ **Printing Area**
- ▶ **Other Sizes than Letter, Legal, Envelopes**
- ▶ **Letter, Legal**
- ▶ **Envelopes**

Printing Area

To ensure the best print quality, the machine allows a margin along each edge of media. The actual printable area will be the area inside these margins.

Recommended printing area  : Canon recommends that you print within this area.

Printable area  : The area where it is possible to print. However, printing in this area can affect the print quality or the paper feed precision.

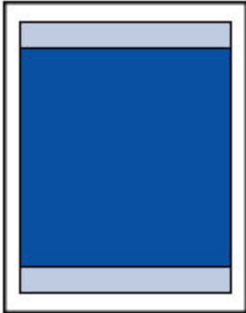

▶▶▶ Note

- By selecting Borderless Printing option, you can make prints with no margins.
- When performing Borderless Printing, slight cropping may occur at the edges since the printed image is enlarged to fill the whole page.
- For Borderless Printing, use the following paper:
 - Glossy Photo Paper "Everyday Use" <GP-501>
 - Photo Paper Glossy <GP-701>
 - Photo Paper Plus Glossy II <PP-201>
 - Photo Paper Plus Glossy II <PP-301>
 - Photo Paper Pro Luster <LU-101>
 - Photo Paper Plus Semi-gloss <SG-201>
 - Matte Photo Paper <MP-101>

Performing Borderless Printing on any other type of paper may substantially reduce printing quality and/or result in printouts with altered color hues.

Borderless Printing on plain paper may result in printouts with reduced quality. Use them only for test printing. Borderless Printing from the operation panel is not supported. This machine only supports Borderless Printing from a computer.

- Borderless Printing is not available for A5, B5, or Legal size paper, or envelopes.
- Depending on the type of paper, Borderless Printing may reduce the print quality at the top and bottom edges of the paper or cause these parts to become smudged.

Other Sizes than Letter, Legal, Envelopes

Size	Printable Area (width x height)
A5	5.56 x 7.95 inches (141.2 x 202.0 mm)
A4	8.00 x 11.38 inches (203.2 x 289.0 mm)
B5	6.90 x 9.80 inches (175.2 x 249.0 mm)
4" x 6" (10 x 15 cm)	3.73 x 5.69 inches (94.8 x 144.4 mm)
5" x 7" (13 x 18 cm)	4.73 x 6.69 inches (120.2 x 169.8 mm)
8" x 10" (20 x 25 cm)	7.73 x 9.69 inches (196.4 x 246.0 mm)
Square 5" x 5" (13 x 13 cm)	4.53 x 4.53 inches (115.0 x 115.0 mm)
Card 2.17" x 3.58" (55 x 91 mm)	1.89 x 3.26 inches (48.2 x 83.0 mm)

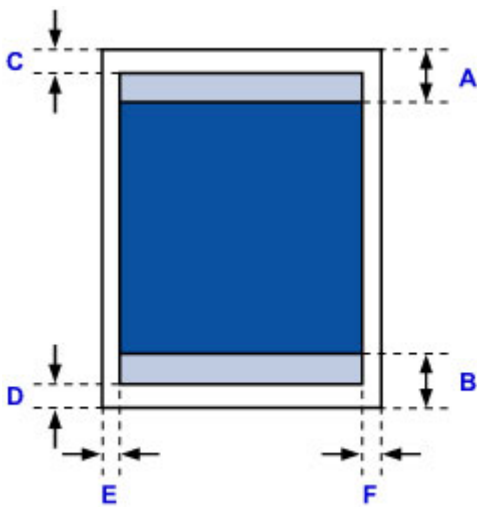

Recommended printing area

A: 1.23 inches (31.2 mm)

B: 1.28 inches (32.5 mm)

Printable area

Other than Square size

C: 0.12 inch (3.0 mm)

D: 0.20 inch (5.0 mm)

E: 0.13 inch (3.4 mm)

F: 0.13 inch (3.4 mm)

Square size

C: 0.23 inch (6.0 mm)

D: 0.23 inch (6.0 mm)

E: 0.23 inch (6.0 mm)

F: 0.23 inch (6.0 mm)

Letter, Legal

Size	Printable Area (width x height)
Letter	8.00 x 10.69 inches (203.2 x 271.4 mm)
Legal	8.00 x 13.69 inches (203.2 x 347.6 mm)

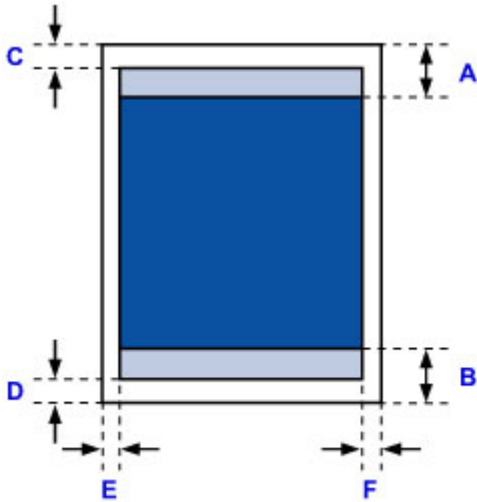

Recommended printing area

A: 1.23 inches (31.2 mm)

B: 1.28 inches (32.5 mm)

Printable area

C: 0.12 inch (3.0 mm)

D: 0.20 inch (5.0 mm)

E: 0.25 inch (6.4 mm)

F: 0.25 inch (6.3 mm)

Envelopes

Size	Recommended Printing Area (width x height)
Envelope DL	4.06 x 7.20 inches (103.2 x 183.0 mm)
Envelope Com 10	3.85 x 8.04 inches (97.9 x 204.3 mm)

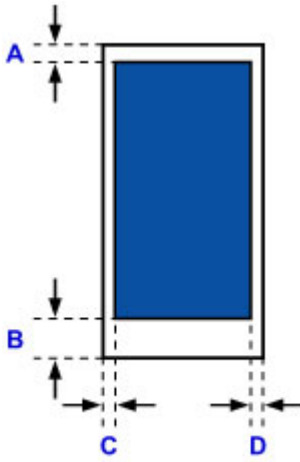

 Recommended printing area

A: 0.31 inch (8.0 mm)

B: 1.14 inches (29.0 mm)

C: 0.13 inch (3.4 mm)

D: 0.13 inch (3.4 mm)

Administrator Password

Depending on the printer you are using, an administrator password is specified at the time of purchase. The password is either "canon" or the printer serial number if it is specified.

Model whose administrator password is specified as "canon":

- The administrator password is specified as "canon" for the models below.
MG7500 series, MG6700 series, MG6600 series, MG5600 series
MG2900 series, MX490 series, MB5300 series, MB5000 series
MB2300 series, MB2000 series, E480 series, E460 series
iP110 series, iB4000 series, PRO-100S series, PRO-10S series
- At the time of purchase, the user name "ADMIN" is also specified for the models above.
- The following character restrictions apply to the password that you change:
 - Set the password by using 0 to 32 characters.
 - The allowed characters are single-byte alphanumeric characters.
 - For security reasons, we recommend you use 6 and more alphanumeric characters.

Model whose serial number is used as the administrator password:

- For the models other than the above, the printer serial number is used as the administrator password.
[■ Where Serial Number Is Located](#)
- The following character restrictions apply to the password that you change:
 - Set the password by using 4 to 32 characters.
 - The allowed characters are single-byte alphanumeric characters.
 - For security reasons, we recommend you use 6 and more alphanumeric characters.

Important

- You can change the password using one of the tools below. (Some tools may not be available depending on the printer you are using.)
 - operation panel of the printer
 - IJ Network Tool
 - printer information screen displayed on some Canon application software
- If the password has been changed while you are sharing the printer and you do not know the password, ask the administrator of the printer you are using.
- Set the password back to the default setting by initializing the printer settings.

For more on initializing the printer, search for "UG067" or "UG505" on your printer's Online Manual and see the instructions shown.

Authentication

Enter the password when the authentication screen is displayed.

■ Administrator Password

You need to enter the user name as well as the password depending on the printer you are using. For more on the user name, see the link above.

▶▶▶ Important

- A message to warn you that the identification information is not verified may be displayed depending on the printer you are using.
- For security reasons, we recommend you change the password.

▶▶▶ Note

- Use an OS or web browser below to use **Remote UI**.
 - iOS devices:
 - OS: iOS 6.1 or later
 - Browser: Default browser of iOS device (Mobile Safari)
 - Android devices:
 - OS: Android 2.3.3 or later
 - Browser: Default browser of Android device (browser or Chrome)
 - Mac OS devices:
 - OS: Mac OS X v.10.6 or later
 - Browser: Safari 5.1 or later
 - Windows devices:
 - OS: Windows XP or later
 - Browser: Internet Explorer 8 or later / Google Chrome 38.0.2125.104m or later / Mozilla Firefox 33.0 or later

Where Serial Number Is Located

The printer serial number is printed on the sticker attached on the printer. It consists of 9 alphanumeric characters (four alphabets followed by five numbers).

Example:

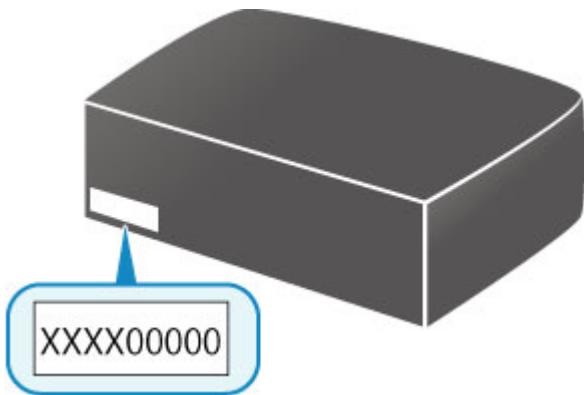

▶▶ Note

- The printer serial number is written on the warranty.
- Depending on the printer you are using, you can check the serial number by printing out the network setting information of the printer. For more on printing, search for "NR044" on your printer's Online Manual and see the instructions shown.

List of Function for Each Model

See below to check the models you can/cannot use the card slot via a network.

■ [MG series](#)

■ [MX series / MB series / E series / P series / iP series / iX series / iB series / PRO series / G series](#)

MG series

Model name	Using the card slot via a network
MG7700 series	×
MG7500 series	✓
MG7100 series	✓
MG6900 series	×
MG6800 series	×
MG6700 series	✓
MG6600 series	✓
MG6500 series	✓
MG6400 series	✓
MG5700 series	No card slot
MG5600 series	No card slot
MG5500 series	No card slot
MG3600 series	No card slot
MG3500 series	No card slot
MG2900 series	No card slot
MG2500 series	No card slot
MG2400 series	No card slot

**MX series / MB series / E series / P series / iP series / iX series / iB series /
PRO series / G series**

Model name	Using the card slot via a network
MX series	No card slot
MB series	No card slot
E series	No card slot
P series	No card slot
iP series	No card slot
iX series	No card slot
iB series	No card slot
PRO series	No card slot
G series	No card slot

Printing

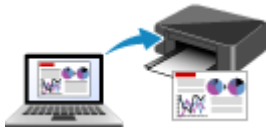

Printing from Computer

Printing from Computer

- ▶ **Printing from Application Software (Windows Printer Driver)**
- ▶ **Printing from Application Software (Mac OS Printer Driver)**
- ▶ **Printing Using Canon Application Software**

Printing from Application Software (Mac OS Printer Driver)

- ▶ **Printing with Easy Setup** 📌 **Basic**
- ▶ **Various Printing Methods**
- ▶ **Changing the Print Quality and Correcting Image Data**
- ▶ **Overview of the Printer Driver**
- ▶ **Updating the Printer Driver**
- ▶ **Sharing the Printer on a Network**

Printing with Easy Setup

The simple setup procedure for carrying out appropriate printing on this printer is as follows:

1. [Check that the printer is turned on](#)
2. [Load paper](#) on the printer
3. Select the printer

Select your model from the **Printer** list in the [Print Dialog](#).

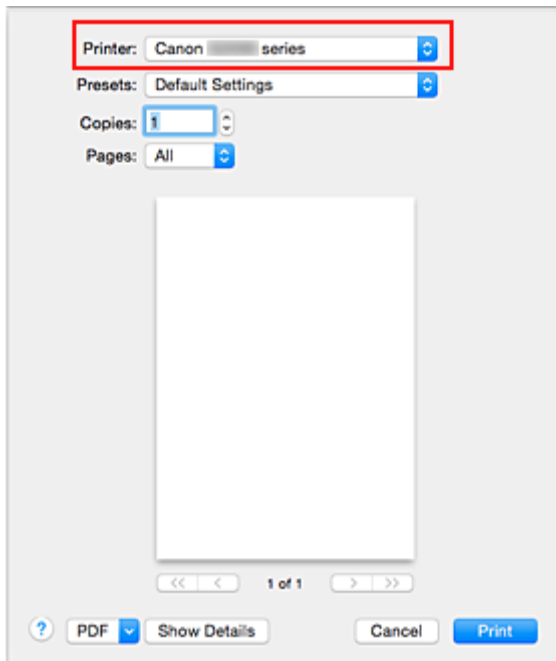

►►► Note

- Click **Show Details** to switch the Setup window to the detailed display.

4. Select the paper size

For **Paper Size**, select the paper size to be used.

If necessary, set the number of copies, the pages to be printed, and the orientation.

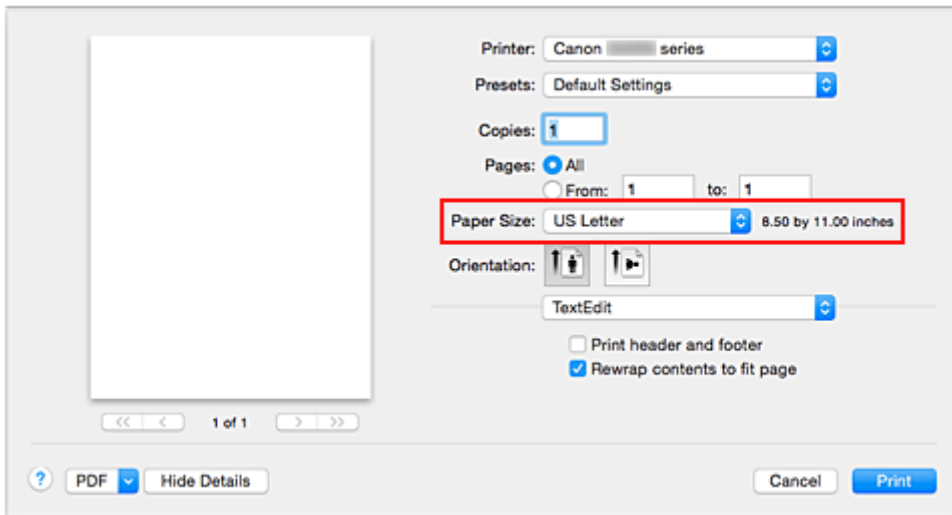

5. Select **Quality & Media** from the pop-up menu

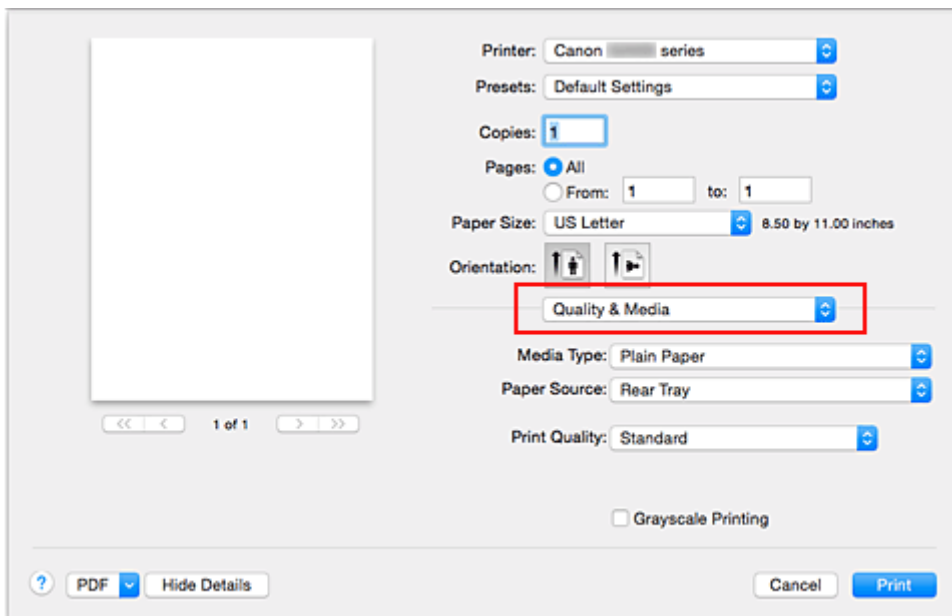

6. Select the media type

For **Media Type**, select the same paper type loaded in the printer.

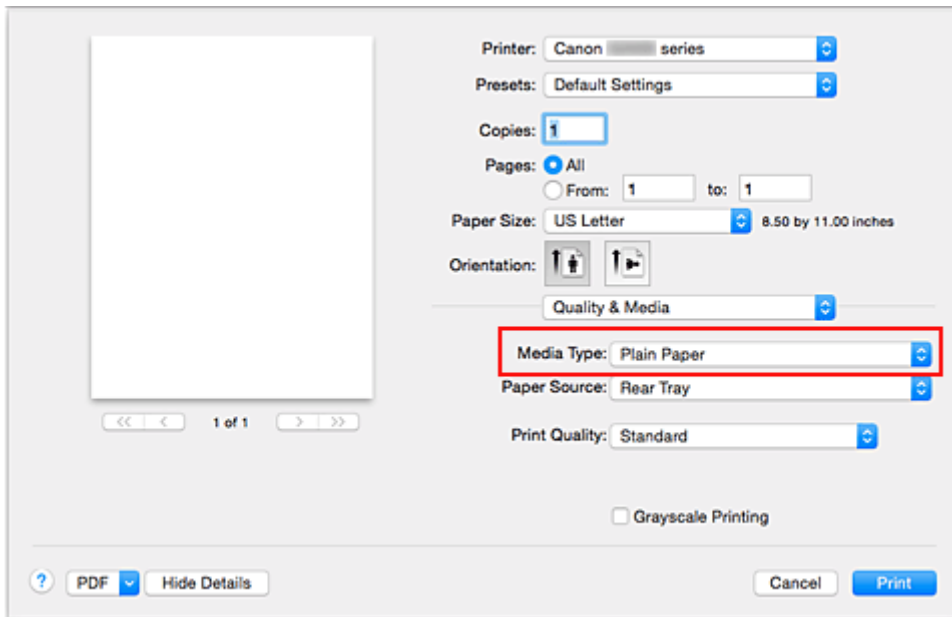

7. Select the print quality

For **Print Quality**, select **High**, **Standard**, or **Draft** according to your purpose.

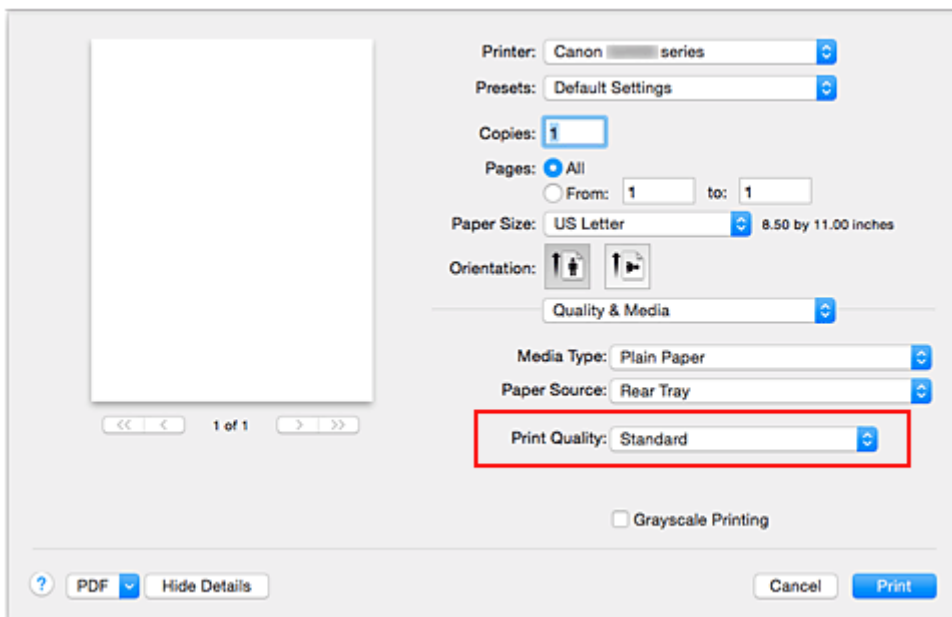

»»» Important

- The print quality settings that can be selected may differ depending on a printing profile.

8. Complete the setup

Click **Print**.

When you execute print, the document will be printed in accordance with the type and size of the media.

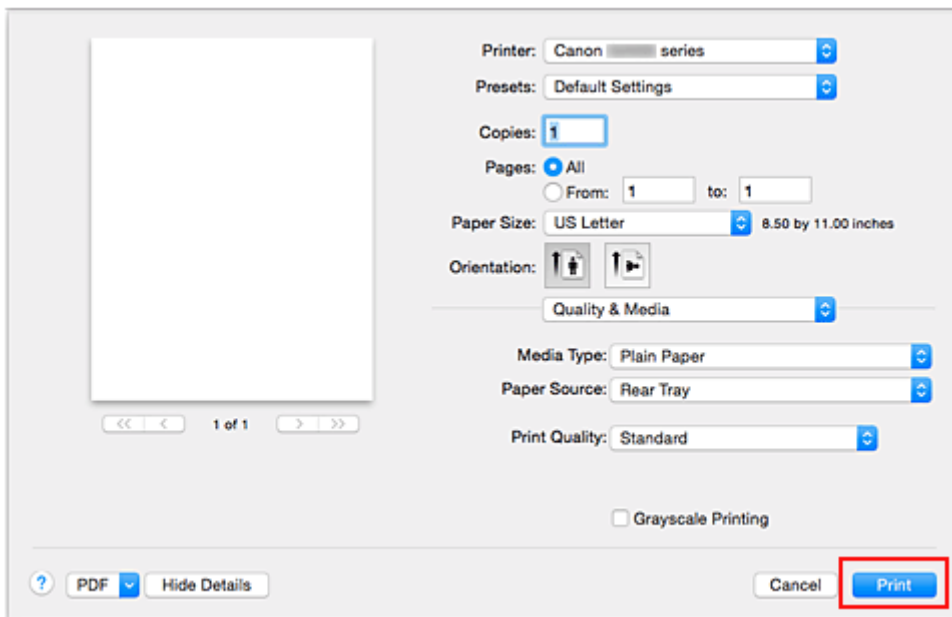

»» Important

- If you check the **Do not show again** check box when a guide message is displayed before printing starts, this will stop any more guide messages from being displayed.
- In the **Presets** section, click **Save Current Settings as Preset...** to [register the specified settings](#).

Paper Settings on the Printer Driver

When you use this printer, selecting a media type that matches the print purpose will help you achieve the best print results.

You can use the following media types on this printer.

Canon genuine papers (Document Printing)

Media name <Model No.>	Media Type in the printer driver
Canon Red Label Superior <WOP111>	Plain Paper
Canon Océ Office Colour Paper <SAT213>	Plain Paper

Canon genuine papers (Photo Printing)

Media name <Model No.>	Media Type in the printer driver
Photo Paper Pro Luster <LU-101>	Photo Paper Pro Luster
Photo Paper Plus Semi-gloss <SG-201>	Photo Paper Plus Semi-gloss
Photo Paper Glossy <GP-501/GP-601>	Glossy Photo Paper
Matte Photo Paper <MP-101>	Matte Photo Paper

Canon genuine papers (Business Letter Printing)

Media name <Model No.>	Media Type in the printer driver
High Resolution Paper <HR-101N>	High Resolution Paper

Canon genuine papers (Original Products)

Media name <Model No.>	Media Type in the printer driver
Photo Stickers <PS-101>	Glossy Photo Paper

Commercially available papers

Media name	Media Type in the printer driver
Plain Paper (including recycled paper)	Plain Paper
Envelopes	Envelope
Other Photo Paper	Other Photo Paper

Various Printing Methods

- **Setting the Number of Copies and Printing Order**
- **Setting the Stapling Margin**
- **Execute Borderless Printing**
- **Scaling the Printing to Fit the Paper Size**
- **Scaled Printing**
- **Page Layout Printing**
- **Setting Up Envelope Printing**
- **Setting Paper Dimensions (Custom Size)**

Setting the Number of Copies and Printing Order

Collate pages + Reverse Collate pages + Normal Reverse

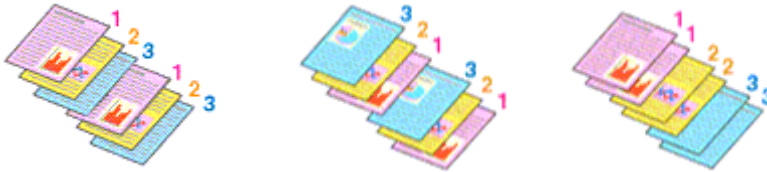

The procedure for specifying the number of copies and printing order is as follows:

1. Specify the number of copies to be printed

Specify the number of copies to print from the **Copies** in the [Print Dialog](#).

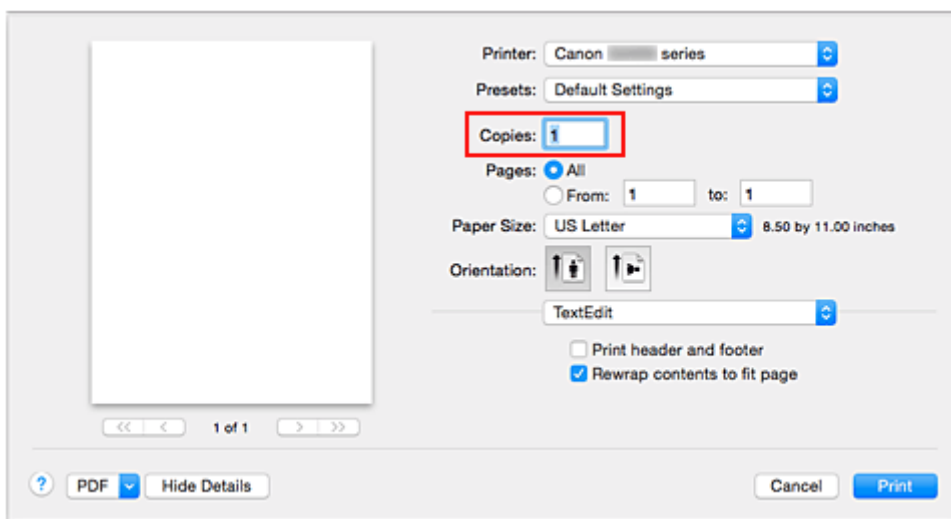

2. Select **Paper Handling** from the pop-up menu
3. Check the **Collate pages** check box when you are specifying multiple copies in the **Copies** box

Check the **Collate pages** check box to print all the pages of a single copy together.
Uncheck this check box to print all pages with the same page number together.

4. Specify the print order

Check **Page Order**.

When you select **Automatic** or **Reverse**, printing starts from the last page.
When you select **Normal**, printing starts from the first page.

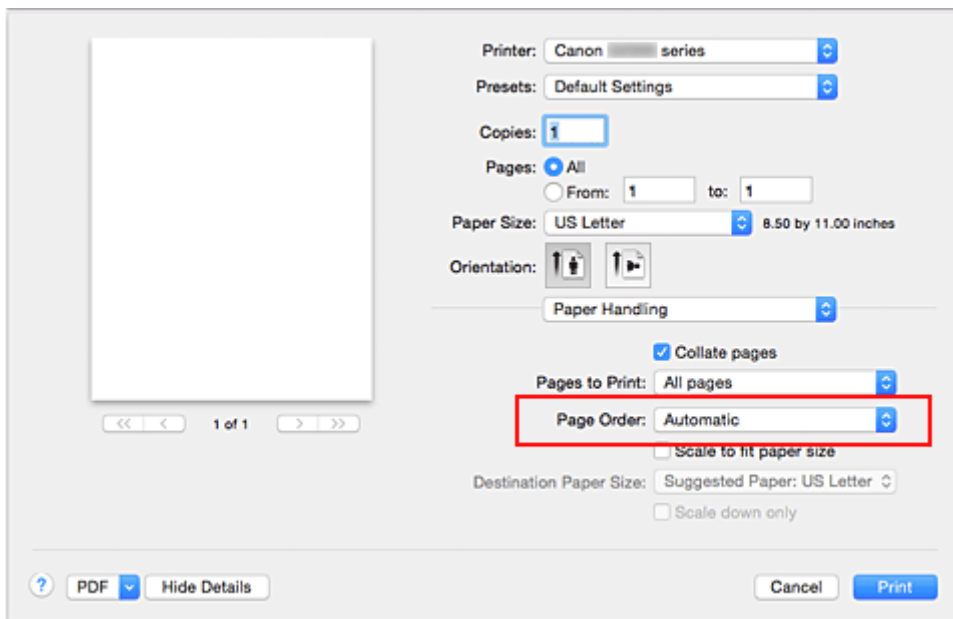

5. Complete the setup

Click **Print**.

When you execute print, the specified number of copies will be printed with the specified printing order.

»»» Important

- When the application software that you used to create the document has the same function, specify the settings on the printer driver. However, if the print results are not acceptable, specify the function settings on the application software. When you specify the number of copies and the printing order with both the application software and this printer driver, the number of copies may be multiplied numbers of the two settings or the specified printing order may not be enabled.

Setting the Stapling Margin



The procedure for setting the margin width and the staple side is as follows:

1. Select **Margin** from the pop-up menu on the [Print Dialog](#)

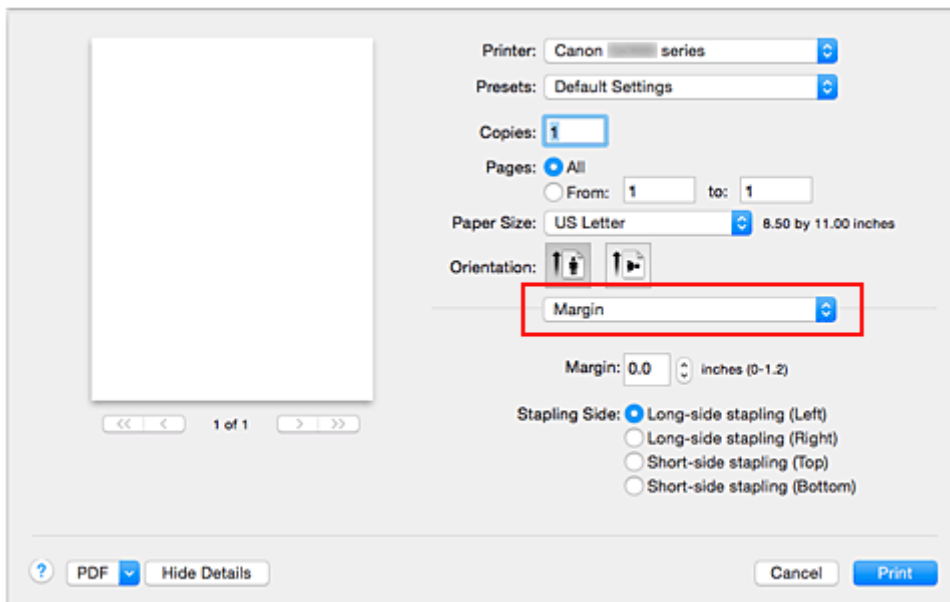

2. Set the margin width and the staple side

If necessary, set the **Margin** width, and select a stapling position from the **Stapling Side** list.

►►► Note

- The printer automatically reduces the print area depending on the staple position margin.

3. Complete the setup

Click **Print**.

When you execute print, the data is printed with the specified margin width and staple side.

►►► Important

- When borderless printing is enabled, **Margin** and **Stapling Side** appear grayed out and are unavailable.

Execute Borderless Printing

The borderless printing function allows you to print data without any margin by enlarging the data so that it extends slightly off the paper. In standard printing, margins are created around the document area. However, in borderless printing function, these margins are not created. When you want to print data such as a photo without providing any margin around it, set borderless printing.

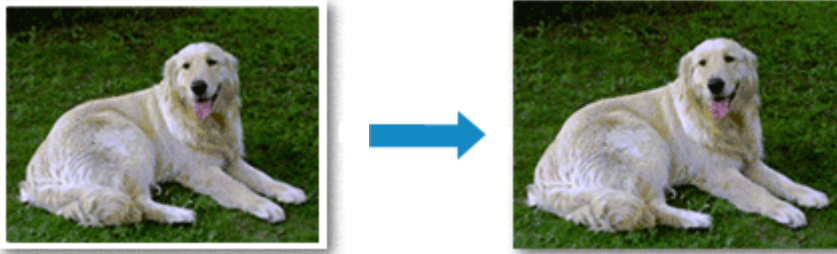

The procedure for performing borderless printing is as follows:

Setting Borderless Printing

1. Select the size of the paper for borderless printing

Select "XXX (borderless)" from the **Paper Size** in the [Print Dialog](#).

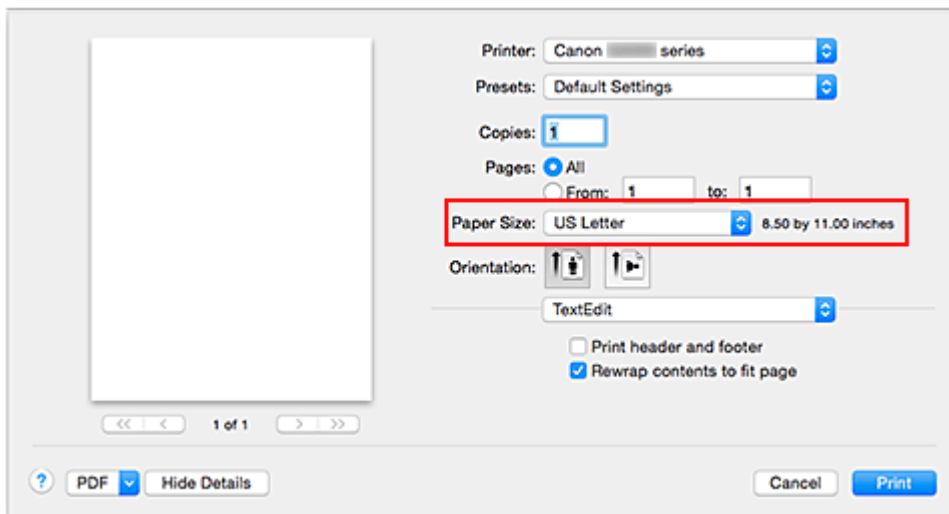

2. Select **Borderless Printing** from the pop-up menu

3. Adjust the amount of extension from the paper

If necessary, adjust the amount of extension using the **Amount of Extension** slider.

Moving the slider to the right increases the amount extending off the paper, and moving the slider to the left decreases the amount.

It is recommended to set the slider at the second position from the right for most cases.

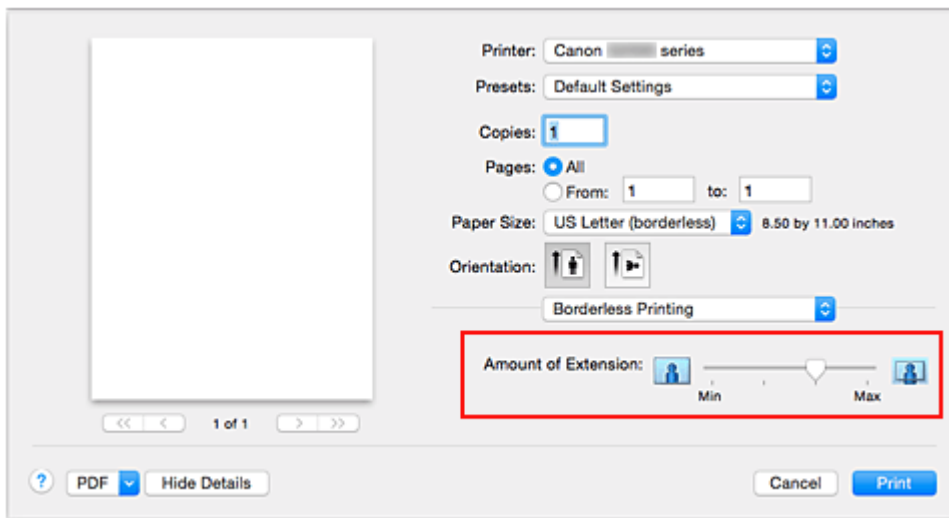

►►► Important

- When the **Amount of Extension** slider is set to the rightmost position, the back side of the paper may become smudged.

4. Complete the setup

Click **Print**.

When you execute print, the data is printed without any margins on the paper.

►►► Important

- Borderless printing only supports specific paper sizes. Make sure to select a paper size with the wording "(borderless)" from the **Paper Size**.
- When borderless printing is enabled, **Envelope**, and **High Resolution Paper** appear grayed out and are unavailable in **Media Type** list of **Quality & Media** of the pop-up menu in the Print dialog.
- Print quality may deteriorate or the sheet may be stained at the top and bottom depending on the type of paper used.
- When the ratio of the height to the width differs from the image data, a portion of the image may not be printed depending on the size of the media used.
In this case, crop the image data with an application software according to the paper size.
- When scaled printing or page layout printing is enabled, you cannot perform borderless printing.

►►► Note

- When **Plain Paper** is selected from the **Media Type** menu of the **Quality & Media**, borderless printing is not recommended.

Expanding the Range of the Document to Print

Setting a large amount of extension allows you to perform borderless printing with no problems. However, the portion of the document extending off the paper range will not be printed and for this reason, the subjects around the perimeter of a photo may not be printed.

When you are not satisfied with the result of borderless printing, reduce the amount of extension. The extension amount decreases as the **Amount of Extension** slider is moved to the left.

»» Important

- When the amount of extension is decreased, an unexpected margin may be produced on the print, depending on the size of the paper.

»» Note

- When the **Amount of Extension** slider is set to the leftmost position, image data will be printed in the full size.

Scaling the Printing to Fit the Paper Size



The procedure for printing a document that is automatically enlarged or reduced to fit the page size to be used is as follows:

1. Check the paper size

Check that the **Paper Size** in the [Print Dialog](#) is the same as the paper size that you set in the application software.

2. Select **Paper Handling** from the pop-up menu

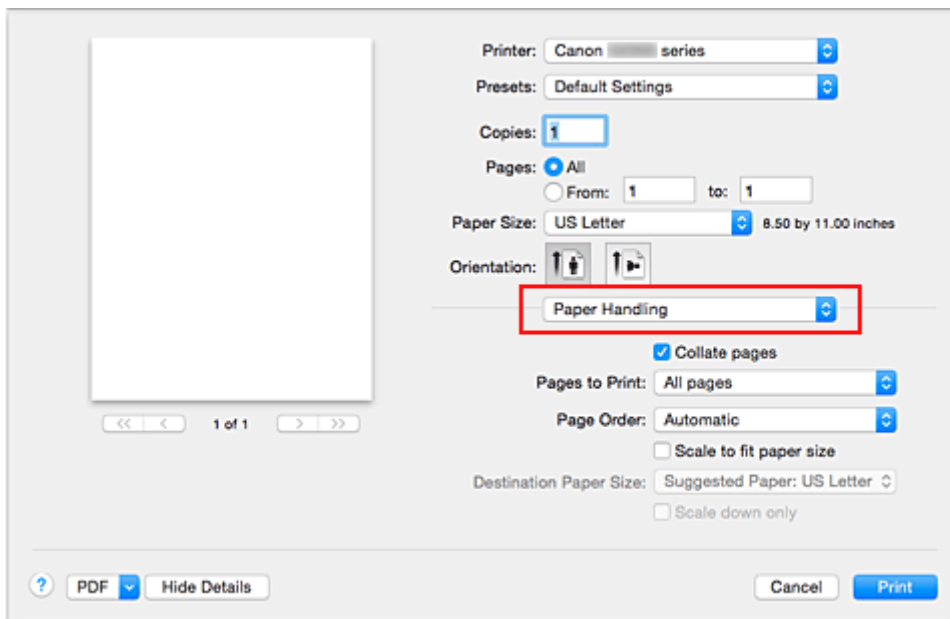

3. Set the print paper size

Check the **Scale to fit paper size** check box. Then from the **Destination Paper Size** pop-up menu, select the paper size that is actually loaded in the printer.

4. If necessary, check the **Scale down only** check box

When you check this check box, the document will be reduced to fit to the paper size when the document size is larger than the page size. The document will be printed in the original size when the document size is smaller than the page size.

5. Complete the setup

Click **Print**.

When you execute print, the document will be enlarged or reduced to fit to the page size.

Scaled Printing

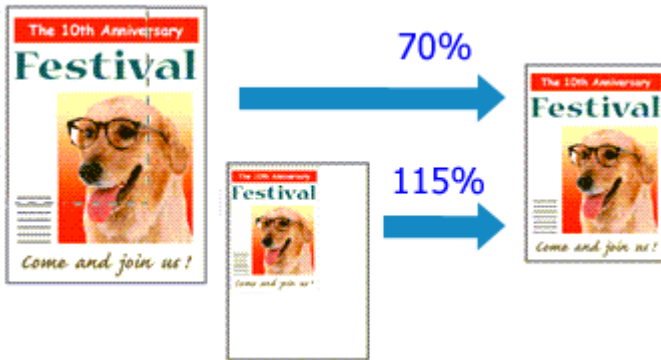

The procedure for printing a document with pages enlarged or reduced is as follows:

1. Select the printer

In the [Page Setup Dialog](#), select your model name from the **Format For** list.

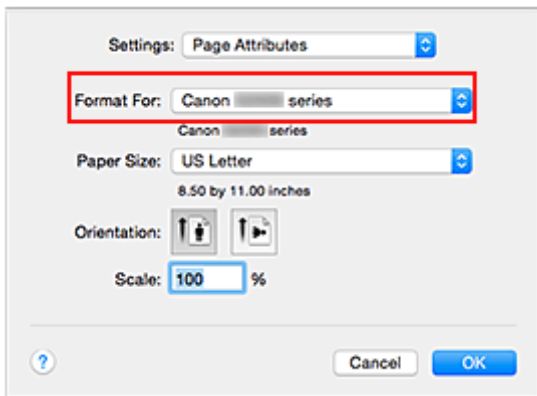

2. Set scaled printing

Specify the scaling factor in the **Scale** box, and click **OK**.

▶▶▶ Note

- Depending on the **Scale** value that you set, an error message may be displayed.

3. Complete the setup

On the [Print Dialog](#), click **Print**.

When you execute print, the document will be printed with the specified scale.

▶▶▶ Important

- When the application software which you used to create the original has the scaled printing function, configure the settings on your application software. You do not need to configure the same setting in the Page Setup dialog.

Page Layout Printing

The page layout printing function allows you to print more than one page image on a single sheet of paper.



The procedure for performing page layout printing is as follows:

1. Select **Layout** from the pop-up menu in the [Print Dialog](#)

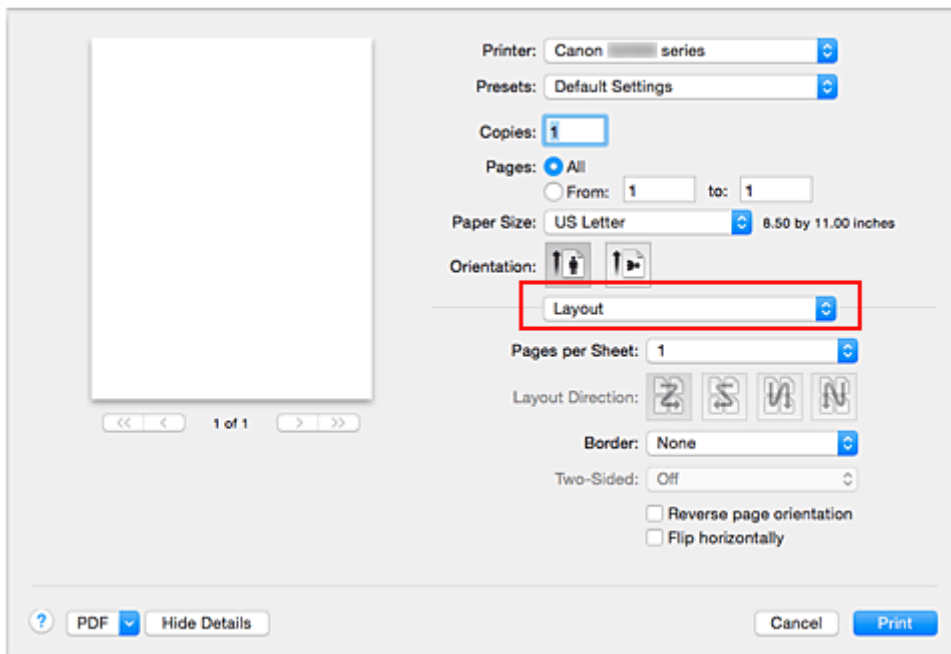

2. Set the number of original you print on one page

In **Pages per Sheet**, specify the number of page you print on one page.

3. If necessary, set the following items

Layout Direction

To change the page placement order, select an icon from the list.

Border

To print a page border around each document page, select a type of page border.

Reverse page orientation

Select this check box to change the paper orientation.

Flip horizontally

Select this check box to reverse left and right of the document.

4. Complete the setup

Click **Print**.

When you execute print, the specified number of pages will be arranged on each sheet of paper in the specified order.

Setting Up Envelope Printing

The procedure for performing envelope printing is as follows:

1. [Load envelope](#) into printer

2. Select paper size in [print dialog](#)

For Paper Size, select **Envelope #10**, **Envelope DL**, **Envelope You4**, or **Envelope You6**.

3. Set printing orientation

To print the addressee information horizontally, select Horizontal for **Orientation**. Then check the **Reverse page orientation** from the **Layout** pop-up menu in the Print dialogue.

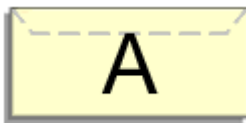

4. From pop-up menu, select **Quality & Media**

5. Select media type

For **Media Type**, select **Envelope**.

6. Select print quality

For **Print Quality**, select **High** or **Standard**, whichever matches your purpose.

7. Complete settings

Click **Print**.

When you execute printing, the information is printed on the envelope.

»» Important

- When printing on an envelope, always select the print settings from the print dialog.

Setting Paper Dimensions (Custom Size)

You can specify the height and width of paper when its size cannot be selected from the **Paper Size** menu. Such a paper size is called "custom size."

The procedure for specifying a custom size is as follows:

1. Creating a new custom paper size

In the [Print Dialog](#), select **Manage Custom Sizes...** from **Paper Size**.

In the displayed dialog, click **+**.

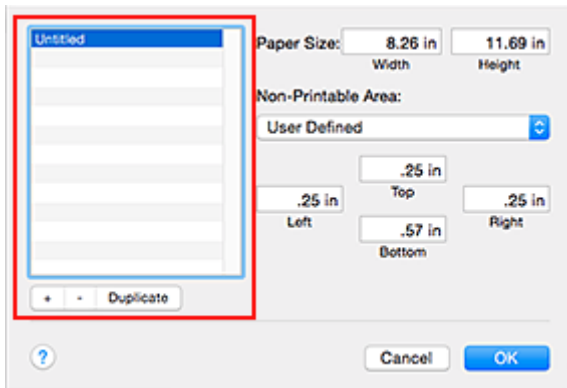

Untitled will be added to the list.

2. Setting details about the custom paper size

Double-click **Untitled**, enter the name of the paper size you want to register, and specify the **Width** and **Height** of the paper for **Paper Size**.

Select **User Defined** or your model for **Non-Printable Area**, and enter the margins.

3. Registering the custom paper size

Click **OK**.

The custom size is registered.

»»» Important

- If the application software that created the document has a function for specifying height and width values, use the application software to set the values. If the application software does not have such a function or if the document does not print correctly, perform the above procedure from the printer driver to set the values.

»»» Note

- To duplicate the registered paper size, select the paper size that you want to duplicate from the **Custom Paper Sizes** list, and click **Duplicate**.
- To delete a registered paper size, select the paper size that you want to delete from the **Custom Paper Sizes** list, and click **-**.

Changing the Print Quality and Correcting Image Data

- ▶ **Setting the Print Quality Level (Custom)**
- ▶ **Printing a Color Document in Monochrome**
- ▶ **Specifying Color Correction**
- ▶ **Optimal Photo Printing of Image Data**
- ▶ **Adjusting Colors with the Printer Driver**
- ▶ **Printing with ICC Profiles (Specifying an ICC Profile from the Application Software)**
- ▶ **Printing with ICC Profiles (Specifying an ICC Profile from the Printer Driver)**
- ▶ **Adjusting Color Balance**
- ▶ **Adjusting Brightness**
- ▶ **Adjusting Intensity**
- ▶ **Adjusting Contrast**

Setting the Print Quality Level (Custom)

The print quality level can be set in the **Custom**.

The procedure for setting the print quality level is as follows:

1. Select **Quality & Media** from the pop-up menu on the [Print Dialog](#)
2. Select the print quality

Select **Custom** for **Print Quality**.

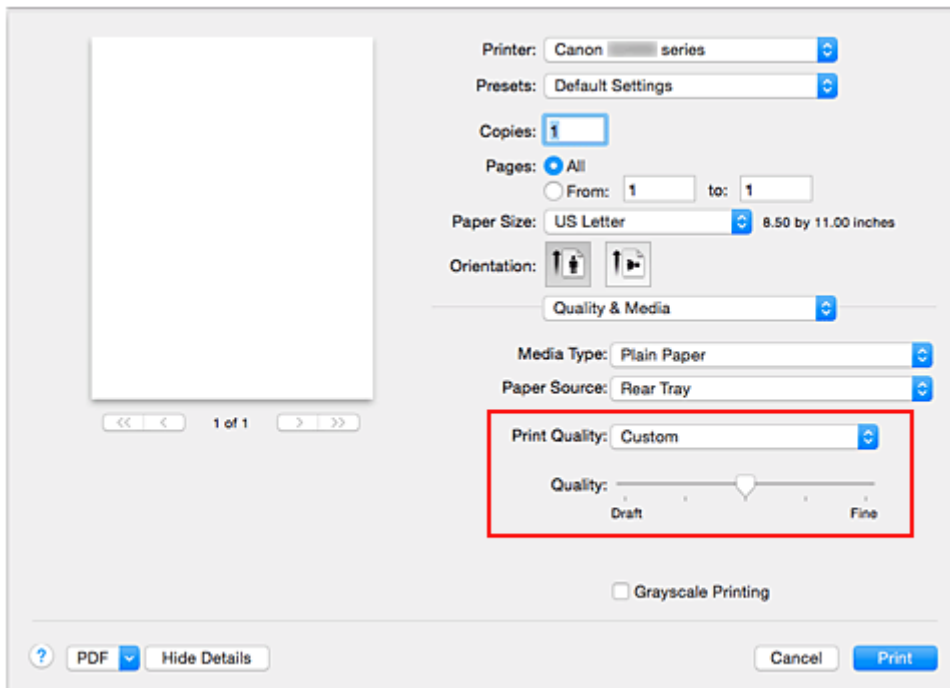

3. Setting the print quality level

Move the **Quality** slider to select the print quality level.

4. Complete the setup

Click **Print**.

When you execute print, the image data is printed with the selected print quality level.

►►► Important

- Certain print quality levels cannot be selected depending on the settings of **Media Type**.

Related Topics

- [Specifying Color Correction](#)
- [Adjusting Color Balance](#)
- [Adjusting Brightness](#)
- [Adjusting Intensity](#)
- [Adjusting Contrast](#)

Printing a Color Document in Monochrome

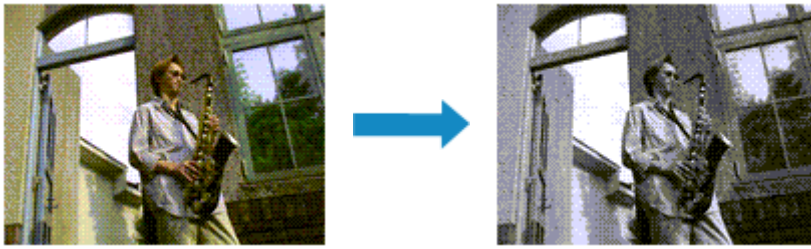

The procedure for printing a color document in monochrome is as follows:

1. Select **Quality & Media** from the pop-up menu on the [Print Dialog](#)
2. Set grayscale printing

Check the **Grayscale Printing** check box.

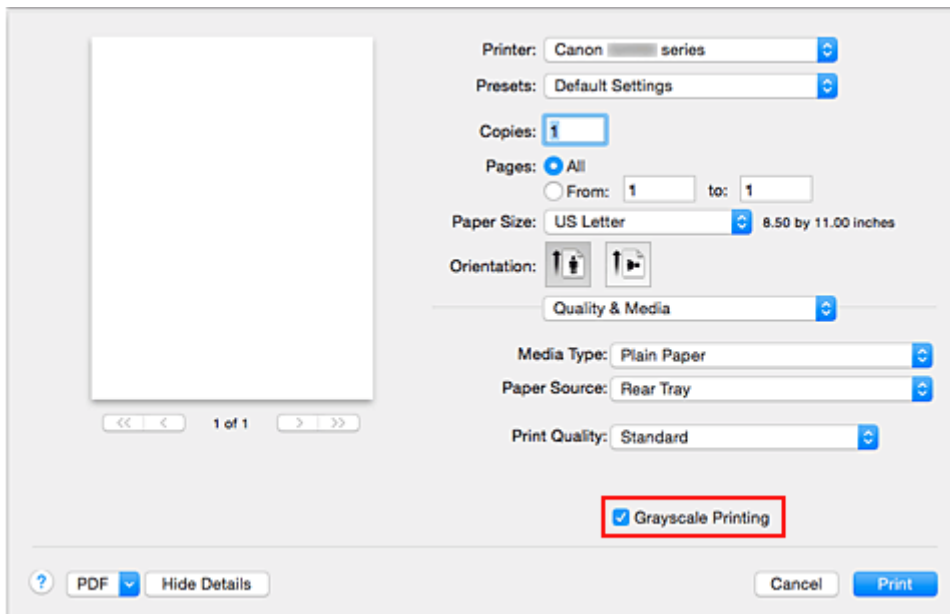

3. Complete the setup

Click **Print**.

When you execute print, the document is converted to grayscale data. It allows you to print the color document in monochrome.

►►► Note

- During **Grayscale Printing**, inks other than black ink may be used as well.

Specifying Color Correction

You can specify the color correction method suited to the type of document to be printed.

Normally, the printer driver adjusts the colors by using Canon Digital Photo Color so that data is printed with color tints that most people prefer.

When you want to print by using the color space (sRGB) of the image data effectively or by specifying a printing ICC profile from your application software, select **ColorSync**. When you want to print by having the printer driver correct the colors, select **Canon Color Matching**.

The procedure for specifying color correction is as follows:

1. Select **Color Matching** from the pop-up menu of the [Print Dialog](#)

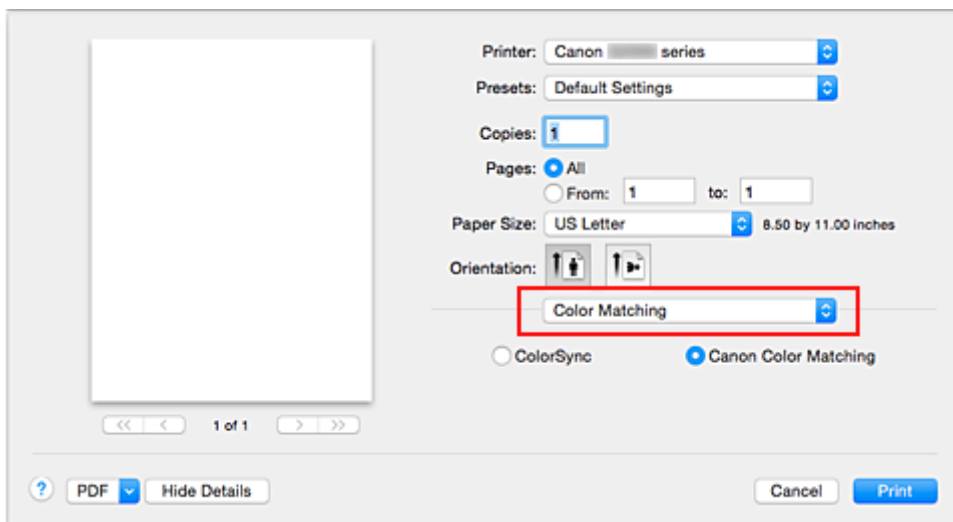

2. Select color correction

Select the item below that matches your purpose.

ColorSync

Perform color correction using ColorSync.

Canon Color Matching

With Canon Digital Photo Color, you can print with color tints that most people prefer.

3. Complete the setup

Click **Print**.

When you execute print, the document data is printed with the specified color correction.

▶▶▶ Important

- Depending on the application software, when a printing ICC profile is specified from that application software, **Canon Color Matching** cannot be selected because **ColorSync** is selected automatically.
- The **Quality & Media** setting is necessary even when **ColorSync** or **Canon Color Matching** is selected.

Related Topics

- [Optimal Photo Printing of Image Data](#)
- [Adjusting Colors with the Printer Driver](#)
- [Printing with ICC Profiles \(Specifying an ICC Profile from the Application Software\)](#)
- [Printing with ICC Profiles \(Specifying an ICC Profile from the Printer Driver\)](#)

Optimal Photo Printing of Image Data

When people print images taken with digital cameras, they sometimes feel that the printed color tones differ from those of actual image or those displayed on the monitor.

To get the print results as close as possible to the desired color tones, you must select a printing method that is best suited to the application software used or to your purpose.

Color Management

Devices such as digital cameras, scanners, monitors, and printers handle color differently. Color management (color matching) is a method that manages device-dependent "colors" as a common color space.

For Mac OS, a color management system called "ColorSync" is built into the operating system. sRGB is one of the common color spaces that is frequently used.

ICC profiles convert device-dependent "colors" into a common color space. By using an ICC profile and carrying out color management, you can draw out the color space of the image data within the color reproduction area that the printer can express.

Selecting a Printing Method Suited to the Image Data

The recommended printing method depends on the color space (sRGB) of the image data or the application software to be used.

There are two typical printing methods.

Check the color space (sRGB) of the image data and the application software to be used, and then select the printing method suited to your purpose.

Adjusting Colors with the Printer Driver

Describes the procedure for printing by using the color correction function of the printer driver.

- To print using Canon Digital Photo Color

The printer prints data with color tints that most people prefer, reproducing colors of the original image data and producing three-dimensional effects and high, sharp contrasts.

- To print by directly applying editing and touch-up results of an application software

When printing the data, the printer brings out subtle color difference between dark and light areas, while leaving the darkest and lightest areas intact.

When printing the data, the printer applies fine adjustment results, such as brightness adjustments made with an application software.

Printing with ICC Profiles (Specifying an ICC Profile from the Application Software)

Describes the procedure for printing by using the color space of sRGB effectively.

You can print with a common color space by setting up the application software and the printer driver so that the color management matches the input ICC profile of the image data.

The method for setting up the printer driver differs depending on the application software to be used.

Adjusting Colors with the Printer Driver

You can specify the color correction function of the printer driver to print with color tints that most people prefer through the use of Canon Digital Photo Color.

When printing from an application software that can identify ICC profiles and allows you to specify them, use a printing ICC profile in the application software, and select settings for color management.

The procedure for adjusting colors with the printer driver is as follows:

1. Select **Color Matching** from the pop-up menu of the [Print Dialog](#)

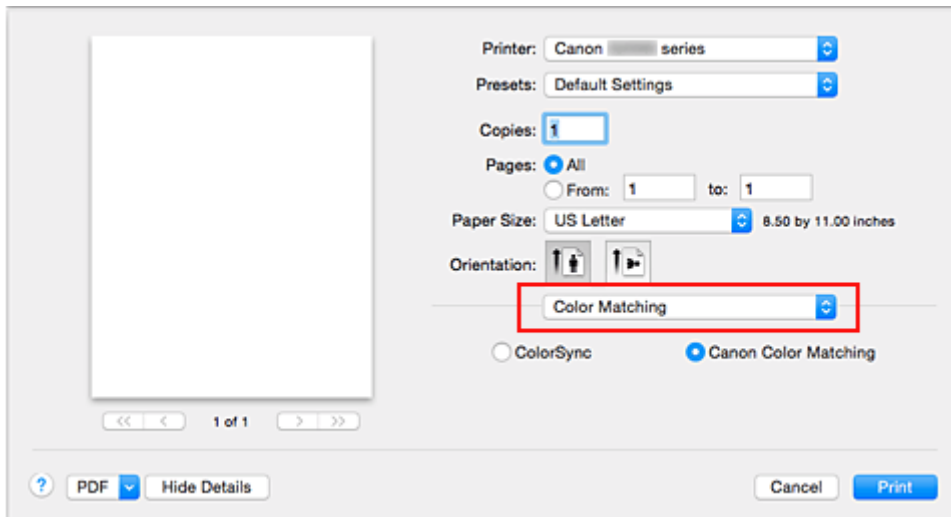

2. Select color correction

Select **Canon Color Matching**.

3. Set the other items

From the pop-up menu, select **Color Options**. If necessary, adjust the color balance (**Cyan, Magenta, Yellow**) and adjust **Brightness, Intensity, and Contrast** settings.

4. Complete the setup

Click **Print**.

When you execute print, the printer driver adjusts the colors when printing the data.

Related Topics

- [Setting the Print Quality Level \(Custom\)](#)
- [Specifying Color Correction](#)
- [Adjusting Color Balance](#)
- [Adjusting Brightness](#)
- [Adjusting Intensity](#)
- [Adjusting Contrast](#)

Printing with ICC Profiles (Specifying an ICC Profile from the Application Software)

When you print from Adobe Photoshop, Canon Digital Photo Professional, or any application software that can identify input ICC profiles and allows you to specify such profiles, printer uses the color management system (ColorSync) built-into Mac OS when printing. The printer prints the editing and touch-up results of the application software and effectively uses the color space of the input ICC profile specified in the image data.

To use this printing method, use your application software to select color management items and specify an input ICC profile and a printing ICC profile in the image data.

Even if you print using a printing ICC profile that you created yourself from your application software, be sure to select color management items from your application software.

For instructions, refer to the manual of the application software you are using.

1. Select **Color Matching** from the pop-up menu of the [Print Dialog](#)

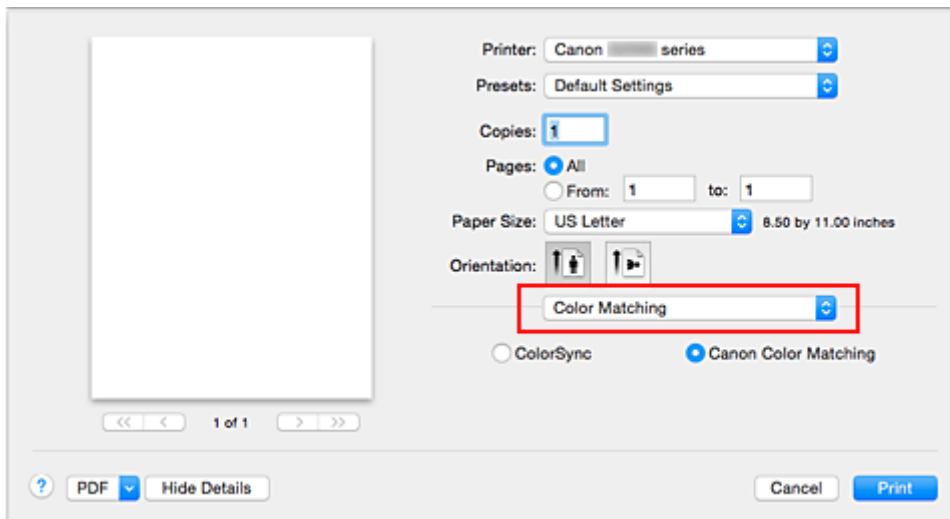

2. Select color correction

Select **ColorSync**.

You can leave **Profile** set to **Automatic**.

►►► Important

- Depending on the application software you use, you may not be able to select setting items other than **ColorSync**.
- If you choose a **Profile** setting other than **Automatic**, the printer will not be able to print with the correct colors.

3. Complete the setup

Click **Print**.

When you execute print, the printer uses the color space of the image data.

Related Topics

- [Setting the Print Quality Level \(Custom\)](#)

- [Specifying Color Correction](#)
- [Adjusting Color Balance](#)
- [Adjusting Brightness](#)
- [Adjusting Intensity](#)
- [Adjusting Contrast](#)

Printing with ICC Profiles (Specifying an ICC Profile from the Printer Driver)

Print from an application software that cannot identify or specify input ICC profiles by using the color space of the input ICC profile (sRGB) found in the data.

1. Select **Color Matching** from the pop-up menu of the [Print Dialog](#)

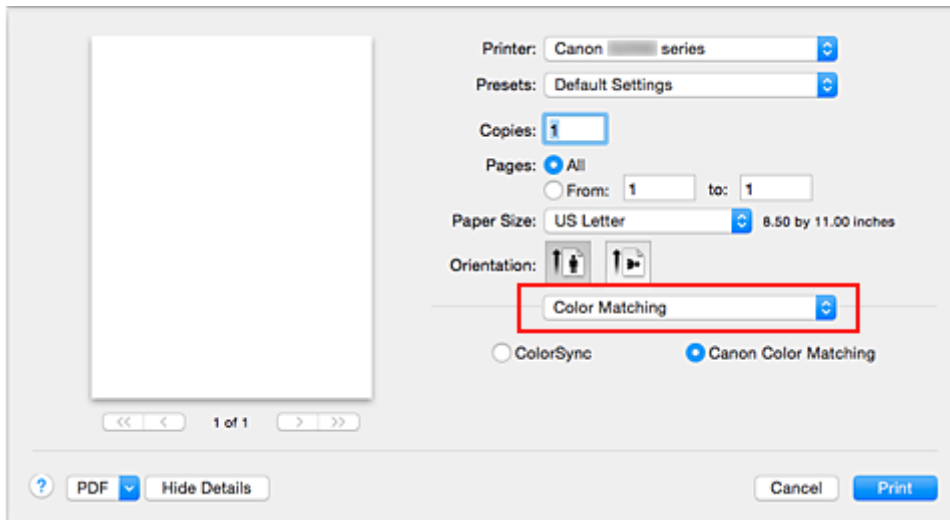

2. Select color correction

Select **ColorSync**.

You can leave **Profile** set to **Automatic**.

»»» Important

- If you choose a **Profile** setting other than **Automatic**, the printer will not be able to print with the correct colors.

3. Complete the setup

Click **Print**.

When you execute print, the printer uses the color space of the image data.

»»» Important

- You cannot specify an input ICC profile from the printer driver.

Related Topics

- [Setting the Print Quality Level \(Custom\)](#)
- [Specifying Color Correction](#)
- [Adjusting Color Balance](#)
- [Adjusting Brightness](#)
- [Adjusting Intensity](#)
- [Adjusting Contrast](#)

Adjusting Color Balance

You can adjust the color tints when printing.

Since this function adjusts color balance of the output by changing the ink ratios of each color, it changes the total color balance of the document. Use the application software when you want to change the color balance significantly. Use the printer driver only when you want to adjust the color balance slightly.

The following sample shows the case when color balance is used to intensify cyan and to diminish yellow so that the overall colors are more uniform.



No adjustment Adjust color balance

The procedure for adjusting color balance is as follows:

1. Select **Color Options** from the pop-up menu of the [Print Dialog](#)
2. Adjust color balance

There are individual sliders for **Cyan**, **Magenta**, and **Yellow**. Each color becomes stronger when the corresponding slider is moved to the right, and becomes weaker when the corresponding slider is moved to the left. For example, when cyan becomes weaker, the color red becomes stronger.

You can also directly enter a value linked to the slider. Enter a value in the range from -50 to 50. The current settings are displayed in the settings preview on the left side of the printer driver.

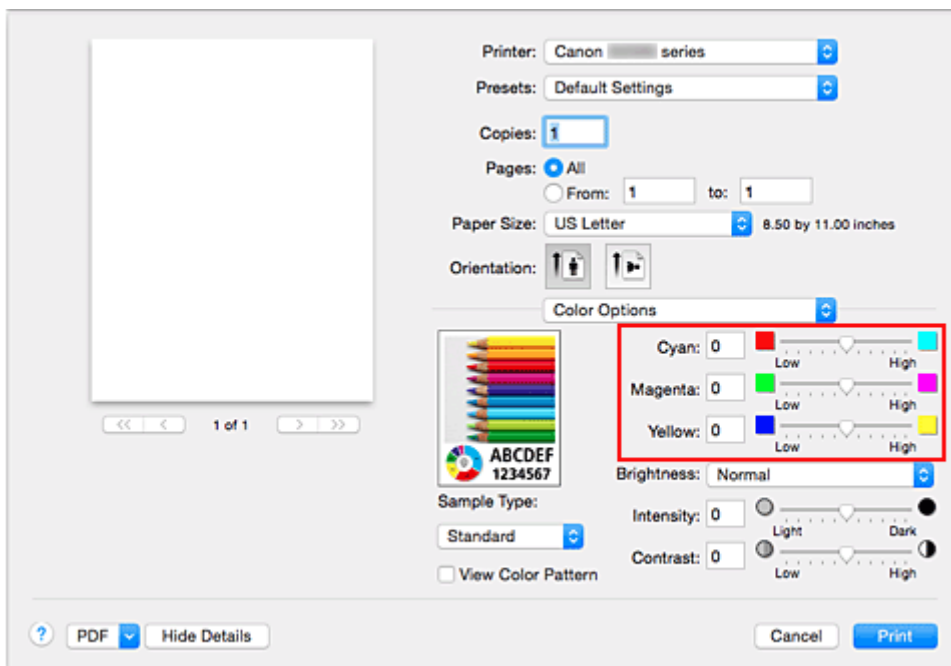

3. Complete the setup

Click **Print**.

When you execute print, the document is printed with the adjusted color balance.

»» Important

- When the **Grayscale Printing** check box is checked for **Quality & Media**, the color balance (**Cyan, Magenta, Yellow**) appear grayed out and are unavailable.
- If you select **ColorSync** for **Color Matching**, then the color balance (**Cyan, Magenta, Yellow**) appear grayed out and are unavailable.

Related Topics

- [Setting the Print Quality Level \(Custom\)](#)
- [Specifying Color Correction](#)
- [Adjusting Brightness](#)
- [Adjusting Intensity](#)
- [Adjusting Contrast](#)

Adjusting Brightness

You can change the brightness of the overall image data during printing.

This function does not change pure white or pure black but it changes the brightness of the intermediate colors.

The following sample shows the print result when the brightness setting is changed.



Light is selected

Normal is selected

Dark is selected

The procedure for adjusting brightness is as follows:

1. Select **Color Options** from the pop-up menu of the [Print Dialog](#)
2. Specify the brightness

Select **Light**, **Normal**, or **Dark** for **Brightness**. The current settings are displayed in the settings preview on the left side of the printer driver.

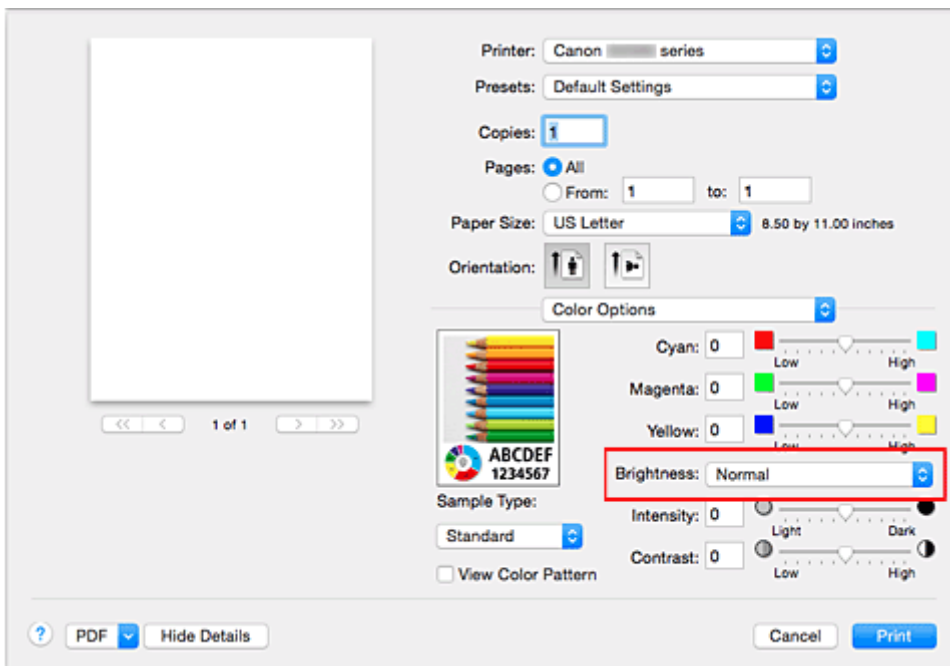

3. Complete the setup

Click **Print**.

When you execute print, the data is printed at the specified brightness.

»» Important

- If you select **ColorSync** for **Color Matching**, then the **Brightness** appears grayed out and is unavailable.

Related Topics

- [Setting the Print Quality Level \(Custom\)](#)
- [Specifying Color Correction](#)
- [Adjusting Color Balance](#)
- [Adjusting Intensity](#)
- [Adjusting Contrast](#)

Adjusting Intensity

You can dilute (brighten) or intensify (darken) the colors of the overall image data during printing. The following sample shows the case when the intensity is increased so that all colors become more intense when the image data is printed.



No adjustment

Higher intensity

The procedure for adjusting intensity is as follows:

1. Select **Color Options** from the pop-up menu of the [Print Dialog](#)
2. Adjust intensity

Moving the **Intensity** slider to the right intensifies (darkens) the colors, and moving the slider to the left dilutes (brightens) the colors.

You can also directly enter a value linked to the slider. Enter a value in the range from -50 to 50. The current settings are displayed in the settings preview on the left side of the printer driver.

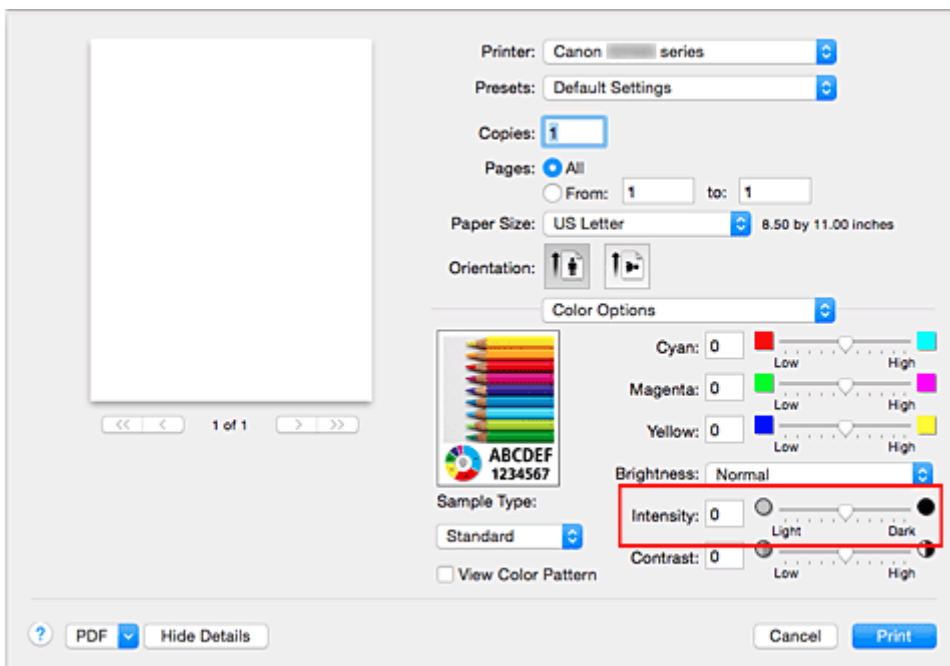

3. Complete the setup

Click **Print**.

When you execute print, the image data is printed with the adjusted intensity.

►► Important

- If you select **ColorSync** for **Color Matching**, then the **Intensity** appears grayed out and is unavailable.

Related Topics

- [Setting the Print Quality Level \(Custom\)](#)
- [Specifying Color Correction](#)
- [Adjusting Color Balance](#)
- [Adjusting Brightness](#)
- [Adjusting Contrast](#)

Adjusting Contrast

You can adjust the image contrast during printing.

To make the differences between the light and dark portions of images greater and more distinct, increase the contrast. On the other hand, to make the differences between the light and dark portions of images smaller and less distinct, reduce the contrast.



No adjustment

Adjust the contrast

The procedure for adjusting contrast is as follows:

1. Select **Color Options** from the pop-up menu of the [Print Dialog](#)
2. Adjust the contrast

Moving the **Contrast** slider to the right increases the contrast, and moving the slider to the left decreases the contrast.

You can also directly enter a value linked to the slider. Enter a value in the range from -50 to 50. The current settings are displayed in the settings preview on the left side of the printer driver.

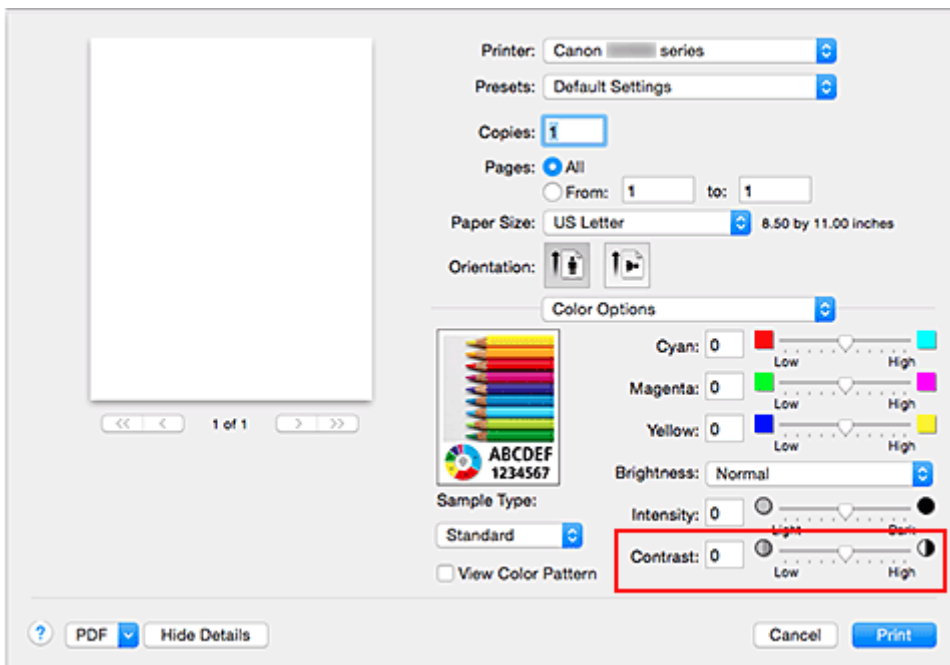

3. Complete the setup

Click **Print**.

When you execute print, the image is printed with the adjusted contrast.

▶▶ Important

- If you select **ColorSync** for **Color Matching**, then the **Contrast** appears grayed out and is unavailable.

Related Topics

- [Setting the Print Quality Level \(Custom\)](#)
- [Specifying Color Correction](#)
- [Adjusting Color Balance](#)
- [Adjusting Brightness](#)
- [Adjusting Intensity](#)

Overview of the Printer Driver

- ▶ **Canon IJ Printer Driver**
- ▶ **How to Open the Printer Driver Setup Window**
- ▶ **Page Setup Dialog**
- ▶ **Print Dialog**
- ▶ **Quality & Media**
- ▶ **Color Options**
- ▶ **Borderless Printing**
- ▶ **Margin**
- ▶ **Canon IJ Printer Utility**
- ▶ **Opening the Canon IJ Printer Utility**
- ▶ **Maintenance of this Printer**
- ▶ **Display the Printing Status Screen**
- ▶ **Deleting the Undesired Print Job**
- ▶ **Instructions for Use (Printer Driver)**

Canon IJ Printer Driver

The Canon IJ printer driver (called printer driver below) is a software that is installed on your computer for printing data with this printer.

The printer driver converts the print data created by your application software into data that your printer can understand, and sends the converted data to the printer.

Because different models support different print data formats, you need a printer driver for the specific model you are using.

Using Help of the Printer Driver

You can display Help function from the [Print Dialog](#).

Select a setup item from the pop-up menu in the Print dialog. Then click  at the bottom left of the screen to display an explanation of the item.

Help for the printer driver is displayed when the following pop-up menu item is selected:

- **Quality & Media**
- **Color Options**
- **Borderless Printing**
- **Margin**

How to Open the Printer Driver Setup Window

You can display the printer driver setup window from the application software you are using.

Opening the Page Setup Dialog

Use this procedure to set the page (paper) settings before printing.

1. Select **Page Setup...** from the **File** menu of the application software

The [Page Setup Dialog](#) opens.

Opening the Print Dialog

Use this procedure to set the print settings before printing.

1. Select **Print...** from the **File** menu of the application software

The [Print Dialog](#) opens.

Page Setup Dialog

In the Page Setup dialog, you configure the basic print settings such as the size of paper loaded in the printer or the scaling ratio.

To open the Page Setup dialog, you typically select **Page Setup...** from the **File** menu of your application software.

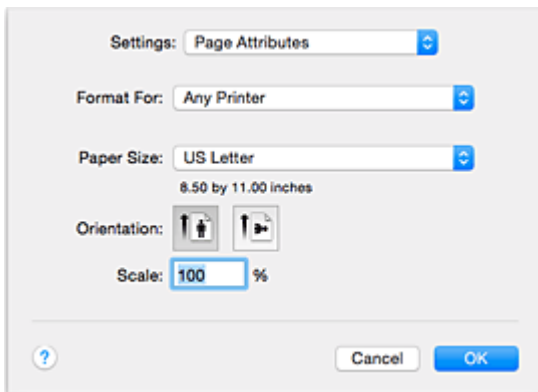

Settings

Click the pop-up menu, and then select the following items:

Page Attributes

Set the paper size or scaled printing.

Save as Default

You can save the attributes of the displayed page as the default settings.

»» Important

- If you are using OS X El Capitan v10.11, you cannot use **Save as Default**.

Format For

Select the model to be used for printing.

Paper Size

Select the size of the paper to be used for printing.

To set a non-standard size, select **Manage Custom Sizes....**

Orientation

Select the print orientation.

Scale

Set the scaling percentage.

You can expand or reduce the size of the document when printing.

Print Dialog

In the Print dialog, you can set paper type and print quality to start printing.

To open the Print dialog, you typically select **Print...** from the **File** menu of your application software.

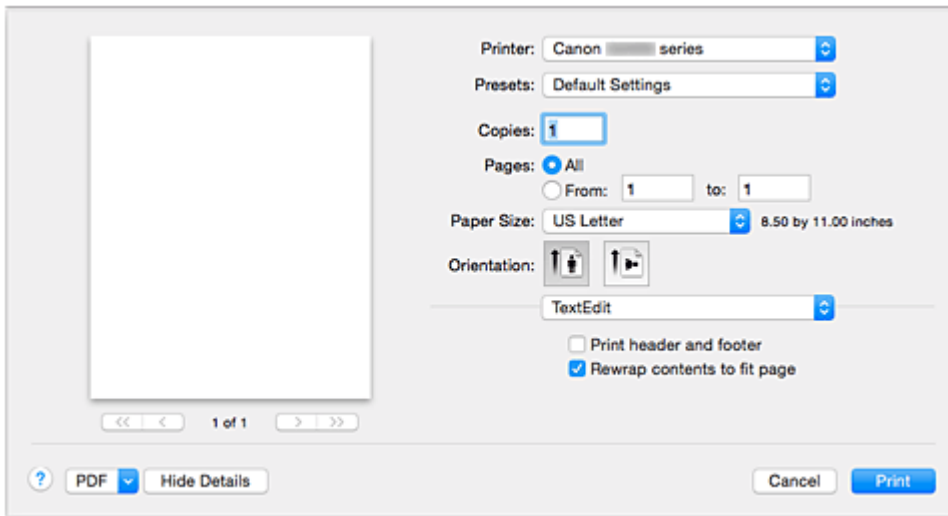

Printer

Select the model to be used for printing.

When you click **Add Printer...**, a dialog for specifying the printer opens.

Presets

You can save or delete the settings of the Print dialog.

►► Note

- You can select **Show Presets...** to check the print settings that are set in the Print dialog.

Copies

You can set the number of copies to be printed.

►► Note

- You can set collated printing by choosing **Paper Handling** from the pop-up menu.

Pages

You can set the range of pages to be printed.

Paper Size

Select the size of the paper to be used for printing.

To set a non-standard size, select **Manage Custom Sizes...**

Orientation

Select the print orientation.

Pop-up Menu

You can switch between pages in the Print dialog by the pop-up menu. The first menu to appear differs depending on the application software that opened the Print dialog.

You can choose one of the following items from the pop-up menu.

Layout

You can set page layout printing.

Use **Reverse page orientation** to change the paper orientation, and use **Flip horizontally** to print a mirror image of the document.

Color Matching

You can select the color correction method.

Paper Handling

You can set the pages to be printed on paper and the print order.

Cover Page

You can output cover pages both before and after a document.

Quality & Media

You can set basic print settings that match the printer.

Color Options

You can adjust the print colors as you desire.

Borderless Printing

You can adjust the amount of document that extends off the paper when performing borderless printing.

Margin

You can set the stapling side and the stapling margin.

PDF

You can save a document in PDF (Portable Document Format) format.

Quality & Media

This dialog allows you to create a basic print setup in accordance with the paper type. Unless special printing is required, normal printing can be performed just by setting the items in this dialog.

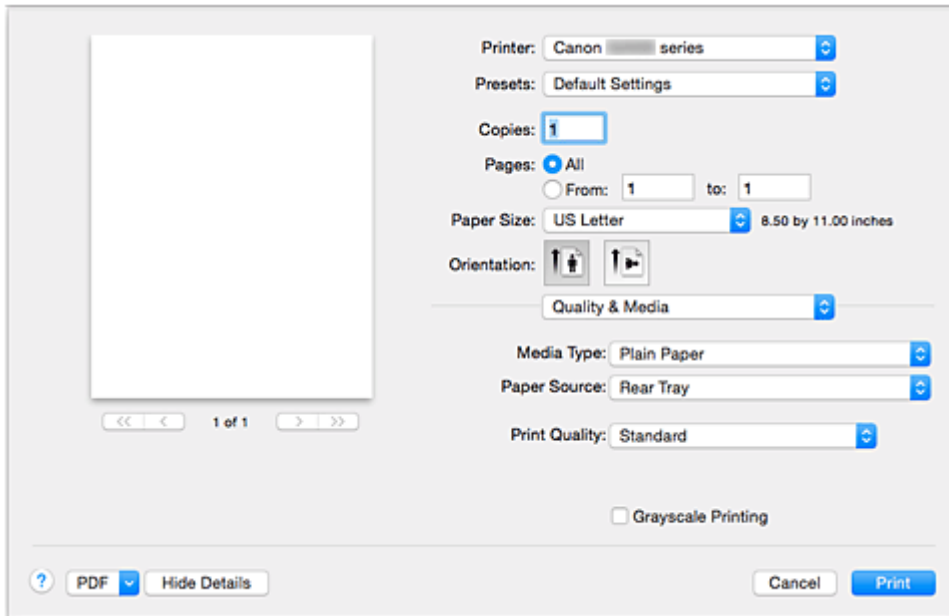

Media Type

Select the type of media to be used.

You must select the type of media actually loaded in the printer. This selection enables the printer to carry out printing properly for the material of the media used.

Paper Source

Shows the source from which paper is supplied.

Print Quality

Select the one that is closest to the original document type and the purpose.

When one of the radio buttons is selected, the appropriate quality will be set automatically.

High

Gives priority to print quality over printing speed.

Standard

Prints with average speed and quality.

Draft

This setting is appropriate for test printing.

Custom

Select this radio button to specify a quality.

Quality

When you select **Custom** in **Print Quality**, you can use the slider bar to adjust the print quality level.

Grayscale Printing

Set grayscale printing. Grayscale printing refers to the function of converting your document to grayscale data in the printer to print it in monochrome.

When you check the check box, both monochrome and color documents will be printed in monochrome.
When printing a color document, be sure to uncheck the check box.

Related Topics

- [Setting the Print Quality Level \(Custom\)](#)
- [Printing a Color Document in Monochrome](#)

Color Options

This dialog allows you to adjust the print color as you like. If the color of the printed image is not as expected, adjust the properties in the dialog and retry printing.

The adjustments made here do not affect the colors of the original print data unlike application software dedicated to image processing. Use this dialog just to make fine adjustments.

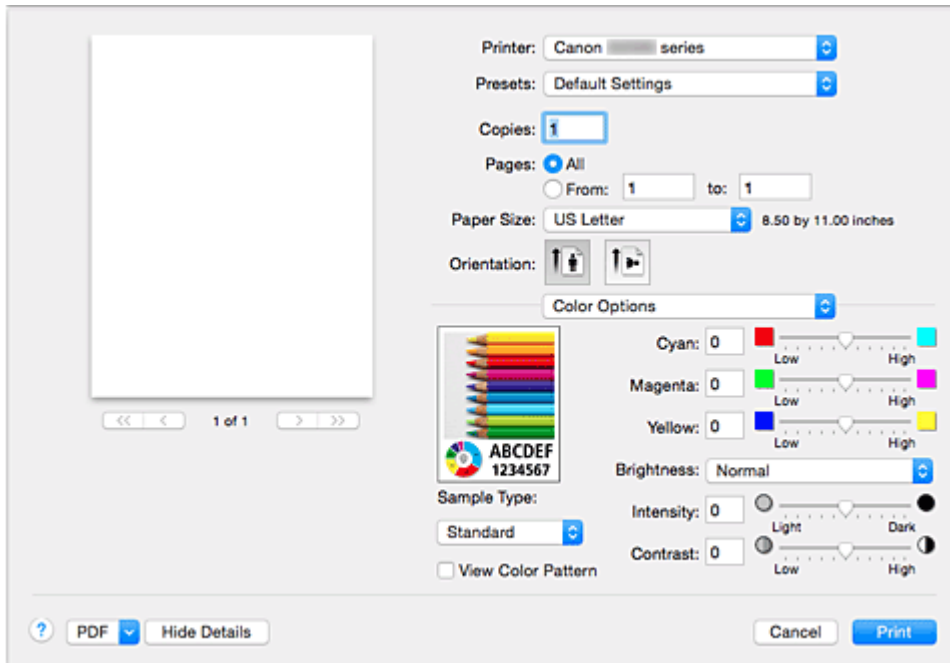

Preview

Shows the effect of color adjustment.

As you adjust each item, the effects are reflected in the color and brightness.

Sample Type

Select an image that you want to display as a sample.

If necessary, select one from **Standard**, **Landscape**, or **Graphics**, whichever is most similar to the print results.

View Color Pattern

Displays a pattern for checking color changes produced by color adjustment.

When you want to display the sample image with a color pattern, check this check box.

When you want to display the sample image with one that you selected with **Sample Type**, uncheck this check box.

▶▶▶ Note

- When the **Grayscale Printing** check box is checked in the **Quality & Media**, the graphic is displayed in monochrome.

Color balance (Cyan, Magenta, Yellow)

If necessary, adjust the strength of each color. To strengthen a color, drag the slider to the right. To weaken a color, drag the slider to the left.

You can also directly enter a value linked to the slider. Enter a value in the range from -50 to 50.

Adjusting the color balance will result in variations in the balance among the volumes of the individual color inks and hence in the hues of the document as a whole.

Use the printer driver only when adjusting the color balance slightly. To change the color balance significantly, use the application software.

Brightness

Select the brightness of printed images.

You cannot change the levels of pure white and black. You can change the contrast of the colors between white and black.

Select from **Light**, **Normal**, or **Dark**, if necessary.

Intensity

Select this method to adjust the overall density of your print.

To increase the overall intensity, drag the slider to the right. To decrease the overall intensity, drag the slider to the left.

You can also directly enter a value linked to the slider. Enter a value in the range from -50 to 50.

Contrast

The Contrast function changes the differences between light and dark in images during printing.

To make the differences between the light and dark portions of images greater and more distinct, increase the contrast. On the other hand, to make the differences between the light and dark portions of images smaller and less distinct, reduce the contrast.

You can also directly enter a value linked to the slider. Enter a value in the range from -50 to 50.

▶▶ Important

- When the **Grayscale Printing** check box is checked for **Quality & Media**, the color balance (**Cyan**, **Magenta**, **Yellow**) appear grayed out and are unavailable.
- If you select **ColorSync** for **Color Matching**, then the color balance (**Cyan**, **Magenta**, **Yellow**), **Brightness**, **Intensity**, and **Contrast** appear grayed out and are unavailable.

Related Topics

- [Specifying Color Correction](#)
- [Adjusting Color Balance](#)
- [Adjusting Brightness](#)
- [Adjusting Intensity](#)
- [Adjusting Contrast](#)

Borderless Printing

This dialog allows you to adjust the amount of the document that extends off the paper when borderless printing is performed.

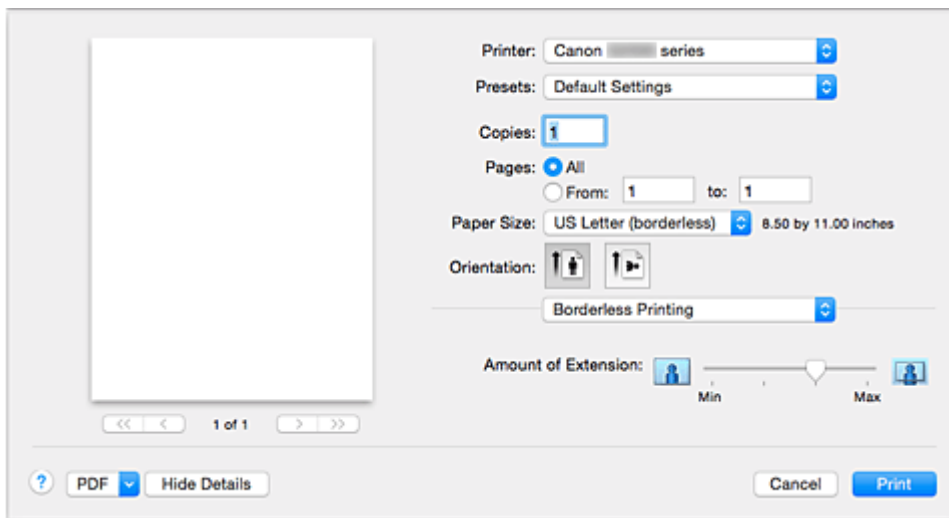

Amount of Extension

Use the **Amount of Extension** slider to adjust the amount of the document that extends off the paper. Moving the slider to the right makes the amount larger and moving the slider to the left makes the amount smaller.

Related Topic

- [Execute Borderless Printing](#)

Margin

This dialog allows you to set the stapling side and amount of margin for stapling multiple sheets of paper.

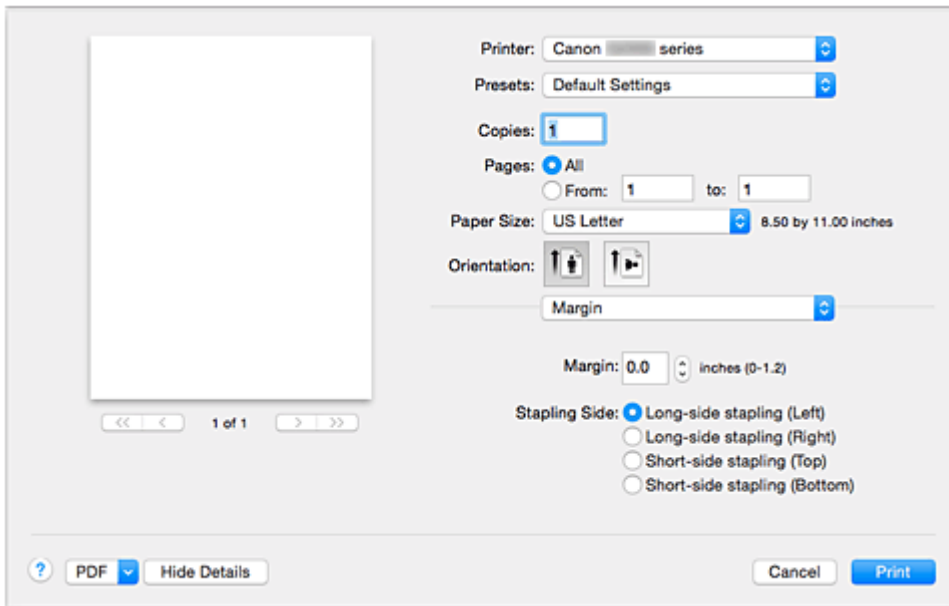

Margin

Specify the amount of margin space for stapling the paper. Enter a value between 0 inch (0 mm) to 1.2 inches (30 mm).

Stapling Side

Specify the stapling side.

Long-side stapling (Left) / Long-side stapling (Right)

Select this option to staple the long side of the paper.

Choose left or right.

Short-side stapling (Top) / Short-side stapling (Bottom)

Select this option to staple the short side of the paper.

Choose top or bottom.

Related Topic

- [Setting the Stapling Margin](#)

Canon IJ Printer Utility

The Canon IJ Printer Utility allows you to perform printer maintenance or change the settings of the printer.

What You Can Do with the Canon IJ Printer Utility

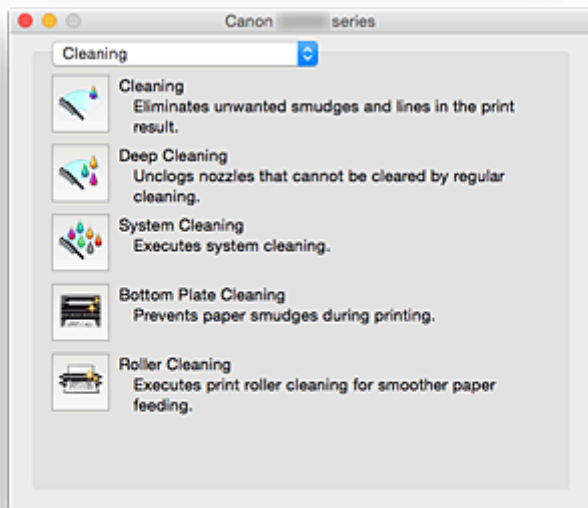

You can switch between pages in Canon IJ Printer Utility by the pop-up menu. You can choose one of the following items from the pop-up menu.

Cleaning

Clean the printer to prevent print smudges and clear up clogged print head nozzle.

- [Cleaning the Print Heads](#)
- [Cleaning Inside the Printer](#)
- [Cleaning the Paper Feed Rollers](#)

Test Print

Execute a test print to check the condition of the print head nozzle and to adjust the print head position.

- [Aligning the Print Head Position](#)
- [Printing a Nozzle Check Pattern](#)

Power Settings

Operate the power of this printer from the printer driver.

Remaining ink level setting

The function allows you to switch the remaining ink level notification setting and to reset the remaining ink level count.

Quiet Settings

You can reduce the operating noise of the printer.

Custom Settings

Change the settings of this printer.

▶▶ Note

- To operate the Canon IJ Printer Utility, you must first turn on the printer.
- Depending on the items selected, the computer communicates with the printer to obtain information. If the computer is unable to communicate with the printer, an error message may be displayed. If this happens, click **Cancel** to display the most recent settings specified on your computer.

Opening the Canon IJ Printer Utility

To open the Canon IJ Printer Utility, follow the steps below.

1. Open **System Preferences**, and select **Printers & Scanners (Print & Scan)**

2. Start the Canon IJ Printer Utility

Select your model from the printer list, and click **Options & Supplies...**

Click **Open Printer Utility** in **Utility** tab.

Canon IJ Printer Utility is launched.

Maintenance of this Printer

- **Cleaning the Print Heads**
- **Cleaning Inside the Printer**
- **Cleaning the Paper Feed Rollers**
- **Printing a Nozzle Check Pattern**
- **Aligning the Print Head Position**
- **Managing the Printer Power**
- **Reducing the Printer Noise**
- **Changing the Printer Operation Mode**

Display the Printing Status Screen

Check the print progress according to the following procedure:

1. Launch the printing status screen

- If the print data has been sent to the printer

The printing status screen opens automatically. To display the printing status screen, click the  (the printer icon) displayed on the Dock.

- If the print data has not been sent to the printer

Open **System Preferences**, and select **Printers & Scanners (Print & Scan)**.





To display the printing status screen, select the name of your printer model from the printer list, and then click **Open Print Queue....**

2. Checking the printing status

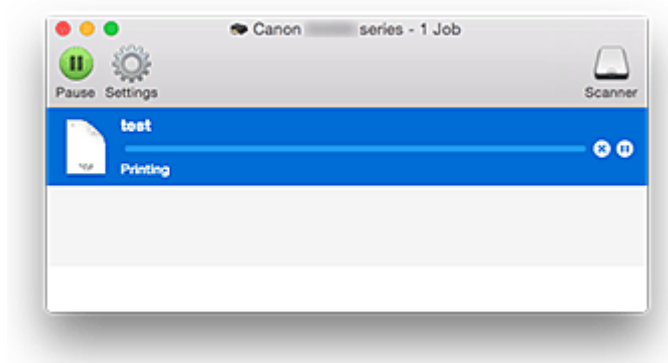
You can check the name of the file being printed or ready for being printed.







- If you are using OS X El Capitan v10.11, OS X Yosemite v10.10, OS X Mavericks v10.9, or OS X Mountain Lion v10.8

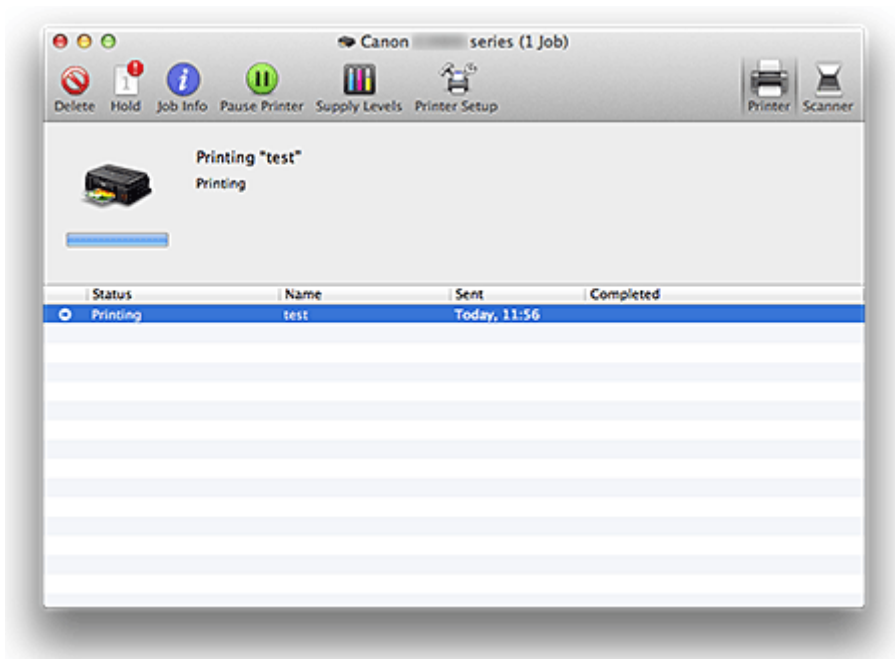

-  Deletes the specified print job.
-  Stops printing the specified document.
-  Resumes printing the specified document.
-  Stops printing all documents.
-  Displayed only when printing of all documents is being stopped, and resumes printing all documents.

- If you are using OS X Lion v10.7



-  Deletes the specified print job.
-  Stops printing the specified document.
-  Resumes printing the specified document.
-  Displays the print job information.
-  Stops printing all documents.
-  Displayed only when printing of all documents is being stopped, and resumes printing all documents.

▶▶▶ Note



- Depending on your model, the printer icon display may be different.

Deleting the Undesired Print Job

If the printer does not start printing, canceled or failed print job data may be remaining. Delete unnecessary print jobs from the print status check screen.

1. Open **System Preferences**, and select **Printers & Scanners (Print & Scan)**
2. Select your model, and then click **Open Print Queue...**

The print status check screen appears.

3. Select the unnecessary print job and click  ( **Delete**)

The selected print jobs will be deleted.

Instructions for Use (Printer Driver)

This printer driver is subject to the following restrictions. Keep the following points in mind when using the printer driver.

Restrictions on the Printer Driver

- When you set up the Page Setup dialog, be sure to begin by selecting the model you are using from the **Format For** list. If you select another printer, printing may not be performed properly.
- The following functions cannot be used in Mac OS, though they can be used in Windows computers.
 - Duplex Printing
 - Booklet Printing
 - Tiling/Poster Printing
- Depending on the application software that you are using, a preview may not be displayed on the left side of the Print dialog.
- If you connect this printer and AirPort with a USB cable and print, you must install the latest AirPort firmware.
- If you are using OS X Mavericks v10.9, close the print status check window when you perform printer maintenance from the Canon IJ Printer Utility.

Updating the Printer Driver

- **Obtaining the Latest Printer Driver**
- **Delete the Unnecessary Canon IJ Printer from the Printer List**
- **Before Installing the Printer Driver**
- **Installing the Printer Driver**

Obtaining the Latest Printer Driver

By updating the printer driver to the latest version of the printer driver, unresolved problems may be solved.

You can access our website and download the latest printer driver for your model.

Important

- You can download the printer driver for free, but any Internet access charges incurred are your responsibility.

Related Topics

- [Before Installing the Printer Driver](#)
- [Installing the Printer Driver](#)

Delete the Unnecessary Canon IJ Printer from the Printer List

A Canon IJ Printer that you no longer use can be deleted from the printer list.

Before deleting the Canon IJ Printer, disconnect the cable that connects the printer to the computer.

The procedure to delete the unnecessary Canon IJ Printer from the printer list is as follows:

You cannot delete the Canon IJ Printer unless you are logged in as a user with the administrative right. For information about an administrative user, refer to the user's manual for the Mac OS.

1. Open **System Preferences**, and select **Printers & Scanners (Print & Scan)**
2. Delete the Canon IJ Printer from the printer list

From the printer list, select the Canon IJ Printer to be deleted, and then click -.

Click **Delete Printer** when the confirmation message appears.

Before Installing the Printer Driver

This section describes the items that you should check before installing the printer driver. You should also refer to this section if the printer driver cannot be installed.

Checking the Printer Status

- Confirm that the USB port of this printer and the computer are firmly connected with the USB cable.

Checking the Personal Computer Settings

- Terminate all running applications.
- Log on as a user who has the administrator account. The installer will prompt you to enter the name and password of the administrative user. When multiple users are using Mac OS, log on with the account of the administrator who registered first.

»» Important

- When you upgrade Mac OS, all printer drivers that were installed will be deleted. If you plan to continue using this printer, re-install the latest printer driver.

Related Topics

- [Obtaining the Latest Printer Driver](#)
- [Installing the Printer Driver](#)

Installing the Printer Driver

You can access our web site through the Internet and download the latest printer driver for your model.

The procedure for installing the downloaded printer driver is as follows:

1. Mount the disk

Double-click the disk image file you have downloaded.

The file is unpacked, and then the disk is mounted.

2. Start the installer

Double-click "PrinterDriver_XXX_YYY.pkg" (where "XXX" is your model name, and "YYY" is version) contained in the disk.

3. Start the installation

Install the printer driver according to the messages on the screen.

When the Software License Agreement is displayed, check the contents, and click **Continue**. If you do not agree to the terms of the Software License Agreement, you cannot install this software.

4. Selecting the install destination

If necessary, select where you want to install the printer driver, and then click **Continue**.

5. Executing the installation

Click **Install**.

When the authentication screen is displayed, enter the name and password of the administrator, and then click **Install Software**.

6. Complete the installation

When the completion message appears, click **Close**.

The printer driver is installed successfully.

Important

- If the Installer does not operate properly, select **Quit Installer** from the **Installer** menu of the Finder to quit the Installer. Then start the Installer again.
- You can download the printer driver for free, but you are responsible for paying any connection fees to the Internet.

Related Topics

- [Obtaining the Latest Printer Driver](#)
- [Delete the Unnecessary Canon IJ Printer from the Printer List](#)
- [Before Installing the Printer Driver](#)

Sharing the Printer on a Network

When multiple computers are being used in the network environment, you can share the printer connected to one computer with the other computers.

Before carrying out the setup for printer sharing, select **Network** from **System Preferences**, and check whether the network settings have been set.

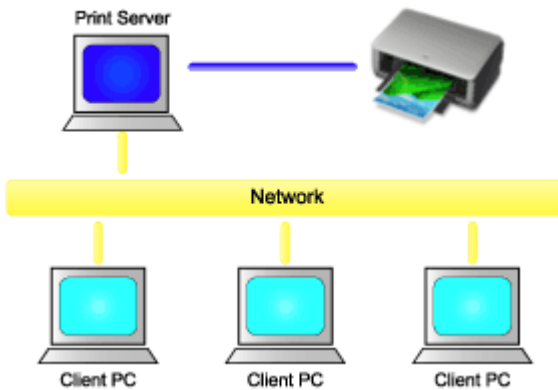

This section describes the procedure for sharing a printer among Mac.

- [Settings on Print Server](#)

This section describes the procedure for setting a computer that connects with this printer directly through a USB cable.

- [Settings on Client PC](#)

This section describes the procedure for setting a computer that uses this printer through a network. When you execute print, the data is sent to the printer through the print server system.

Related Topic

- [Restrictions on Printer Sharing](#)

Settings on Print Server

When you use the printer on a network, set up the printer driver for sharing on the print server system.

The procedure for setting up the print server systems is as follows:

1. [Install the printer driver](#) on the print server system

2. Check that the printer to be used has been added

Open **System Preferences**, and select **Printers & Scanners (Print & Scan)**.

The printer list displays the printers that are connected to the computer.

3. Set sharing

Check the **Share this printer on the network** check box.

▶▶▶ Note

- Depending on the environment you are using, a message prompting you to restart the computer may be displayed. To complete the installation properly, restart the computer.

The setup on the print server system is complete. Next, set up the client systems.

Settings on Client PC

After setting up the print server system, set up the client system.

The procedure for setting up the client systems is as follows:

1. [Install the printer driver](#) on the client systems

2. Display the printer list

Open **System Preferences**, and select **Printers & Scanners (Print & Scan)**.

Click **+** to display the printer list.

3. Add a printer to be shared

Select a shared printer displayed in the printer list, and then click **Add**.

The setup on the client systems is now completed.

»» Note

- The print procedures are the same as when the computer is connected directly to the printer with a USB cable.
At the Page Setup dialog, select the printer that is connected to the print server to be used.

Restrictions on Printer Sharing

These are restrictions that apply when you are using a printer in a network environment.

- Install the same version of the printer driver in the print server system and the client systems. You can download the latest printer driver from our web site.
- Use printer sharing with users who have the administrator privilege.
- Depending on how the computer is connected with the printer, the computer may not be able to access the function information that was set on the printer and display the correct settings.

Printing Using Canon Application Software

- ▶ [My Image Garden Guide](#)

My Image Garden Guide

You can learn about the operations and screens of My Image Garden.



For Windows:

Latest Version

My Image Garden V3.3.x/V3.2.x

It is recommended that you use the latest version of the application.

Access the Canon website and download the latest application.

[How to Check the Version](#)

Earlier Versions

Select the version of your My Image Garden.

- V3.1.x/V3.0.x
- V2.1.x
- V2.0.x
- V1.1.x

For Mac OS:

Latest Version

My Image Garden V3.3.x/V3.2.x

It is recommended that you use the latest version of the application.

Access the Canon website and download the latest application.

[How to Check the Version](#)

Earlier Versions

Select the version of your My Image Garden.

- V3.1.x/V3.0.x
- V2.1.x
- V2.0.x
- V1.1.x

Copying

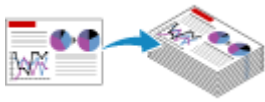

Making Copies on Plain Paper **Basics**



Switching Page Size between A4 and Letter

Making Copies on Plain Paper

Load the original on the platen glass to copy on A4 sized plain paper.

1. [Make sure machine is turned on.](#)
2. [Load A4 or Letter-sized plain paper.](#)
3. [Load original on platen glass.](#)

▶▶▶ Note

- You can switch the size of paper loaded in the rear tray between A4 and Letter.

■ [Switching Page Size between A4 and Letter](#)

4. Press **Color** button for color copying, or **Black** button for black & white copying.

The machine starts copying.

Remove the original on the platen glass after copying is complete.

- **To make multiple copies**

Press the **Color** button or the **Black** button repeatedly according to the number of copies you want.

Press the same button (**Color** button or **Black** button) as the one which you previously pressed.

- **To cancel copying:**

Press the **Stop** button.

▶▶▶ Important

- Do not open the document cover or remove the original from the platen glass until scanning is completed.

While the machine is scanning the original, the **ON** lamp keeps flashing.

▶▶▶ Note

- **To set the print quality to "Draft" (speed priority)**

You can set the print quality to "Draft" (speed priority) following the procedure below.

1. Press and hold down **Color** or **Black** button for 2 or more seconds in step 4.

The **ON** lamp flashes once.

2. Release button.

The machine starts copying.

When the print quality is set to "Draft", print speed is given priority over quality. To give priority to quality, press the **Color** or **Black** button for less than 2 seconds to copy in the print quality "Standard".

Switching Page Size between A4 and Letter

You can switch the size of paper loaded in the rear tray between A4 and Letter.

This setting is useful if you usually load Letter-sized paper in the rear tray.

1. [Make sure machine is turned on.](#)
2. Press and hold **Stop** button and release it when **Alarm** lamp flashes 14 times.
The **ON** lamp starts flashing instead of remaining lit.
3. Press **Black** button to select A4, or **Color** button to select Letter.

The **ON** lamp stops flashing and remains lit and the paper size is changed.

Note

- When you switch the page size to A4 or Letter, load paper of the selected size.
When the page size is set to A4, load A4 plain paper.
When the page size is set to Letter, load Letter-sized plain paper.
- This setting is retained even if the machine is turned off.

Scanning



Scanning from Computer (Windows)



Scanning from Computer (Mac OS)

Scanning from Computer (Windows)

- ▶ **Using IJ Scan Utility**
- ▶ **Scanning Using Application Software (ScanGear)**
- ▶ **Other Scanning Methods**
- ▶ **Scanning Tips**
- ▶ **Positioning Originals (Scanning from Computer)**

Scanning from Computer (Mac OS)

- ▶ [Using IJ Scan Utility](#)
- ▶ [Using Scanner Driver](#)
- ▶ [Scanning Tips](#)
- ▶ [Positioning Originals \(Scanning from Computer\)](#)

Using IJ Scan Utility

- ▶ **What Is IJ Scan Utility (Scanner Software)?**
- ▶ **Starting IJ Scan Utility**
- ▶ **Easy Scanning with Auto Scan** 📄 **Basics**
- ▶ **Scanning Documents**
- ▶ **Scanning Photos**
- ▶ **Scanning with Favorite Settings**
- ▶ **Scanning Originals Larger than the Platen (Image Stitch)**
 - Adjusting Cropping Frames in the **Image Stitch** Window
- ▶ **Scanning Multiple Originals at One Time**
- ▶ **Saving after Checking Scan Results**
- ▶ **Sending Scanned Images via E-mail**
- ▶ **Extracting Text from Scanned Images (OCR)**
- ▶ **IJ Scan Utility Screens**

What Is IJ Scan Utility (Scanner Software)?

IJ Scan Utility is an application that allows you to easily scan documents, photos, etc.

You can complete from scanning to saving at one time by simply clicking the corresponding icon in the IJ Scan Utility main screen.

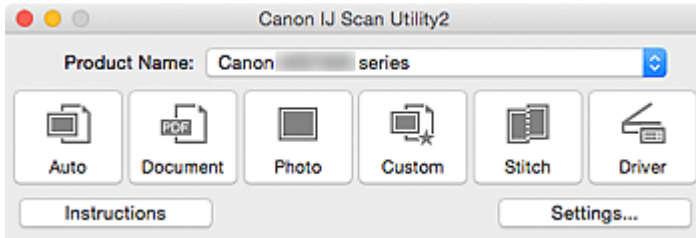

What You Can Do with IJ Scan Utility

Scan Easily according to Purposes

You can scan by simply clicking an icon such as **Auto** to scan easily, **Document** to sharpen text in a document or magazine for better readability, or **Photo** to scan with settings suitable for photos, according to the item type or your purpose.

►►► Note

- Refer to "[IJ Scan Utility Main Screen](#)" for details on the IJ Scan Utility main screen.

Save Scanned Images Automatically

Scanned images are automatically saved in a preset folder. You can change the folder as required.

►►► Note

- The default save folder is the **Pictures** folder.
- Refer to "[Settings Dialog](#)" for how to specify a folder.

Integrate with Applications

You can utilize scanned images through integration with other applications; display scanned images in your favorite application, attach them to e-mails, extract text from images, and more.

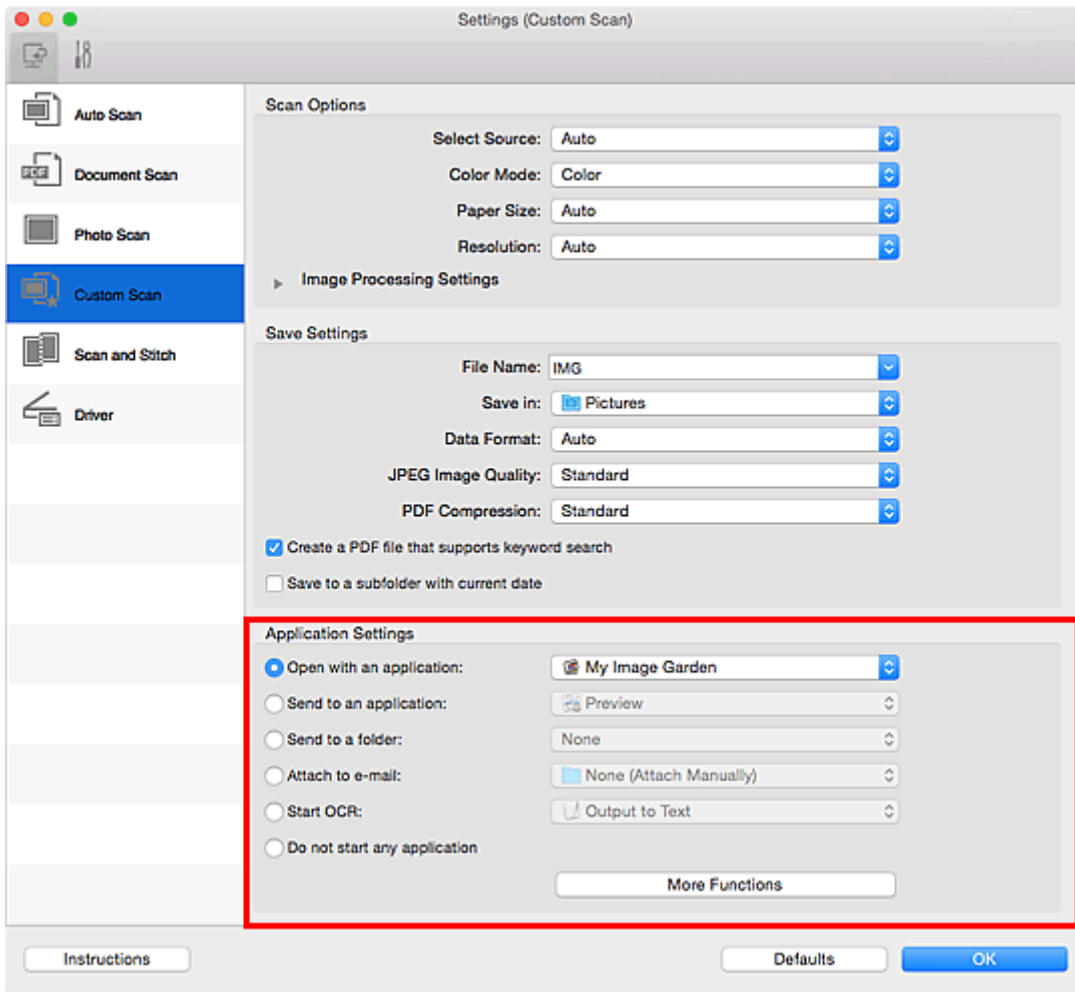

»»» Important

- Some functions are available only when My Image Garden is installed.

»»» Note

- Refer to "[Settings Dialog](#)" for how to set the applications to integrate with.

Starting IJ Scan Utility

From the **Go** menu of Finder, select **Applications**, then double-click the **Canon Utilities** folder, **IJ Scan Utility** folder, and then **Canon IJ Scan Utility2** icon to start IJ Scan Utility.

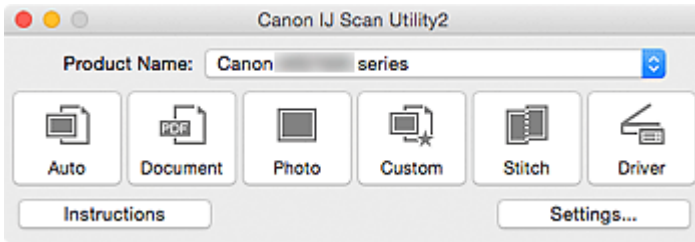

Easy Scanning with Auto Scan

You can scan easily by automatically detecting the item type.

▶▶▶ Important

- The following types of items may not be scanned correctly. In that case, adjust the cropping frames (selection boxes; scan areas) in the screen displayed by clicking **Driver** in the IJ Scan Utility main screen and scan again.
 - Photos that have a whitish background
 - Items printed on white paper, hand-written documents, business cards, etc.
 - Thin items
 - Thick items

1. Make sure that your scanner or printer is turned on.
2. Place items on the platen of your scanner or printer.
 - [Positioning Originals \(Scanning from Computer\)](#)
3. [Start IJ Scan Utility.](#)
4. Click **Auto**.

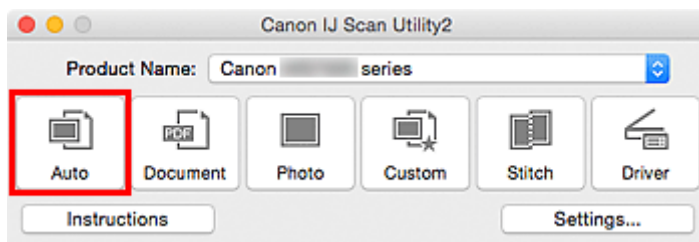

Scanning starts.

▶▶▶ Note

- Click **Cancel** to cancel the scan.
- To apply suitable corrections based on the item type, click **Settings...**, then select the **Apply recommended image correction** checkbox in the **Settings (Auto Scan)** dialog.
- Scanned images are saved in the folder set for **Save in** in the [Settings \(Auto Scan\) dialog](#) displayed by clicking **Settings...**. In the **Settings (Auto Scan)** dialog, you can also make advanced scan settings.
- Refer to the following pages to scan by specifying the item type.
 - [Scanning Photos](#)
 - [Scanning Documents](#)
 - [Scanning with Favorite Settings](#)

Scanning Documents

You can scan items placed on the platen with settings suitable for documents.

1. Place the item on the platen.

■ [Positioning Originals \(Scanning from Computer\)](#)

2. [Start IJ Scan Utility.](#)

3. Click **Settings...**, then set the paper size, resolution, etc. in the [Settings \(Document Scan\) dialog](#) as required.

When setting is completed, click **OK**.

4. Click **Document**.

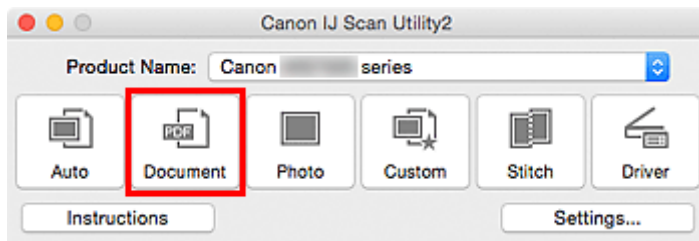

Scanning starts.

▶▶▶ Note

- Click **Cancel** to cancel the scan.
- Scanned images are saved in the folder set for **Save in** in the [Settings \(Document Scan\) dialog](#) displayed by clicking **Settings...**. In the **Settings (Document Scan)** dialog, you can also make advanced scan settings.

Scanning Photos

You can scan photos placed on the platen with settings suitable for photos.

1. Place the photo on the platen.

■ [Positioning Originals \(Scanning from Computer\)](#)

2. [Start IJ Scan Utility.](#)

3. Click **Settings...**, then set the paper size, resolution, etc. in the [Settings \(Photo Scan\) dialog](#) as required.

When setting is completed, click **OK**.

4. Click **Photo**.

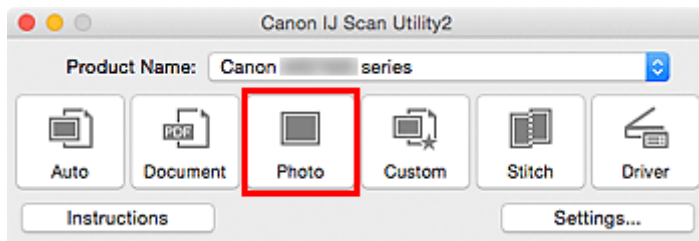

Scanning starts.

▶▶▶ Note

- Click **Cancel** to cancel the scan.
- Scanned images are saved in the folder set for **Save in** in the [Settings \(Photo Scan\) dialog](#) displayed by clicking **Settings...** In the **Settings (Photo Scan)** dialog, you can also make advanced scan settings.

Scanning with Favorite Settings

You can scan items placed on the platen with your favorite settings saved beforehand.

This is convenient for saving frequently used settings or when specifying scan settings in detail.

1. [Start IJ Scan Utility](#).
2. Click **Settings...**, then set the item type, resolution, etc. in the [Settings \(Custom Scan\) dialog](#) as required.

When setting is completed, click **OK**.

▶▶▶ Note

- Once the settings are made, you can scan with the same settings from the next time.

3. Place the item on the platen.

■ [Positioning Originals \(Scanning from Computer\)](#)

4. Click **Custom**.

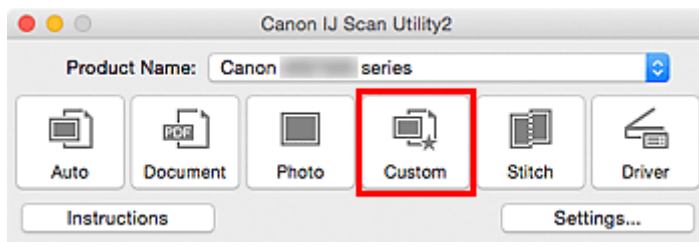

Scanning starts.

▶▶▶ Note

- Click **Cancel** to cancel the scan.
- Scanned images are saved in the folder set for **Save in** in the [Settings \(Custom Scan\) dialog](#) displayed by clicking **Settings...**. In the **Settings (Custom Scan)** dialog, you can also make advanced scan settings.

Scanning Originals Larger than the Platen (Image Stitch)

You can scan the left and right halves of an item larger than the platen and combine them back into one image. Items up to approximately twice as large as the platen are supported.

»»» Note

- The following explains how to scan from the item to be placed on the left side.

1. [Start IJ Scan Utility](#).
2. Click **Settings...**, then set the item type, resolution, etc. in the [Settings \(Scan and Stitch\) dialog](#) as required.

When setting is completed, click **OK**.

3. Click **Stitch**.

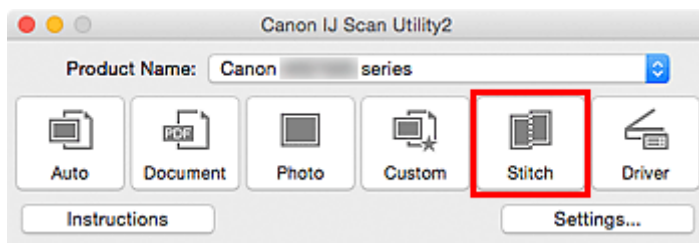

The **Image Stitch** window appears.

4. In **Select Output Size**, select an output size according to the paper size.

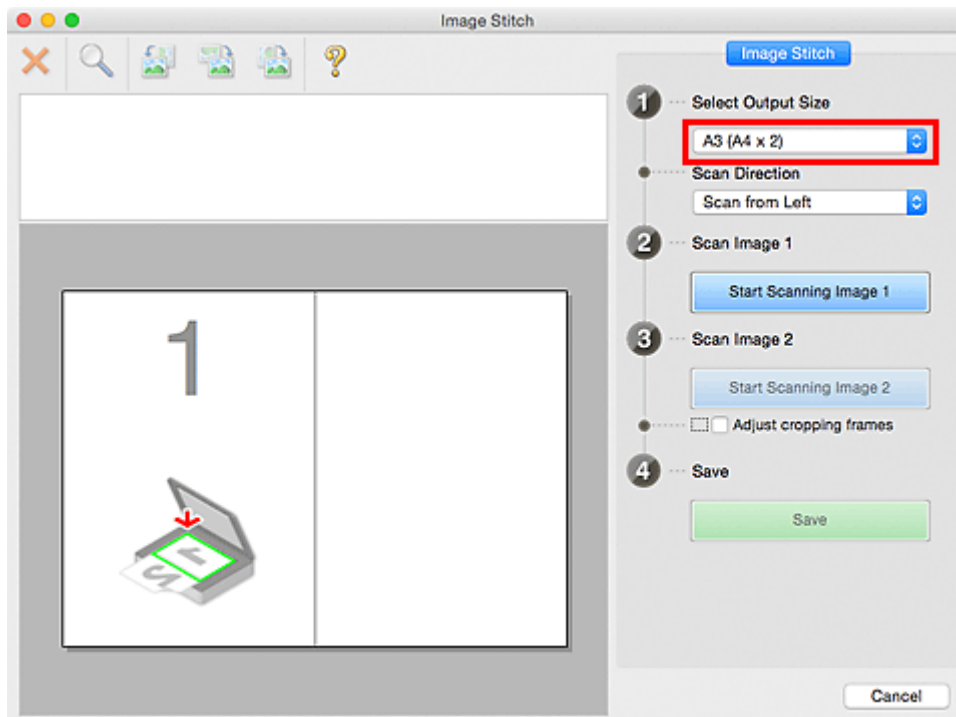

5. Make sure that **Scan from Left** is selected in **Scan Direction**.

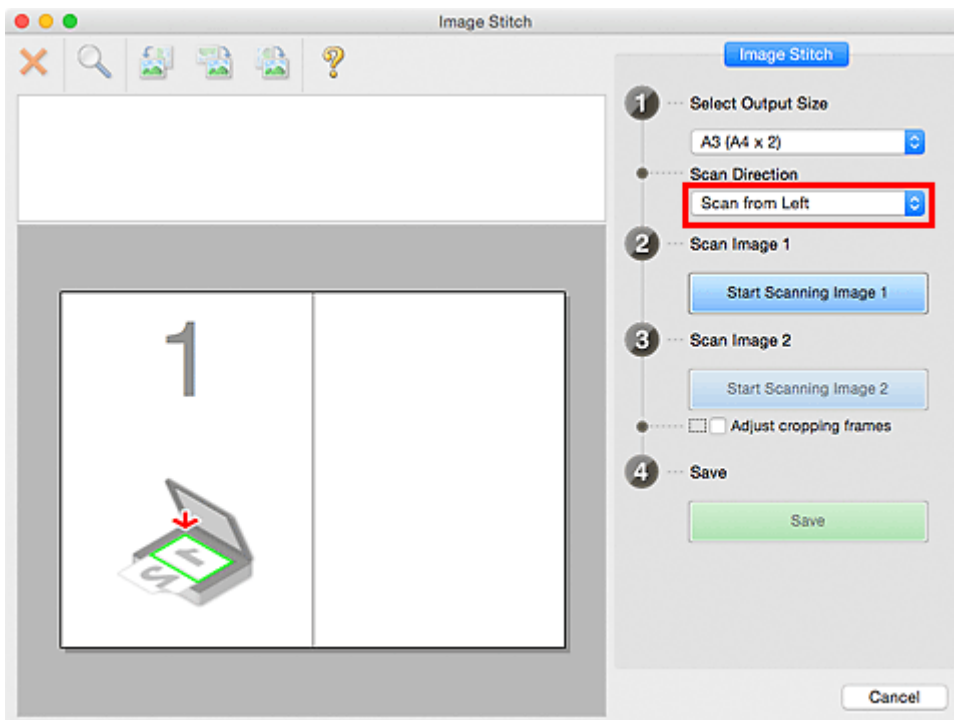

6. Place the item that is to be displayed on the left side of the screen face-down on the platen.

7. Click **Start Scanning Image 1**.

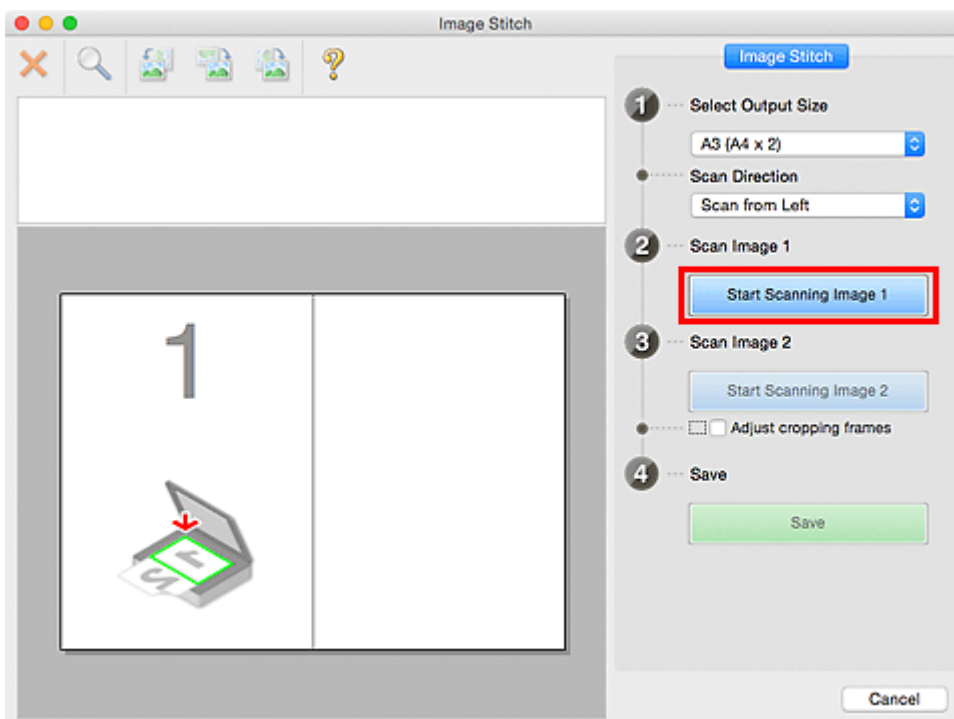

The first item is scanned and appears in 1.

»» Note

- Click **Cancel** to cancel the scan.

8. Place the item that is to be displayed on the right side of the screen face-down on the platen.

9. Click **Start Scanning Image 2**.

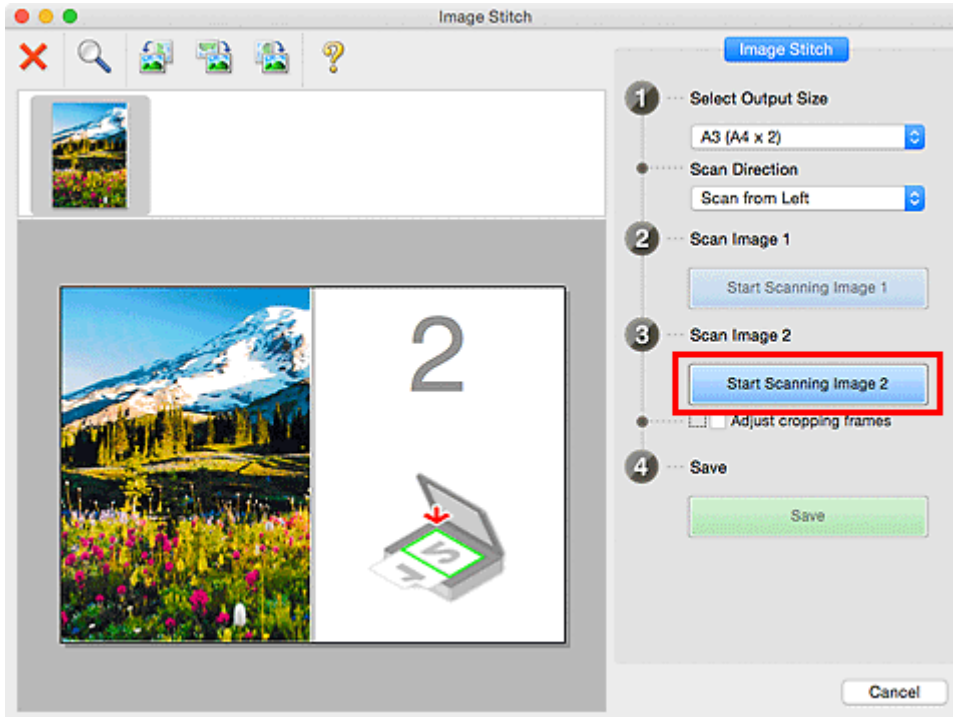

The second item is scanned and appears in 2.

»» Note

- Click **Cancel** to cancel the scan.

10. Adjust the scanned images as required.

Use the Toolbar to rotate or zoom in/out, or drag the images to adjust their positions.

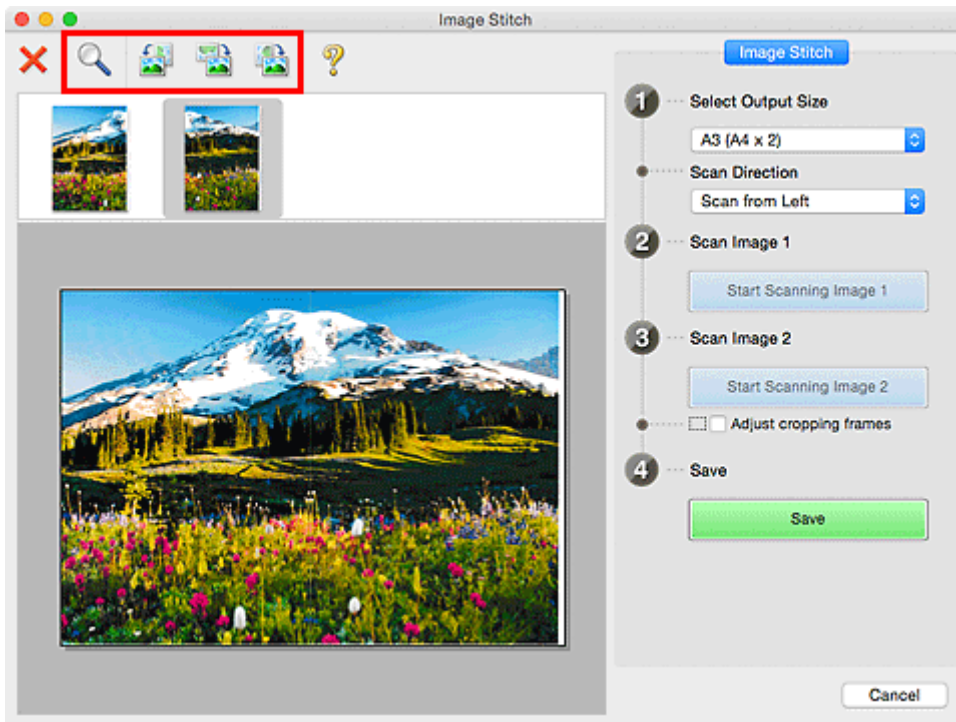

►► Note

- Select the **Adjust cropping frames** checkbox to specify the area to be saved.
 - [Adjusting Cropping Frames in the Image Stitch Window](#)
- To scan an item again, select the image in the Preview area or the thumbnail at the top of the screen, then click  (Delete). The selected image is deleted, allowing you to scan the item again.

11. Click **Save**.

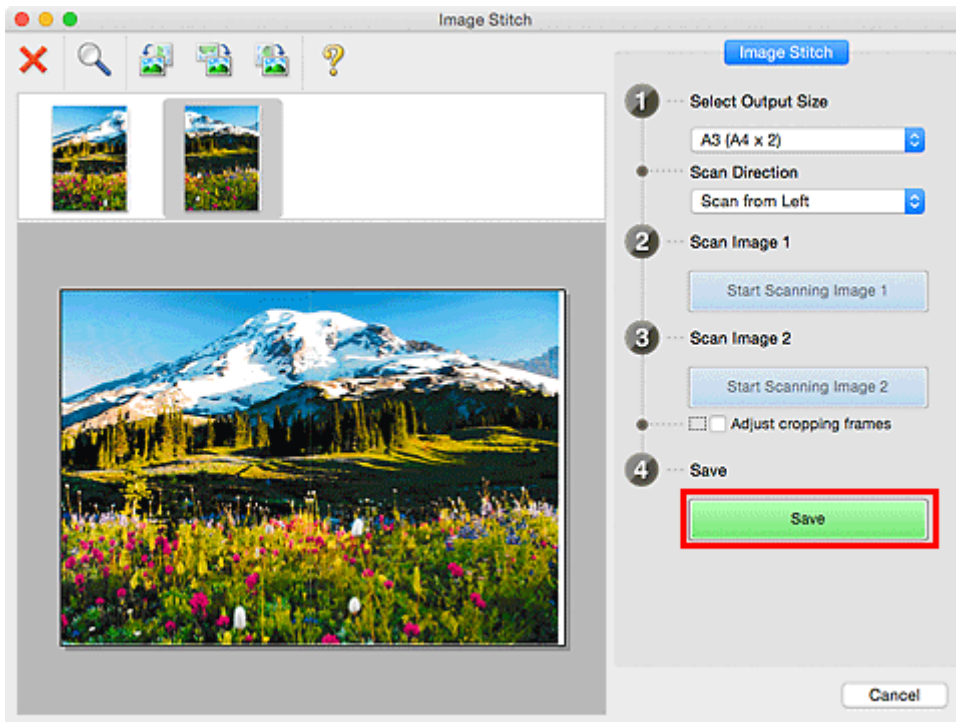

The combined image is saved.

▶▶▶ Note

- Refer to "[Image Stitch Window](#)" for details on the **Image Stitch** window.
- You can make advanced scan settings in the [Settings \(Scan and Stitch\) dialog](#) displayed by clicking **Settings...**

Adjusting Cropping Frames in the Image Stitch Window

"Cropping" is the act of selecting the area you want to keep in an image and discarding the rest when scanning it.

In the **Image Stitch** window, you can specify a cropping frame on the image displayed in the Preview area.

»» Note

- Refer to Help of Image Capture for how to adjust the cropping frames (selection boxes) in the screen displayed by clicking **Driver** in the IJ Scan Utility main screen.

Initial Cropping Frame

No cropping frame is specified. When you select the **Adjust cropping frames** checkbox, an active cropping frame is automatically specified around the image in the Preview area. You can drag the cropping frame to specify the area.

When you perform a scan, the image in the area specified with the cropping frame will be scanned.

Adjusting a Cropping Frame

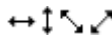
The cursor will change into  (Arrow) when it is positioned over a cropping frame. Click and drag the mouse to expand or contract the cropping frame.



The cursor will change into  (Hand) when it is positioned within a cropping frame. Click and drag the mouse to move the entire cropping frame.



Deleting Cropping Frames

To delete the cropping frame, deselect the **Adjust cropping frames** checkbox.

Scanning Multiple Originals at One Time

You can scan two or more photos (small items) placed on the platen at one time and save each image individually.

»» Important

- The following types of items may not be scanned correctly. In that case, adjust the cropping frames (selection boxes; scan areas) in the screen displayed by clicking **Driver** in the IJ Scan Utility main screen and scan again.
 - Photos that have a whitish background
 - Items printed on white paper, hand-written documents, business cards, etc.
 - Thin items
 - Thick items

Using Auto Scan:

Whether there are multiple items or not is detected automatically. Click **Auto** in the IJ Scan Utility main screen and scan.

- [Easy Scanning with Auto Scan](#)

Not Using Auto Scan:

In the Settings dialog, set **Paper Size** to **Auto scan** and scan.

»» Note

- The screens for scanning with favorite settings are used as examples in the following descriptions.

1. Place the items on the platen.

- [Positioning Originals \(Scanning from Computer\)](#)

2. [Start IJ Scan Utility.](#)

3. Click **Settings....**

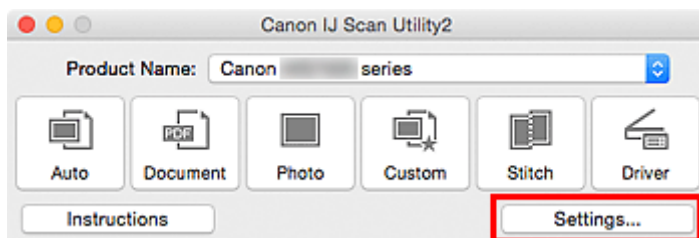

The Settings dialog appears.

4. Click **Custom Scan.**

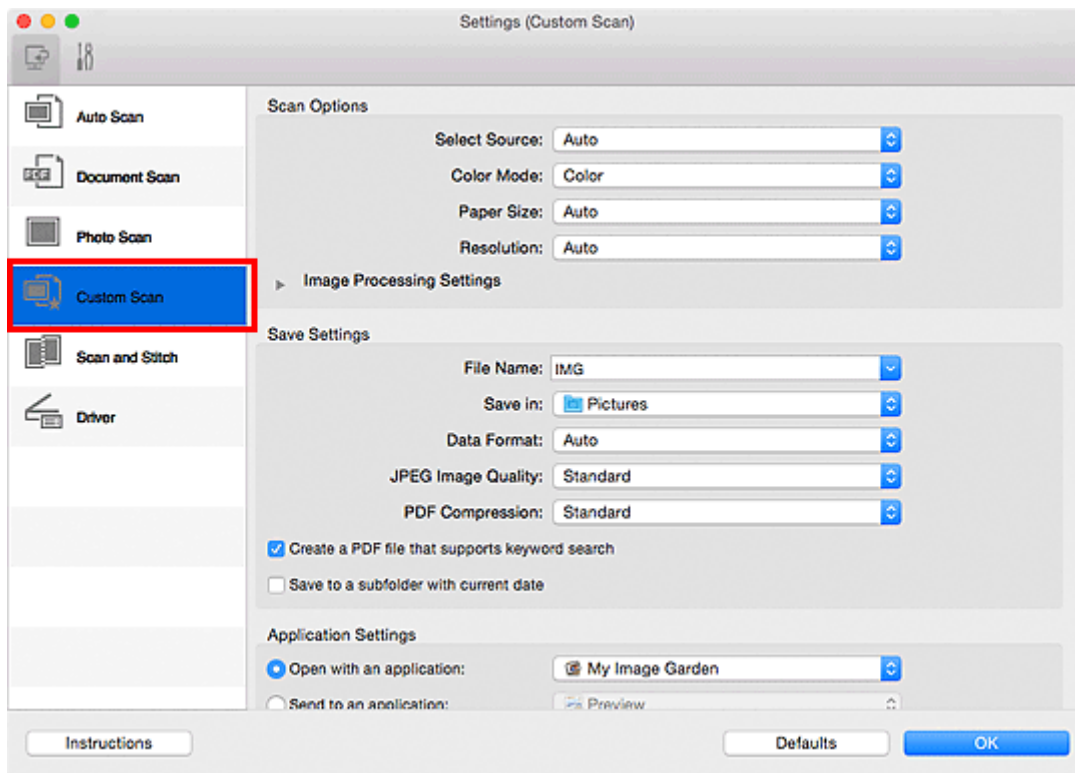

5. Select **Select Source** according to the items to be scanned.

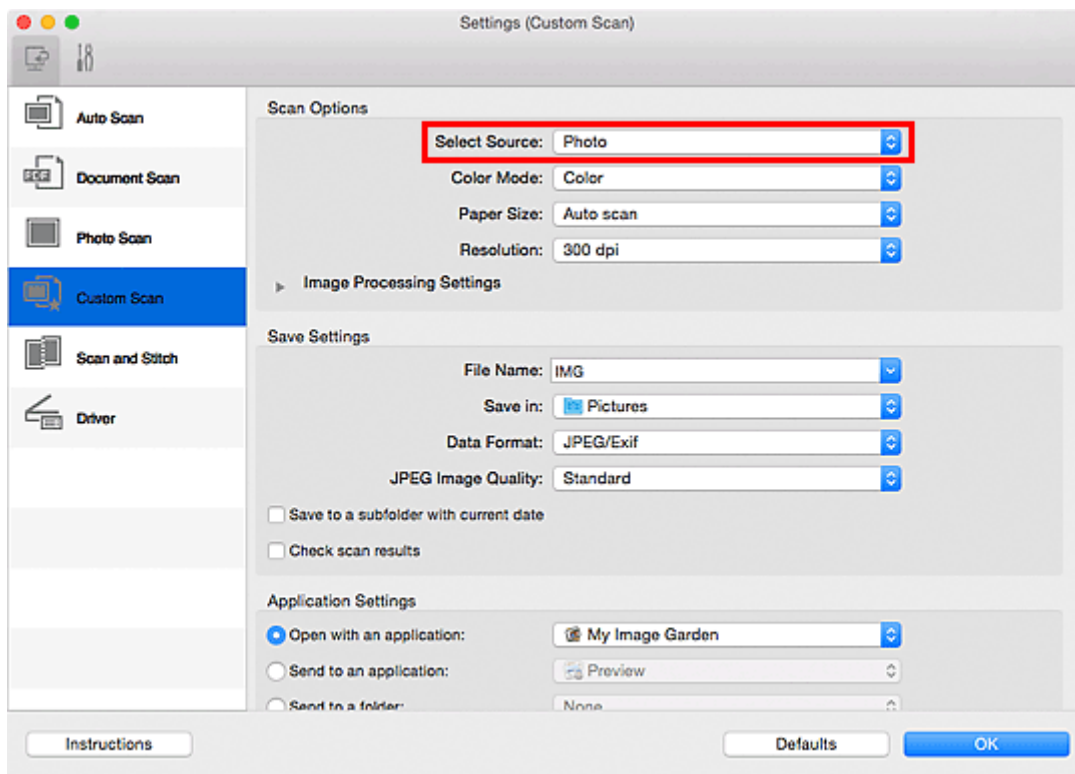

6. Select **Auto scan** for **Paper Size**, then click **OK**.

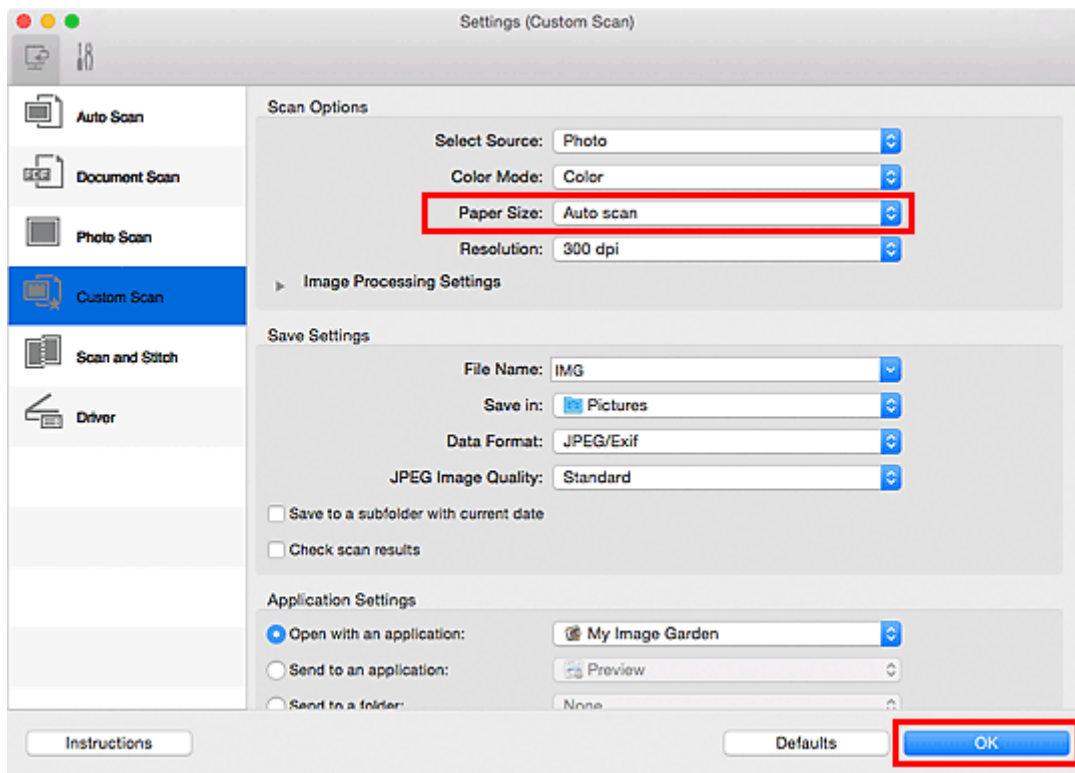

The IJ Scan Utility main screen appears.

▶▶▶ Note

- Refer to the following pages for details on the setting items in the Settings dialog.

■ [Settings \(Document Scan\) Dialog](#)

■ [Settings \(Photo Scan\) Dialog](#)

■ [Settings \(Custom Scan\) Dialog](#)

7. Click **Custom**.

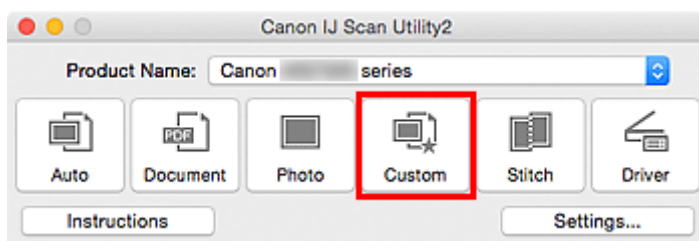

Multiple items are scanned at one time.

▶▶▶ Note

- Click **Cancel** to cancel the scan.
- Scanned images are saved in the folder set for **Save in** in the corresponding Settings dialog displayed by clicking **Settings...**. In each Settings dialog, you can also make advanced scan settings.

Saving after Checking Scan Results

You can check the scan results, then save the images to a computer.

▶▶▶ Important

- You cannot check the scan results before saving when scanned using **Auto** scan.

▶▶▶ Note

- The screens for scanning photos are used as examples in the following descriptions.

1. [Start IJ Scan Utility](#).
2. Click **Settings...**



The [Settings dialog](#) appears.

3. Click **Photo Scan**.

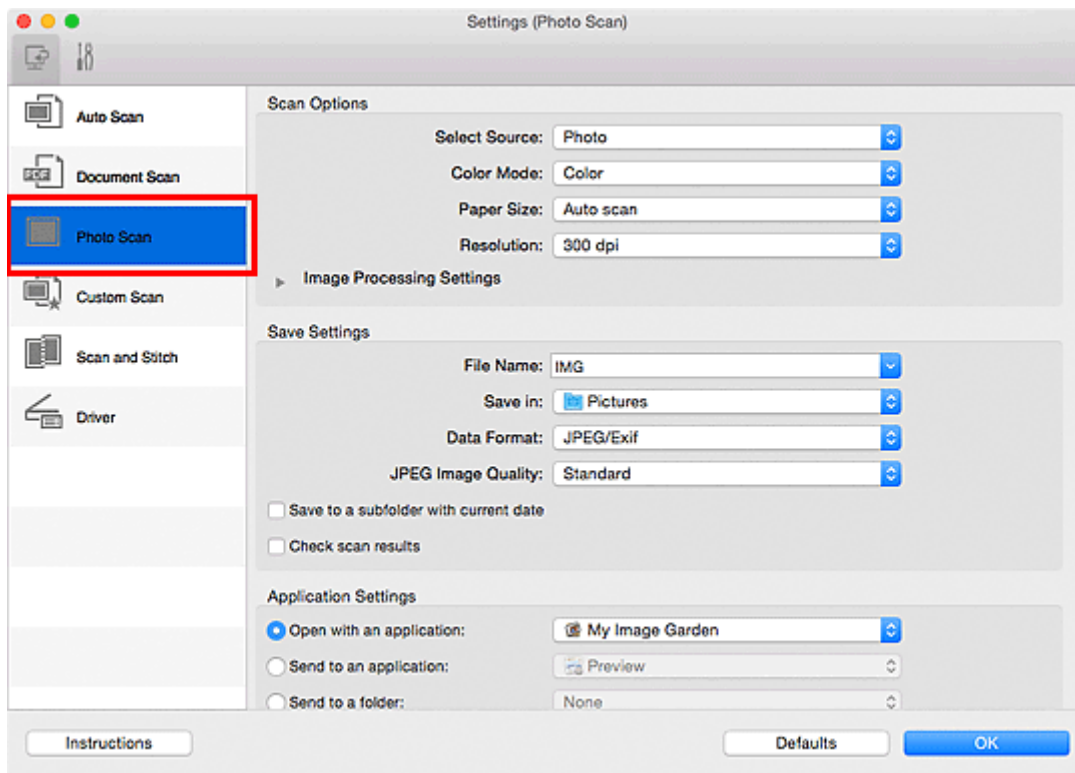

4. Select the **Check scan results** checkbox, then click **OK**.

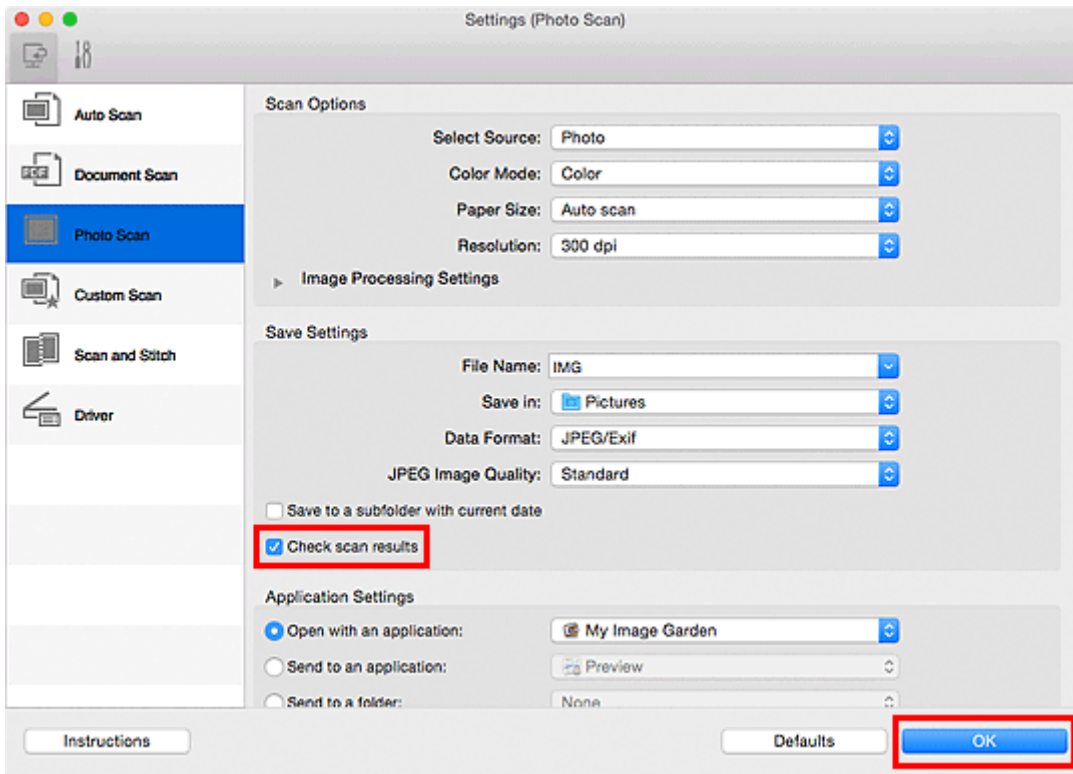

The IJ Scan Utility main screen appears.

►►► Note

- Refer to the following pages for details on the setting items in the Settings dialog.

- [Settings \(Document Scan\) Dialog](#)
- [Settings \(Photo Scan\) Dialog](#)
- [Settings \(Custom Scan\) Dialog](#)
- [Settings \(Scan and Stitch\) Dialog](#)
- [Settings \(Driver\) Dialog](#)

5. Click **Photo**.

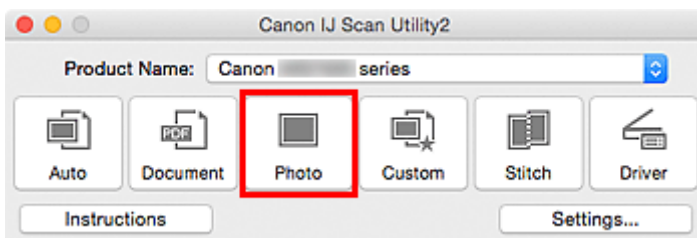

Scanning starts.

When scanning is completed, the **Save Settings** dialog appears.

►►► Note

- Click **Cancel** to cancel the scan.

6. Change the image order or file save options as required.

You can change the image order or file save options in the [Save Settings dialog](#).

▶▶ Note

- The default save folder is the **Pictures** folder.

7. Click **OK**.

Scanned images are saved according to the settings.

Sending Scanned Images via E-mail

You can send scanned images via e-mail.

▶▶▶ Note

- The screens for scanning photos are used as examples in the following descriptions.

1. [Start IJ Scan Utility](#).
2. Click **Settings...**

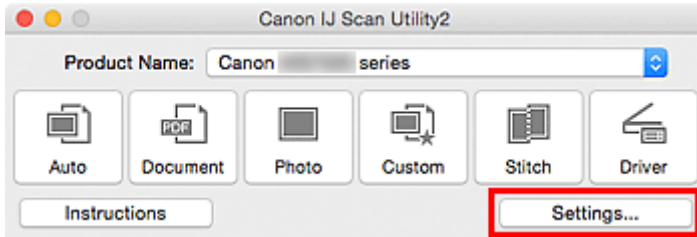

The [Settings dialog](#) appears.

3. Click **Photo Scan**.

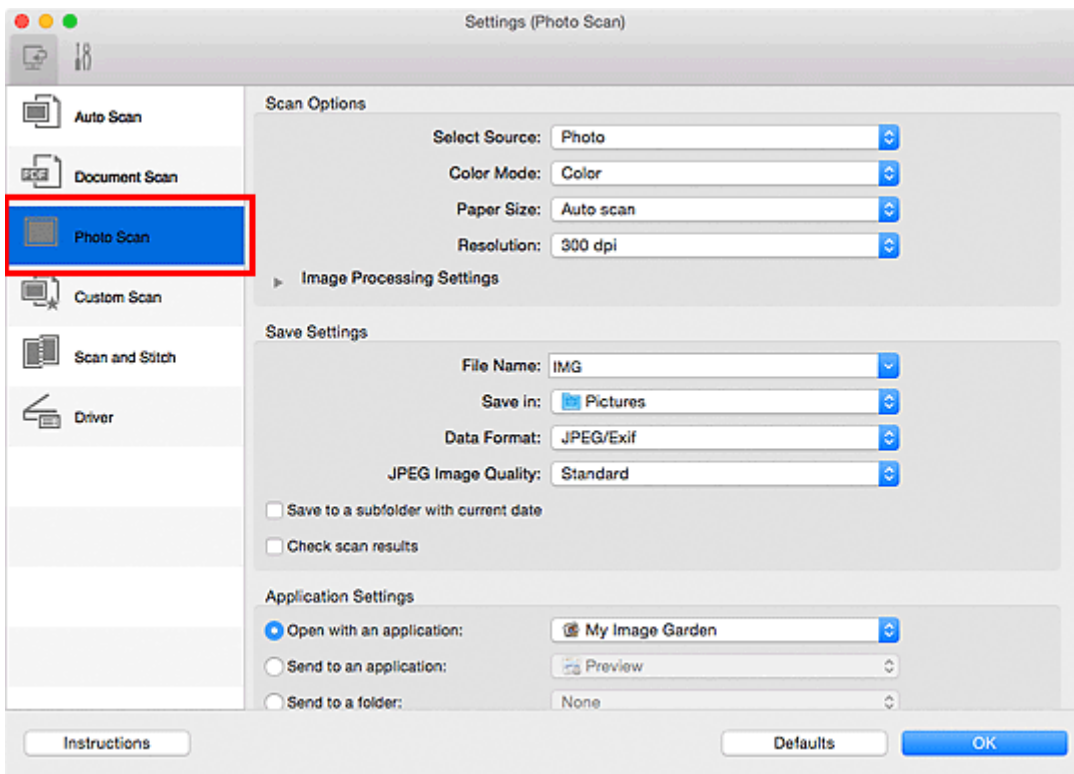

4. Select **Attach to e-mail** in **Application Settings**, then select an e-mail client.

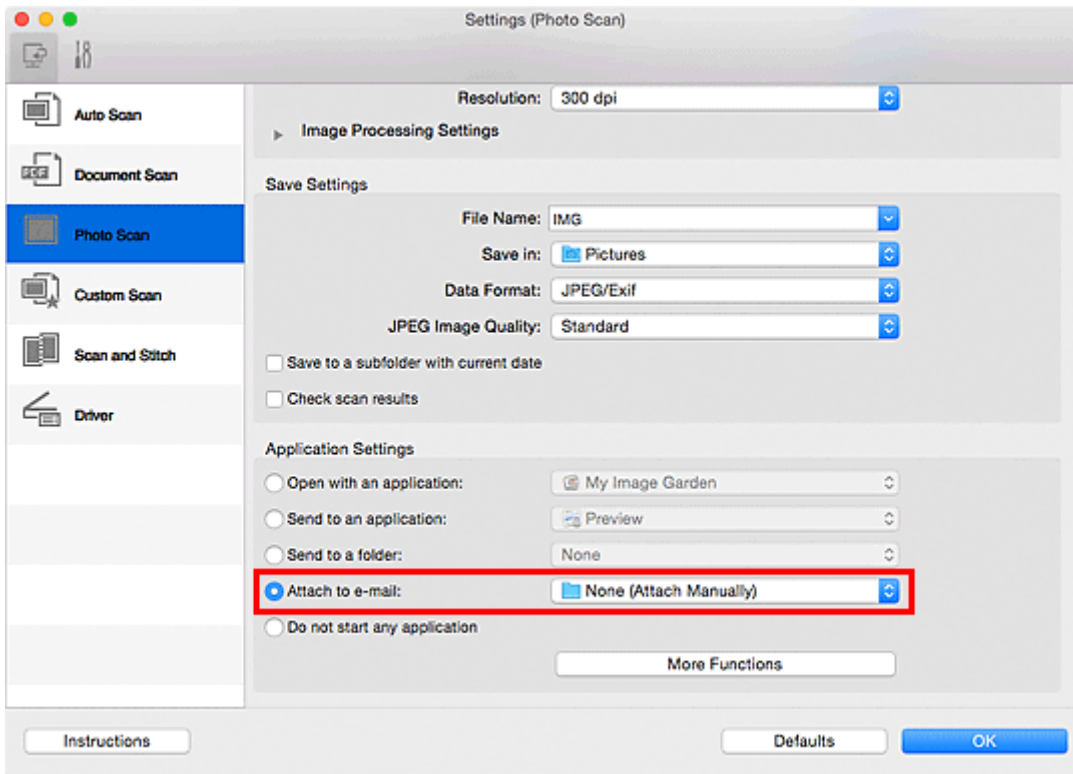

►► Note

- You can add e-mail clients to use for attachments from the pop-up menu.
- If **None (Attach Manually)** is selected, manually attach scanned and saved images to e-mail.

5. Click **OK**.

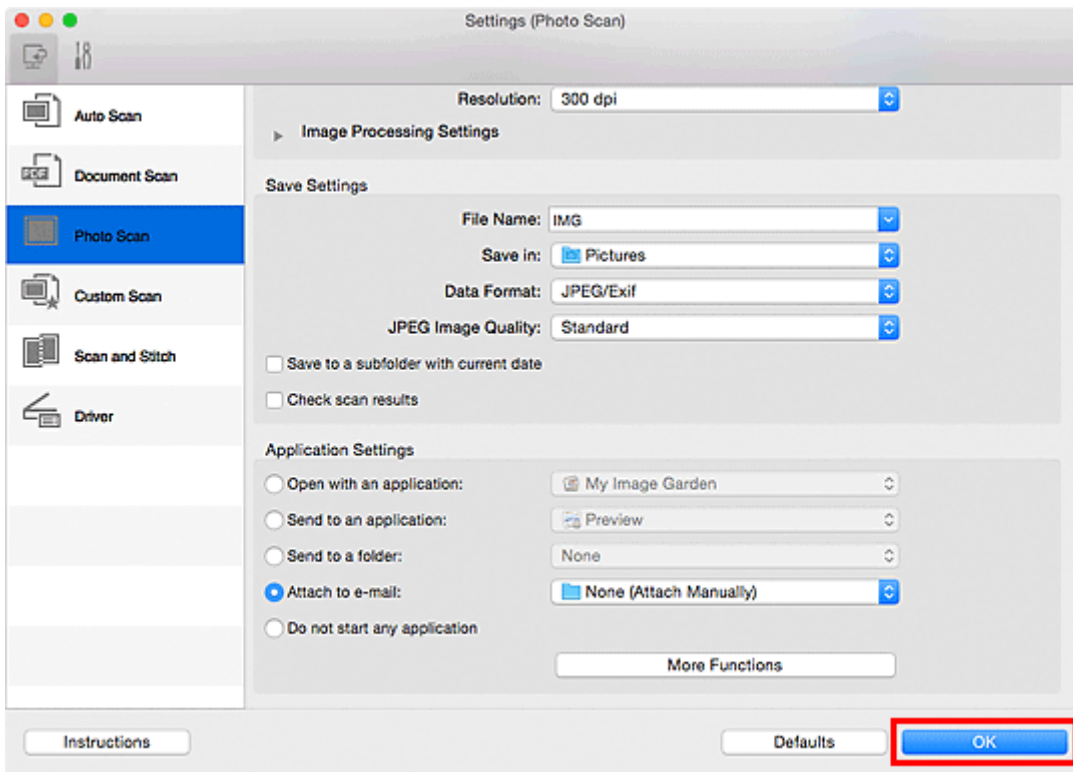

The IJ Scan Utility main screen appears.

▶▶▶ Note

- Refer to the following pages for details on the setting items in the Settings dialog.

- [Settings \(Auto Scan\) Dialog](#)
- [Settings \(Document Scan\) Dialog](#)
- [Settings \(Photo Scan\) Dialog](#)
- [Settings \(Custom Scan\) Dialog](#)
- [Settings \(Driver\) Dialog](#)

6. Click **Photo**.

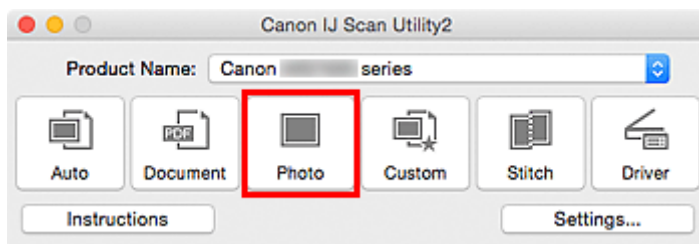

Scanning starts.

When scanning is completed, the specified e-mail client starts and the images will be attached to a new message.

▶▶▶ Note

- Click **Cancel** to cancel the scan.
- The scanned images are saved according to the settings made in the Settings dialog.
- When the **Check scan results** checkbox is selected in the Settings dialog, the [Save Settings dialog](#) appears. After you set the save options and click **OK**, the scanned images are saved and automatically attached to a new message of the specified e-mail client.

7. Specify the recipient, enter the subject and message, then send e-mail.

Refer to the manual of your e-mail client for e-mail settings.

Extracting Text from Scanned Images (OCR)

Scan text in scanned magazines and newspapers and display it in your text editor.

►►► Note

- You can extract text when scanning via **Document**, **Custom**, or **Driver**.
- The screens for scanning documents are used as examples in the following descriptions.

1. [Start IJ Scan Utility](#).
2. Click **Settings....**

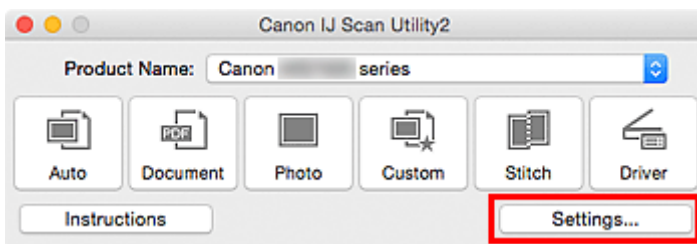

The [Settings dialog](#) appears.

3. Click **Document Scan**.

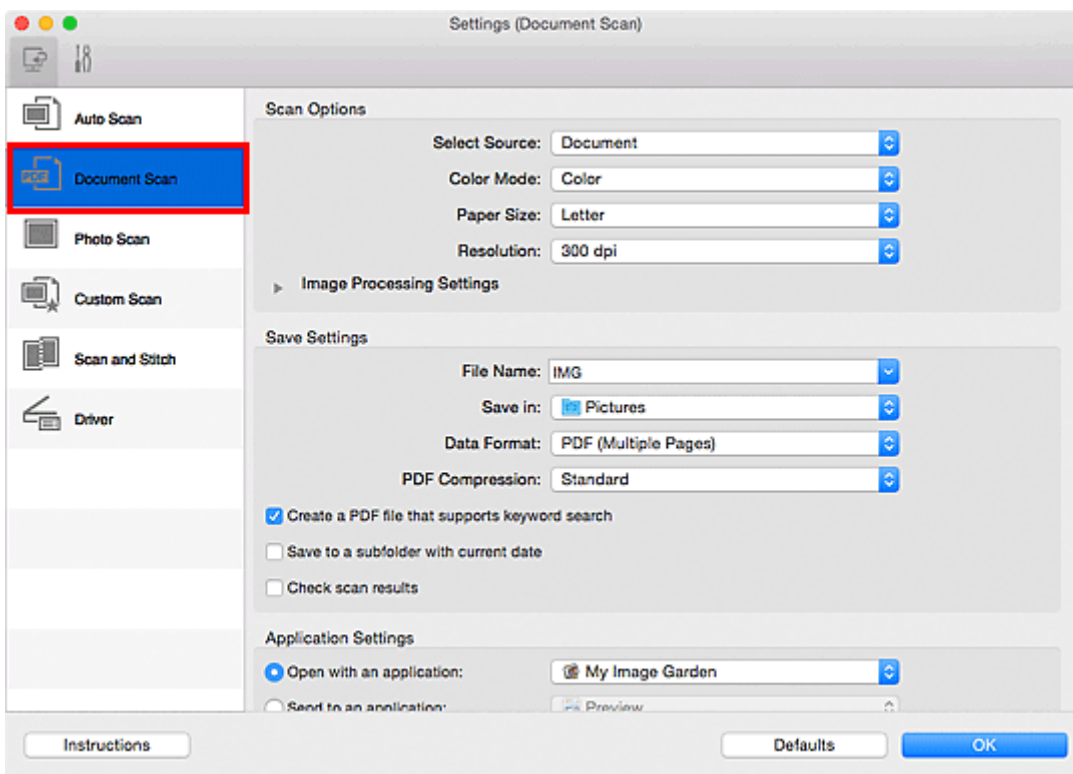

►►► Note

- For **Resolution**, only **300 dpi** or **400 dpi** can be set when **Start OCR** is selected in **Application Settings**.

4. Select **Start OCR** for **Application Settings**, then select the application in which you want to display the result.

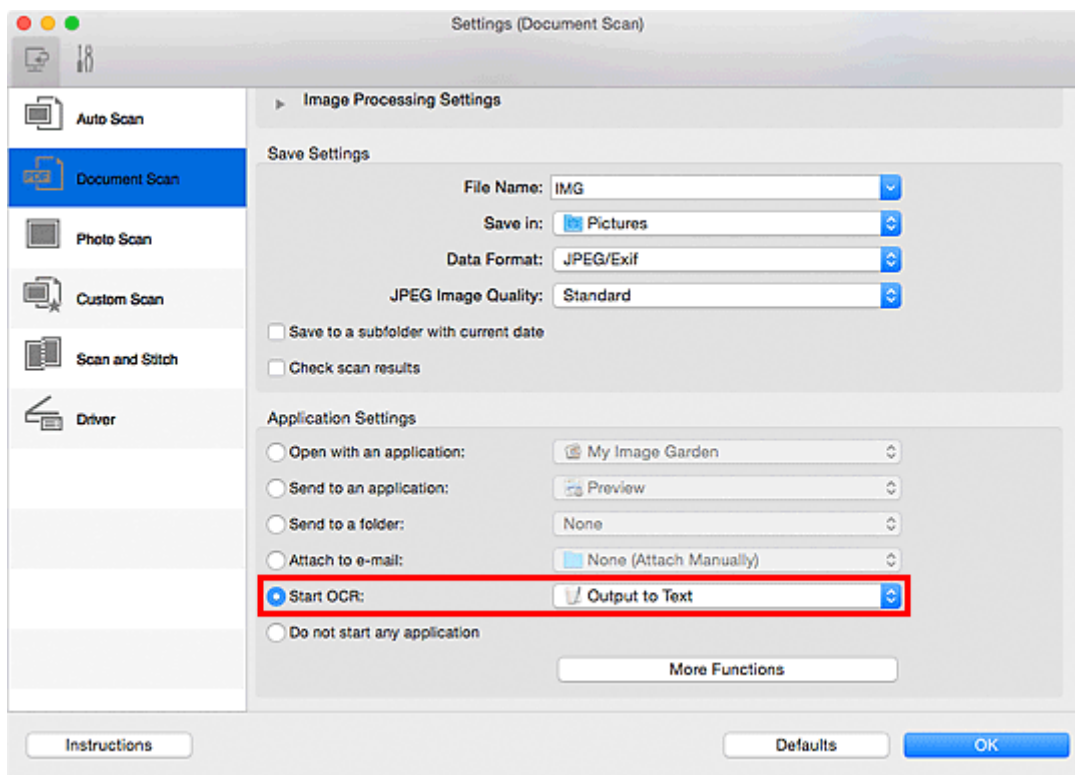

►►► Note

- If a compatible application is not installed, the text in the image is extracted and appears in your text editor.
Text to be displayed is based on **Document Language** in the [Settings \(General Settings\) dialog](#). Select the language you want to extract in **Document Language** and scan.
- You can add the application from the pop-up menu.

5. Click **OK**.

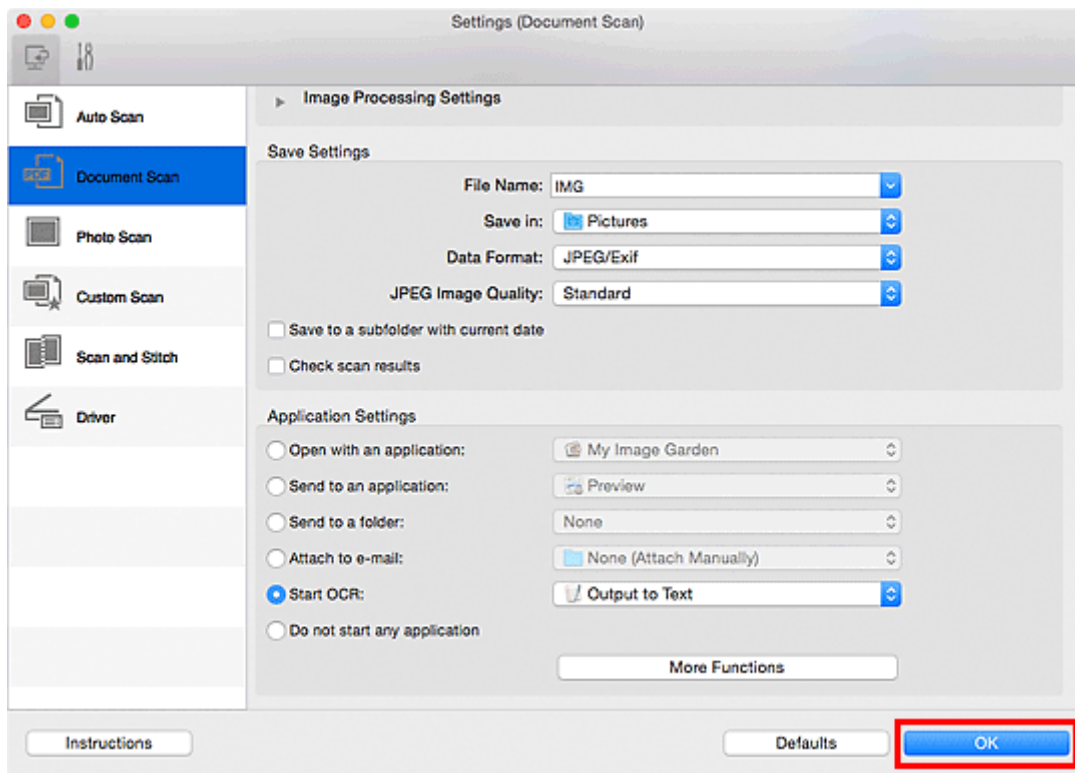

The IJ Scan Utility main screen appears.

►►► Note

- Refer to the following pages for details on the setting items in the Settings dialog.

- [Settings \(Document Scan\) Dialog](#)
- [Settings \(Custom Scan\) Dialog](#)
- [Settings \(Driver\) Dialog](#)

6. Click **Document**.

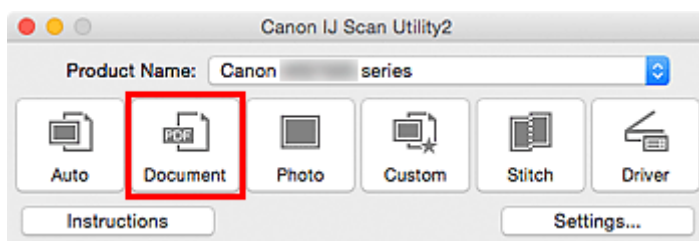

Scanning starts.

When scanning is completed, the scanned images are saved according to the settings, and the extracted text appears in the specified application.

►►► Note

- Click **Cancel** to cancel the scan.
- Text displayed in your text editor is for guidance only. Text in the image of the following types of documents may not be detected correctly.
 - Documents containing text with font size outside the range of 8 points to 40 points (at 300 dpi)
 - Slanted documents

- Documents placed upside down or documents with text in the wrong orientation (rotated characters)
 - Documents containing special fonts, effects, italics, or hand-written text
 - Documents with narrow line spacing
 - Documents with colors in the background of text
 - Documents containing multiple languages
-

IJ Scan Utility Screens

- ▶ **IJ Scan Utility Main Screen**
- ▶ **Settings Dialog**
 - **Settings (Auto Scan) Dialog**
 - **Settings (Document Scan) Dialog**
 - **Settings (Photo Scan) Dialog**
 - **Settings (Custom Scan) Dialog**
 - **Settings (Scan and Stitch) Dialog**
 - **Settings (Driver) Dialog**
 - **Settings (General Settings) Dialog**
- ▶ **Save Settings Dialog**
- ▶ **Image Stitch Window**

IJ Scan Utility Main Screen

From the **Go** menu of Finder, select **Applications**, then double-click the **Canon Utilities** folder, **IJ Scan Utility** folder, and then **Canon IJ Scan Utility2** icon to start IJ Scan Utility.

You can complete from scanning to saving at one time by simply clicking the corresponding icon.

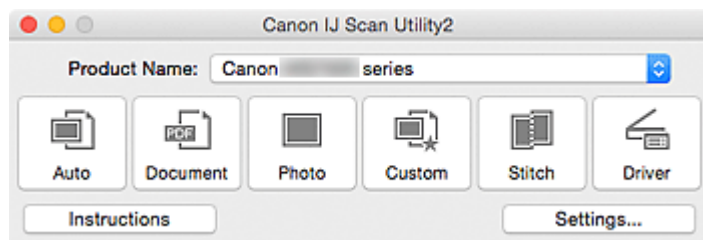

Product Name

Displays the name of the product that IJ Scan Utility is currently set to use.

If the displayed product is not the one you want to use, select the desired product from the list.

Auto

Detects the item type automatically and saves them to a computer. The data format for saving will also be set automatically.

Save settings and the response after scanning can be specified in the [Settings \(Auto Scan\) dialog](#).

Document

Scans items as documents and saves them to a computer.

Scan/save settings and the response after scanning can be specified in the [Settings \(Document Scan\) dialog](#).

Photo

Scans items as photos and saves them to a computer.

Scan/save settings and the response after scanning can be specified in the [Settings \(Photo Scan\) dialog](#).

Custom

Scans items with your favorite settings and saves the images to a computer. The item type can be automatically detected.

Scan/save settings and the response after scanning can be specified in the [Settings \(Custom Scan\) dialog](#).

Stitch

Displays the **Image Stitch** window in which you can scan the left and right halves of an item larger than the platen and combine the scanned images back into one image.

Scan/save settings and the response after scanning can be specified in the [Settings \(Scan and Stitch\) dialog](#).

Driver

Allows you to make image corrections and color adjustments when scanning.

Scan/save settings and the response after scanning can be specified in the [Settings \(Driver\) dialog](#).



Instructions

Opens this guide.

Settings...

Displays the [Settings dialog](#) in which you can specify the scan/save settings and the response after scanning.

Settings Dialog

There are two tabs in the Settings dialog:  (Scanning from a Computer) and  (General Settings). When you click a tab, the view in the red frame switches and you can make advanced settings to functions on each tab.

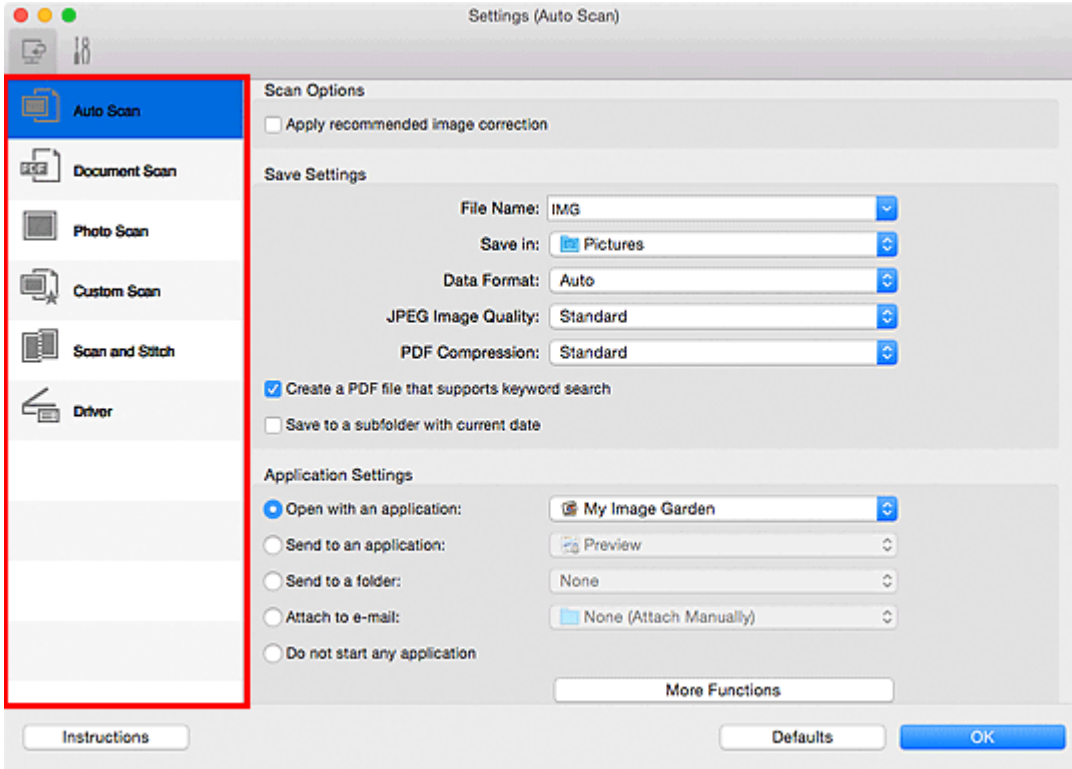

(Scanning from a Computer) Tab

You can specify how to respond when scanning from IJ Scan Utility or My Image Garden.

- [Settings \(Auto Scan\) Dialog](#)
- [Settings \(Document Scan\) Dialog](#)
- [Settings \(Photo Scan\) Dialog](#)
- [Settings \(Custom Scan\) Dialog](#)
- [Settings \(Scan and Stitch\) Dialog](#)
- [Settings \(Driver\) Dialog](#)

(General Settings) Tab

You can set the product to use, file size restriction on e-mail attachment, language to detect text in images, and folder in which to save images temporarily.

- [Settings \(General Settings\) Dialog](#)

Settings (Auto Scan) Dialog

Click **Auto Scan** on the  (Scanning from a Computer) tab to display the **Settings (Auto Scan)** dialog.

In the **Settings (Auto Scan)** dialog, you can make advanced scan settings to scan by automatically detecting the item type.

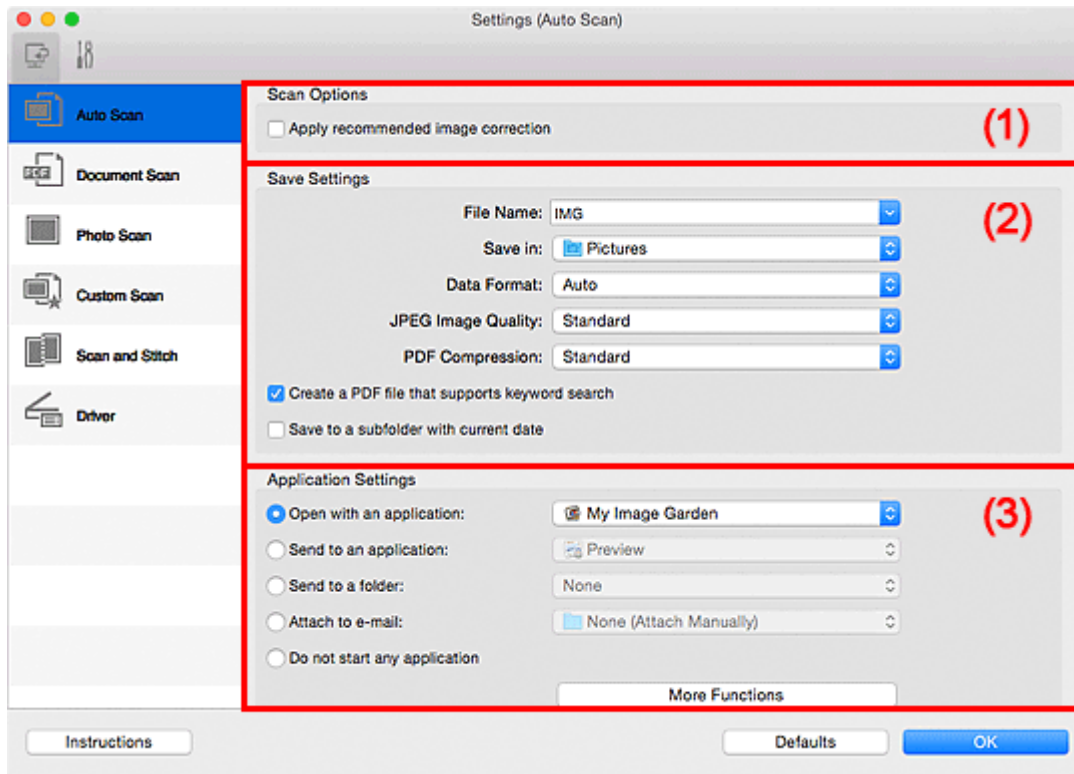

- [\(1\) Scan Options Area](#)
- [\(2\) Save Settings Area](#)
- [\(3\) Application Settings Area](#)

»»» Important

- When the Settings dialog is displayed from My Image Garden, the setting items for **Application Settings** do not appear.

Supported Items

Photos, postcards, business cards, magazines, newspapers, documents, and BD/DVD/CD.

»»» Important

- To scan the following types of items, specify the item type and size in the **Settings (Document Scan)** dialog, **Settings (Photo Scan)** dialog, or **Settings (Custom Scan)** dialog, then click **Photo**, **Document**, or **Custom** in the IJ Scan Utility main screen. You cannot scan correctly with **Auto**.
 - A4 size photos
 - Text documents smaller than 2L (5 inches x 7 inches) (127 mm x 178 mm), such as paperback pages with the spine cut off
 - Items printed on thin white paper
 - Long narrow items such as panoramic photos

- Reflective disc labels may not be scanned as expected.
 - Place items to be scanned on the platen correctly. Otherwise, items may not be scanned correctly.
- Refer to "[Positioning Originals \(Scanning from Computer\)](#)" for how to place items.

▶▶▶ Note

- To reduce moire in scans, set **Select Source** to **Magazine** in the **Settings (Document Scan)** dialog or **Settings (Custom Scan)** dialog, then click **Document** or **Custom** in the IJ Scan Utility main screen.

(1) Scan Options Area

Apply recommended image correction

Applies suitable corrections automatically based on the item type.

▶▶▶ Important

- The color tone may differ from the source image due to corrections. In that case, deselect the checkbox and scan.

▶▶▶ Note

- Scanning takes longer than usual when you enable this function.

(2) Save Settings Area

File Name

Enter the file name of the image to be saved. When you save a file, the date and four digits are appended to the set file name in the "_20XX0101_0001" format.

▶▶▶ Note

- When you select the **Save to a subfolder with current date** checkbox, the date and four digits are appended to the set file name.

Save in

Displays the folder in which to save the scanned images. To add a folder, select **Add...** from the pop-up menu, then click (Plus) in the displayed dialog and specify the destination folder.

The default save folder is the **Pictures** folder.

▶▶▶ Important

- When the Settings dialog is displayed from My Image Garden, this option does not appear.

Data Format

Auto is selected. The following data formats are automatically applied according to the item type when saving.

- Photos, postcards, BD/DVD/CD, and business cards: JPEG
- Magazines, newspapers, and documents: PDF

▶▶▶ Important

- The save format may differ depending on how you place the item.

JPEG Image Quality

You can specify the image quality of JPEG files.

PDF Compression

Select the compression type for saving PDF files.

Standard

It is recommended that you normally select this setting.

High

Compresses the file size when saving, allowing you to reduce the load on your network/server.

Create a PDF file that supports keyword search

Select this checkbox to convert text in images into text data and create PDF files that support keyword search.

»» Note

- PDF files that are searchable in the language selected in **Document Language** on the  (General Settings) tab of the Settings dialog are created.

Save to a subfolder with current date

Select this checkbox to create a current date folder in the folder specified in **Save in** and save scanned images in it. The folder will be created with a name such as "20XX_01_01" (Year_Month_Date).

If this checkbox is not selected, files are saved directly in the folder specified in **Save in**.

(3) Application Settings Area

Open with an application

Select this when you want to enhance or correct the scanned images.

You can specify the application from the pop-up menu.

Send to an application

Select this when you want to use the scanned images as they are in an application that allows you to browse or organize images.

You can specify the application from the pop-up menu.

Send to a folder

Select this when you also want to save the scanned images to a folder other than the one specified in **Save in**.

You can specify the folder from the pop-up menu.

Attach to e-mail

Select this when you want to send e-mails with the scanned images attached.

You can specify the e-mail client you want to start from the pop-up menu.

Do not start any application

Saves to the folder specified in **Save in**.

▶▶▶ Note

- To add an application or folder to the pop-up menu, select **Add...** from the pop-up menu, then click  (Plus) in the displayed dialog and specify the application or folder.

Instructions

Opens this guide.

Defaults

You can restore the settings in the displayed screen to the default settings.

Settings (Document Scan) Dialog

Click **Document Scan** on the  (Scanning from a Computer) tab to display the **Settings (Document Scan)** dialog.

In the **Settings (Document Scan)** dialog, you can make advanced scan settings to scan items as documents.

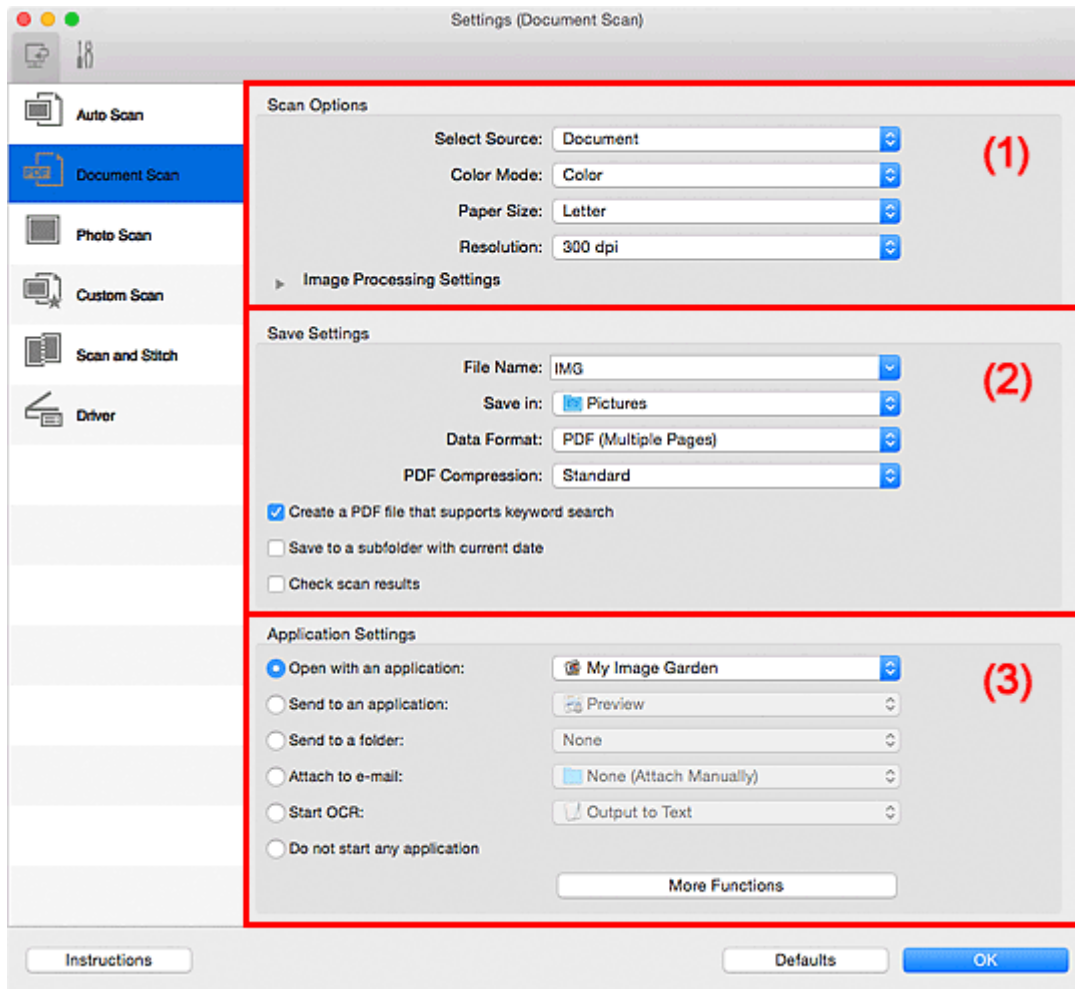

- [\(1\) Scan Options Area](#)
- [\(2\) Save Settings Area](#)
- [\(3\) Application Settings Area](#)

➤➤➤ Important

- When the Settings dialog is displayed from the Scan screen of My Image Garden, the setting items for **Application Settings** do not appear.

(1) Scan Options Area

Select Source

Select the type of item to be scanned.

- Scanning documents: **Document**
- Scanning magazines: **Magazine**

Color Mode

Select the color mode in which to scan the item.

Paper Size

Select the size of the item to be scanned.

When you select **Custom**, a screen in which you can specify the paper size appears. Select a **Unit**, then enter the **Width** and **Height**, and then click **OK**.

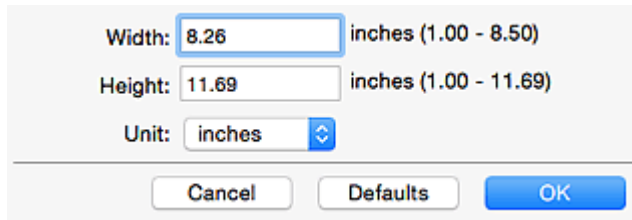

Width: inches (1.00 - 8.50)
Height: inches (1.00 - 11.69)
Unit: 

»»» Note

- Click **Defaults** to restore the specified settings to the default settings.

Resolution

Select the resolution of the item to be scanned.

The higher the resolution (value), the more detail in your image.

■ [Resolution](#)

»»» Note

- Only **300 dpi** or **400 dpi** can be set when **Start OCR** is selected in **Application Settings**.

Image Processing Settings

Click  (Right Arrow) to set the following.

»»» Note

- When **Color Mode** is **Black and White**, only **Reduce gutter shadow**, **Correct slanted text document**, and **Detect the orientation of text document and rotate image** appear.

Apply Auto Document Fix

Select this checkbox to sharpen text in a document or magazine for better readability.

»»» Important

- The color tone may differ from the source image due to corrections. In that case, deselect the checkbox and scan.

»»» Note

- Scanning takes longer than usual when you enable this function.

Sharpen outline

Emphasizes the outline of the subjects to sharpen the image.

Reduce show-through

Sharpens text in an item or reduces show-through in newspapers, etc.

Reduce moire

Reduces moire patterns.

Printed materials are displayed as a collection of fine dots. "Moire" is a phenomenon where uneven gradation or a stripe pattern appears when such photos or pictures printed with fine dots are scanned.

►► Note

- Scanning takes longer than usual when you enable **Reduce moire**.

Reduce gutter shadow

Reduces gutter shadows that appear between pages when scanning open booklets.

►► Note

- Click **Driver** in the IJ Scan Utility main screen and scan to correct gutter shadows when scanning non-standard size items or specified areas.
Refer to "[Gutter Correction](#)" for details.

Correct slanted text document

Detects the scanned text and corrects the angle (within -0.1 to -10 degrees or +0.1 to +10 degrees) of the document.

►► Important

- The following types of documents may not be corrected properly since the text cannot be detected correctly.
 - Documents in which the text lines are inclined more than 10 degrees or the angles vary by line
 - Documents containing both vertical and horizontal text
 - Documents with extremely large or small fonts
 - Documents with small amount of text
 - Documents containing figures/images
 - Hand-written text
 - Documents containing both vertical and horizontal lines (tables)

►► Note

- Scanning takes longer than usual when you enable **Correct slanted text document**.

Detect the orientation of text document and rotate image

Automatically rotates the image to the correct orientation by detecting the orientation of text in the scanned document.

►► Important

- Only text documents written in the language selected from **Document Language** in the [Settings \(General Settings\) dialog](#) are supported.
- The orientation may not be detected for the following types of settings or documents since the text cannot be detected correctly.
 - Resolution is outside the range of 300 dpi to 600 dpi
 - Font size is outside the range of 8 points to 48 points
 - Documents containing special fonts, effects, italics, or hand-written text
 - Documents with patterned backgrounds

In that case, select the **Check scan results** checkbox and rotate the image in the [Save Settings dialog](#).

(2) Save Settings Area

File Name

Enter the file name of the image to be saved. When you save a file, the date and four digits are appended to the set file name in the "_20XX0101_0001" format.

▶▶▶ Note

- When you select the **Save to a subfolder with current date** checkbox, the date and four digits are appended to the set file name.

Save in

Displays the folder in which to save the scanned images. To add a folder, select **Add...** from the pop-up menu, then click (Plus) in the displayed dialog and specify the destination folder.

The default save folder is the **Pictures** folder.

▶▶▶ Important

- When the Settings dialog is displayed from My Image Garden, this option does not appear.

Data Format

Select the data format in which to save the scanned images.

You can select **JPEG/Exif**, **TIFF**, **PNG**, **PDF**, or **PDF (Multiple Pages)**.

▶▶▶ Important

- You cannot select **JPEG/Exif** when **Color Mode** is **Black and White**.
- When **Start OCR** is selected in **Application Settings**, you cannot select **PDF** or **PDF (Multiple Pages)**.

PDF Compression

Select the compression type for saving PDF files.

Standard

It is recommended that you normally select this setting.

High

Compresses the file size when saving, allowing you to reduce the load on your network/server.

▶▶▶ Important

- This appears only when **PDF** or **PDF (Multiple Pages)** is selected in **Data Format**.
- When **Black and White** is selected in **Color Mode**, this option does not appear.

JPEG Image Quality

You can specify the image quality of JPEG files.

▶▶▶ Important

- This appears only when **JPEG/Exif** is selected in **Data Format**.

Create a PDF file that supports keyword search

Select this checkbox to convert text in images into text data and create PDF files that support keyword search.

►►► Important

- This appears only when **PDF** or **PDF (Multiple Pages)** is selected in **Data Format**.

►►► Note

- PDF files that are searchable in the language selected in **Document Language** on the  (General Settings) tab of the Settings dialog are created.

Save to a subfolder with current date

Select this checkbox to create a current date folder in the folder specified in **Save in** and save scanned images in it. The folder will be created with a name such as "20XX_01_01" (Year_Month_Date).

If this checkbox is not selected, files are saved directly in the folder specified in **Save in**.

Check scan results

Displays the [Save Settings dialog](#) after scanning.

►►► Important

- When the Settings dialog is displayed from My Image Garden, this option does not appear.

(3) Application Settings Area

Open with an application

Select this when you want to enhance or correct the scanned images.

You can specify the application from the pop-up menu.

Send to an application

Select this when you want to use the scanned images as they are in an application that allows you to browse or organize images.

You can specify the application from the pop-up menu.

Send to a folder

Select this when you also want to save the scanned images to a folder other than the one specified in **Save in**.

You can specify the folder from the pop-up menu.

Attach to e-mail

Select this when you want to send e-mails with the scanned images attached.

You can specify the e-mail client you want to start from the pop-up menu.

Start OCR

Select this when you want to convert text in the scanned image into text data.

You can specify the application from the pop-up menu.

Do not start any application

Saves to the folder specified in **Save in**.

▶▶▶ Note

- To add an application or folder to the pop-up menu, select **Add...** from the pop-up menu, then click  (Plus) in the displayed dialog and specify the application or folder.

Instructions

Opens this guide.

Defaults

You can restore the settings in the displayed screen to the default settings.

Settings (Photo Scan) Dialog

Click **Photo Scan** on the  (Scanning from a Computer) tab to display the **Settings (Photo Scan)** dialog.

In the **Settings (Photo Scan)** dialog, you can make advanced scan settings to scan items as photos.

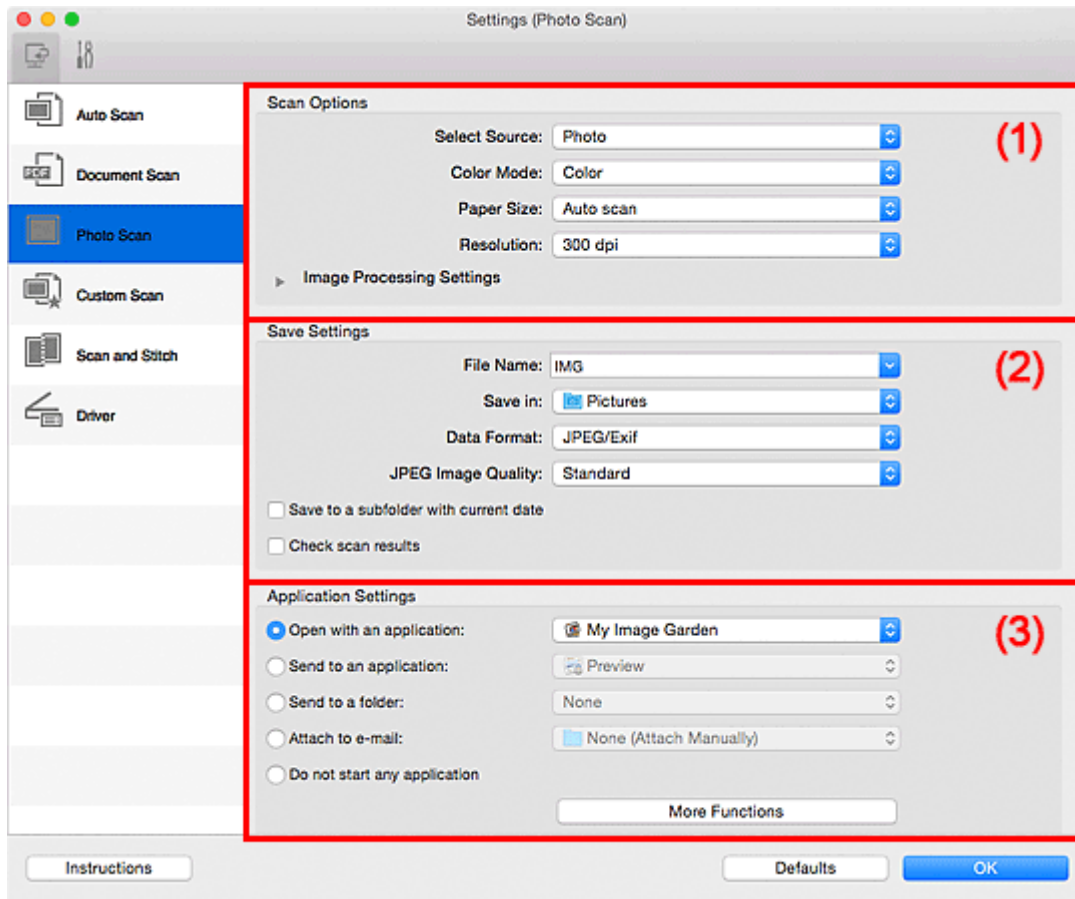

- [\(1\) Scan Options Area](#)
- [\(2\) Save Settings Area](#)
- [\(3\) Application Settings Area](#)

»»» Important

- When the Settings dialog is displayed from My Image Garden, the setting items for **Application Settings** do not appear.

(1) Scan Options Area

Select Source

Photo is selected.

Color Mode

Select the color mode in which to scan the item.

Paper Size

Select the size of the item to be scanned.

When you select **Custom**, a screen in which you can specify the paper size appears. Select a **Unit**, then enter the **Width** and **Height**, and then click **OK**.

Width:	<input type="text" value="8.26"/>	inches (1.00 - 8.50)
Height:	<input type="text" value="11.69"/>	inches (1.00 - 11.69)
Unit:	<input type="text" value="inches"/>	<input type="button" value="v"/>
<input type="button" value="Cancel"/> <input type="button" value="Defaults"/> <input type="button" value="OK"/>		

»»» Note

- Click **Defaults** to restore the specified settings to the default settings.

Resolution

Select the resolution of the item to be scanned.

The higher the resolution (value), the more detail in your image.

■ [Resolution](#)

Image Processing Settings

Click  (Right Arrow) to set the following.

»»» Important

- When **Color Mode** is **Black and White**, **Image Processing Settings** is not available.

Sharpen outline

Emphasizes the outline of the subjects to sharpen the image.

(2) Save Settings Area

File Name

Enter the file name of the image to be saved. When you save a file, the date and four digits are appended to the set file name in the "_20XX0101_0001" format.

»»» Note

- When you select the **Save to a subfolder with current date** checkbox, the date and four digits are appended to the set file name.

Save in

Displays the folder in which to save the scanned images. To add a folder, select **Add...** from the pop-up menu, then click  (Plus) in the displayed dialog and specify the destination folder.

The default save folder is the **Pictures** folder.

»»» Important

- When the Settings dialog is displayed from My Image Garden, this option does not appear.

Data Format

Select the data format in which to save the scanned images.

You can select **JPEG/Exif**, **TIFF**, or **PNG**.

»»» Important

- You cannot select **JPEG/Exif** when **Color Mode** is **Black and White**.

JPEG Image Quality

You can specify the image quality of JPEG files.

»» Important

- This appears only when **JPEG/Exif** is selected in **Data Format**.

Save to a subfolder with current date

Select this checkbox to create a current date folder in the folder specified in **Save in** and save scanned images in it. The folder will be created with a name such as "20XX_01_01" (Year_Month_Date).

If this checkbox is not selected, files are saved directly in the folder specified in **Save in**.

Check scan results

Displays the [Save Settings dialog](#) after scanning.

»» Important

- When the Settings dialog is displayed from My Image Garden, this option does not appear.

(3) Application Settings Area

Open with an application

Select this when you want to enhance or correct the scanned images.

You can specify the application from the pop-up menu.

Send to an application

Select this when you want to use the scanned images as they are in an application that allows you to browse or organize images.

You can specify the application from the pop-up menu.

Send to a folder

Select this when you also want to save the scanned images to a folder other than the one specified in **Save in**.

You can specify the folder from the pop-up menu.

Attach to e-mail

Select this when you want to send e-mails with the scanned images attached.

You can specify the e-mail client you want to start from the pop-up menu.

Do not start any application

Saves to the folder specified in **Save in**.

»» Note

- To add an application or folder to the pop-up menu, select **Add...** from the pop-up menu, then click



(Plus) in the displayed dialog and specify the application or folder.

Instructions

Opens this guide.

Defaults

You can restore the settings in the displayed screen to the default settings.

Settings (Custom Scan) Dialog

Click **Custom Scan** on the  (Scanning from a Computer) tab to display the **Settings (Custom Scan)** dialog.

In the **Settings (Custom Scan)** dialog, you can make advanced scan settings to scan according to your preference.

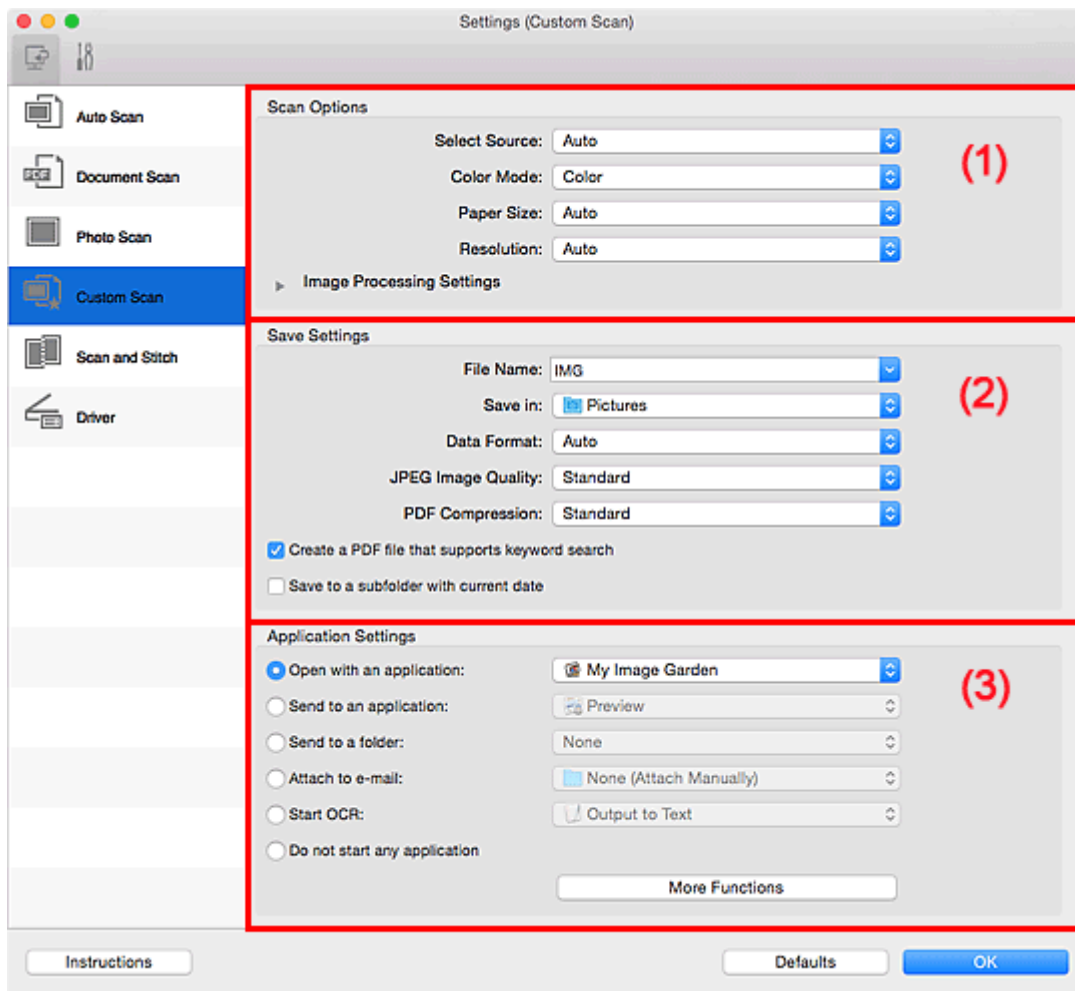

- [\(1\) Scan Options Area](#)
- [\(2\) Save Settings Area](#)
- [\(3\) Application Settings Area](#)

Important

- When the Settings dialog is displayed from the Scan screen of My Image Garden, the setting items for **Application Settings** do not appear.

(1) Scan Options Area

Select Source

Select the type of item to be scanned. Select **Auto** to detect the item type automatically and to set **Color Mode**, **Paper Size**, and **Resolution** automatically as well.

►►► Important

- Item types supported by **Auto** are photos, postcards, business cards, magazines, newspapers, documents, and BD/DVD/CD.
 - To scan the following types of items, specify the item type or size. You cannot scan correctly with **Auto**.
 - A4 size photos
 - Text documents smaller than 2L (5 inches x 7 inches) (127 mm x 178 mm), such as paperback pages with the spine cut off
 - Items printed on thin white paper
 - Long narrow items such as panoramic photos
 - Reflective disc labels may not be scanned as expected.
 - Place items correctly according to the type of item to be scanned. Otherwise, items may not be scanned correctly.
- Refer to "[Positioning Originals \(Scanning from Computer\)](#)" for how to place items.

►►► Note

- To convert text in the image into text data after scanning, specify **Select Source** instead of selecting **Auto**.
- To reduce moire, set **Select Source** to **Magazine** or select the **Reduce moire** checkbox in **Image Processing Settings**.

Color Mode

Select the color mode in which to scan the item.

►►► Note

- Only **Color** is available when **Select Source** is **Auto**.

Paper Size

Select the size of the item to be scanned.

When you select **Custom**, a screen in which you can specify the paper size appears. Select a **Unit**, then enter the **Width** and **Height**, and then click **OK**.

Width: inches (1.00 - 8.50)
Height: inches (1.00 - 11.69)
Unit: 

►►► Note

- Only **Auto** is available when **Select Source** is **Auto**.
- Click **Defaults** in the screen in which you can specify the paper size to restore the specified settings to the default settings.

Resolution

Select the resolution of the item to be scanned.

The higher the resolution (value), the more detail in your image.

■ Resolution

»»» Note

- Only **Auto** is available when **Select Source** is **Auto**.
- Only **300 dpi** or **400 dpi** can be set when **Start OCR** is selected in **Application Settings**.

Image Processing Settings

Click  (Right Arrow) to set the following. Available setting items vary by **Select Source**.

- **When Select Source is Auto:**

Apply recommended image correction

Applies suitable corrections automatically based on the item type.

»»» Important

- The color tone may differ from the source image due to corrections. In that case, deselect the checkbox and scan.

»»» Note

- Scanning takes longer than usual when you enable this function.

- **When Select Source is Photo:**

»»» Important

- When **Color Mode** is **Black and White**, **Image Processing Settings** is not available.

Sharpen outline

Emphasizes the outline of the subjects to sharpen the image.

- **When Select Source is Magazine or Document:**

»»» Note

- When **Color Mode** is **Black and White**, only **Reduce gutter shadow**, **Correct slanted text document**, and **Detect the orientation of text document and rotate image** appear.

Apply Auto Document Fix

Select this checkbox to sharpen text in a document or magazine for better readability.

»»» Important

- The color tone may differ from the source image due to corrections. In that case, deselect the checkbox and scan.

»»» Note

- Scanning takes longer than usual when you enable this function.

Sharpen outline

Emphasizes the outline of the subjects to sharpen the image.

Reduce show-through

Sharpens text in an item or reduces show-through in newspapers, etc.

Reduce moire

Reduces moire patterns.

Printed materials are displayed as a collection of fine dots. "Moire" is a phenomenon where uneven gradation or a stripe pattern appears when such photos or pictures printed with fine dots are scanned.

▶▶▶ Note

- Scanning takes longer than usual when you enable **Reduce moire**.

Reduce gutter shadow

Reduces gutter shadows that appear between pages when scanning open booklets.

▶▶▶ Note

- Click **Driver** in the IJ Scan Utility main screen and scan to correct gutter shadows when scanning non-standard size items or specified areas.
Refer to "[Gutter Correction](#)" for details.

Correct slanted text document

Detects the scanned text and corrects the angle (within -0.1 to -10 degrees or +0.1 to +10 degrees) of the document.

▶▶▶ Important

- The following types of documents may not be corrected properly since the text cannot be detected correctly.
 - Documents in which the text lines are inclined more than 10 degrees or the angles vary by line
 - Documents containing both vertical and horizontal text
 - Documents with extremely large or small fonts
 - Documents with small amount of text
 - Documents containing figures/images
 - Hand-written text
 - Documents containing both vertical and horizontal lines (tables)

▶▶▶ Note

- Scanning takes longer than usual when you enable **Correct slanted text document**.

Detect the orientation of text document and rotate image

Automatically rotates the image to the correct orientation by detecting the orientation of text in the scanned document.

▶▶▶ Important

- Only text documents written in languages that can be selected from **Document Language** in the [Settings \(General Settings\) dialog](#) are supported.
- The orientation may not be detected for the following types of settings or documents since the text cannot be detected correctly.
 - Resolution is outside the range of 300 dpi to 600 dpi
 - Font size is outside the range of 8 points to 48 points

- Documents containing special fonts, effects, italics, or hand-written text
- Documents with patterned backgrounds

In that case, select the **Check scan results** checkbox and rotate the image in the [Save Settings dialog](#).

(2) Save Settings Area

File Name

Enter the file name of the image to be saved. When you save a file, the date and four digits are appended to the set file name in the "_20XX0101_0001" format.

►►► Note

- When you select the **Save to a subfolder with current date** checkbox, the date and four digits are appended to the set file name.

Save in

Displays the folder in which to save the scanned images. To add a folder, select **Add...** from the pop-up menu, then click (Plus) in the displayed dialog and specify the destination folder.

The default save folder is the **Pictures** folder.

►►► Important

- When the Settings dialog is displayed from My Image Garden, this option does not appear.

Data Format

Select the data format in which to save the scanned images.

You can select **JPEG/Exif**, **TIFF**, **PNG**, **PDF**, **PDF (Multiple Pages)**, or **Auto**.

►►► Important

- When **Auto** is selected, the save format may differ depending on how you place the item.
 - [Positioning Originals \(Scanning from Computer\)](#)
- You cannot select **JPEG/Exif** when **Color Mode** is **Black and White**.
- When **Start OCR** is selected in **Application Settings**, you cannot select **PDF**, **PDF (Multiple Pages)**, or **Auto**.

►►► Note

- **Auto** appears only when **Auto** is selected for **Select Source**.

JPEG Image Quality

You can specify the image quality of JPEG files.

►►► Important

- This appears only when **JPEG/Exif** or **Auto** is selected in **Data Format**.

PDF Compression

Select the compression type for saving PDF files.

Standard

It is recommended that you normally select this setting.

High

Compresses the file size when saving, allowing you to reduce the load on your network/server.

»»» Important

- This appears only when **PDF**, **PDF (Multiple Pages)**, or **Auto** is selected in **Data Format**.
- When **Black and White** is selected in **Color Mode**, this option does not appear.

Create a PDF file that supports keyword search

Select this checkbox to convert text in images into text data and create PDF files that support keyword search.

»»» Important

- This appears only when **PDF**, **PDF (Multiple Pages)**, or **Auto** is selected in **Data Format**.

»»» Note

- PDF files that are searchable in the language selected in **Document Language** on the  (General Settings) tab of the Settings dialog are created.

Save to a subfolder with current date

Select this checkbox to create a current date folder in the folder specified in **Save in** and save scanned images in it. The folder will be created with a name such as "20XX_01_01" (Year_Month_Date).

If this checkbox is not selected, files are saved directly in the folder specified in **Save in**.

Check scan results

Displays the [Save Settings dialog](#) after scanning.

»»» Important

- This does not appear when **Select Source** is **Auto**.
- When the Settings dialog is displayed from My Image Garden, this option does not appear.

(3) Application Settings Area

Open with an application

Select this when you want to enhance or correct the scanned images.

You can specify the application from the pop-up menu.

Send to an application

Select this when you want to use the scanned images as they are in an application that allows you to browse or organize images.

You can specify the application from the pop-up menu.

Send to a folder

Select this when you also want to save the scanned images to a folder other than the one specified in **Save in**.

You can specify the folder from the pop-up menu.

Attach to e-mail

Select this when you want to send e-mails with the scanned images attached.

You can specify the e-mail client you want to start from the pop-up menu.

Start OCR

Select this when you want to convert text in the scanned image into text data.

You can specify the application from the pop-up menu.

Do not start any application

Saves to the folder specified in **Save in**.

▶▶ Note

- To add an application or folder to the pop-up menu, select **Add...** from the pop-up menu, then click



(Plus) in the displayed dialog and specify the application or folder.

Instructions

Opens this guide.

Defaults

You can restore the settings in the displayed screen to the default settings.

Settings (Scan and Stitch) Dialog

Click **Scan and Stitch** on the  (Scanning from a Computer) tab to display the **Settings (Scan and Stitch)** dialog.

In the **Settings (Scan and Stitch)** dialog, you can make advanced scan settings for scanning items larger than the platen.

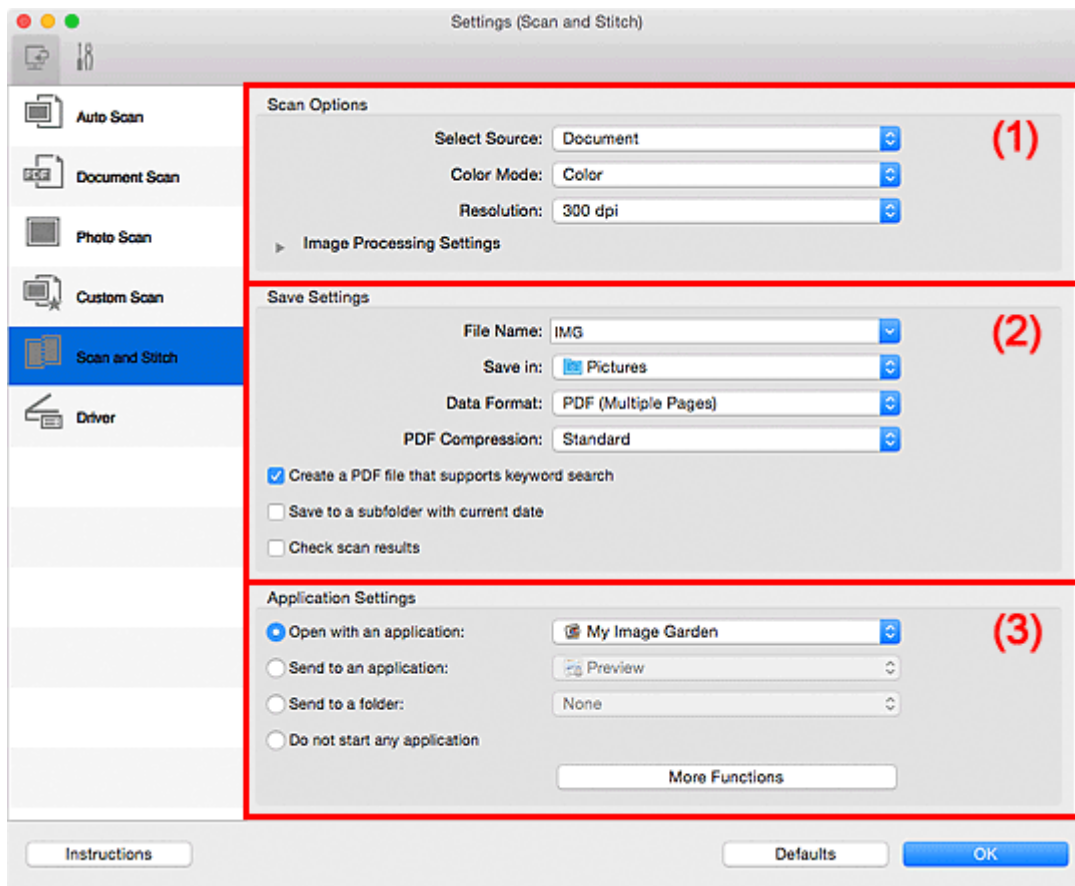

- [\(1\) Scan Options Area](#)
- [\(2\) Save Settings Area](#)
- [\(3\) Application Settings Area](#)

►►► Important

- When the Settings dialog is displayed from the Scan screen of My Image Garden, the setting items for **Application Settings** do not appear.

(1) Scan Options Area

Select Source

Select the type of item to be scanned.

- Scanning photos: **Photo**
- Scanning documents: **Document**
- Scanning magazines: **Magazine**

▶▶▶ Note

- To reduce moire, set **Select Source** to **Magazine** or select the **Reduce moire** checkbox in **Image Processing Settings**.

Color Mode

Select the color mode in which to scan the item.

Resolution

Select the resolution of the item to be scanned.

The higher the resolution (value), the more detail in your image.

■ [Resolution](#)

Image Processing Settings

Click  (Right Arrow) to set the following. Available setting items vary by **Select Source**.

▶▶▶ Important

- When **Color Mode** is **Black and White**, **Image Processing Settings** is not available.

- **When Select Source is Photo:**

Sharpen outline

Emphasizes the outline of the subjects to sharpen the image.

- **When Select Source is Magazine or Document:**

Sharpen outline

Emphasizes the outline of the subjects to sharpen the image.

Reduce show-through

Sharpens text in an item or reduces show-through in newspapers, etc.

Reduce moire

Reduces moire patterns.

Printed materials are displayed as a collection of fine dots. "Moire" is a phenomenon where uneven gradation or a stripe pattern appears when such photos or pictures printed with fine dots are scanned.

▶▶▶ Note

- Scanning takes longer than usual when you enable **Reduce moire**.

(2) Save Settings Area

File Name

Enter the file name of the image to be saved. When you save a file, the date and four digits are appended to the set file name in the "_20XX0101_0001" format.

▶▶▶ Note

- When you select the **Save to a subfolder with current date** checkbox, the date and four digits are appended to the set file name.

Save in

Displays the folder in which to save the scanned images. To add a folder, select **Add...** from the pop-up menu, then click  (Plus) in the displayed dialog and specify the destination folder.

The default save folder is the **Pictures** folder.

»»» Important

- When the Settings dialog is displayed from My Image Garden, this option does not appear.

Data Format

Select the data format in which to save the scanned images.

You can select **JPEG/Exif**, **TIFF**, **PNG**, **PDF**, or **PDF (Multiple Pages)**.

»»» Important

- You cannot select **JPEG/Exif** when **Color Mode** is **Black and White**.

PDF Compression

Select the compression type for saving PDF files.

Standard

It is recommended that you normally select this setting.

High

Compresses the file size when saving, allowing you to reduce the load on your network/server.

»»» Important

- This appears only when **PDF** or **PDF (Multiple Pages)** is selected in **Data Format**.
- When **Black and White** is selected in **Color Mode**, this option does not appear.

Create a PDF file that supports keyword search

Select this checkbox to convert text in images into text data and create PDF files that support keyword search.

»»» Important

- This appears only when **PDF** or **PDF (Multiple Pages)** is selected in **Data Format**.

»»» Note

- PDF files that are searchable in the language selected in **Document Language** on the  (General Settings) tab of the Settings dialog are created.

JPEG Image Quality

You can specify the image quality of JPEG files.

»»» Important

- This appears only when **JPEG/Exif** is selected in **Data Format**.

Save to a subfolder with current date

Select this checkbox to create a current date folder in the folder specified in **Save in** and save scanned images in it. The folder will be created with a name such as "20XX_01_01" (Year_Month_Date).

If this checkbox is not selected, files are saved directly in the folder specified in **Save in**.

Check scan results

Displays the [Save Settings dialog](#) after scanning.

►►► Important

- When the Settings dialog is displayed from My Image Garden, this option does not appear.

(3) Application Settings Area

Open with an application

Select this when you want to enhance or correct the scanned images.

You can specify the application from the pop-up menu.

Send to an application

Select this when you want to use the scanned images as they are in an application that allows you to browse or organize images.

You can specify the application from the pop-up menu.

Send to a folder

Select this when you also want to save the scanned images to a folder other than the one specified in **Save in**.

You can specify the folder from the pop-up menu.

Do not start any application

Saves to the folder specified in **Save in**.

►►► Note

- To add an application or folder to the pop-up menu, select **Add...** from the pop-up menu, then click



(Plus) in the displayed dialog and specify the application or folder.

Instructions

Opens this guide.

Defaults

You can restore the settings in the displayed screen to the default settings.

Settings (Driver) Dialog

Click **Driver** on the  (Scanning from a Computer) tab to display the **Settings (Driver)** dialog.

In the **Settings (Driver)** dialog, you can specify how to save images when scanning items by starting the scanner driver from IJ Scan Utility and how to respond after saving them.

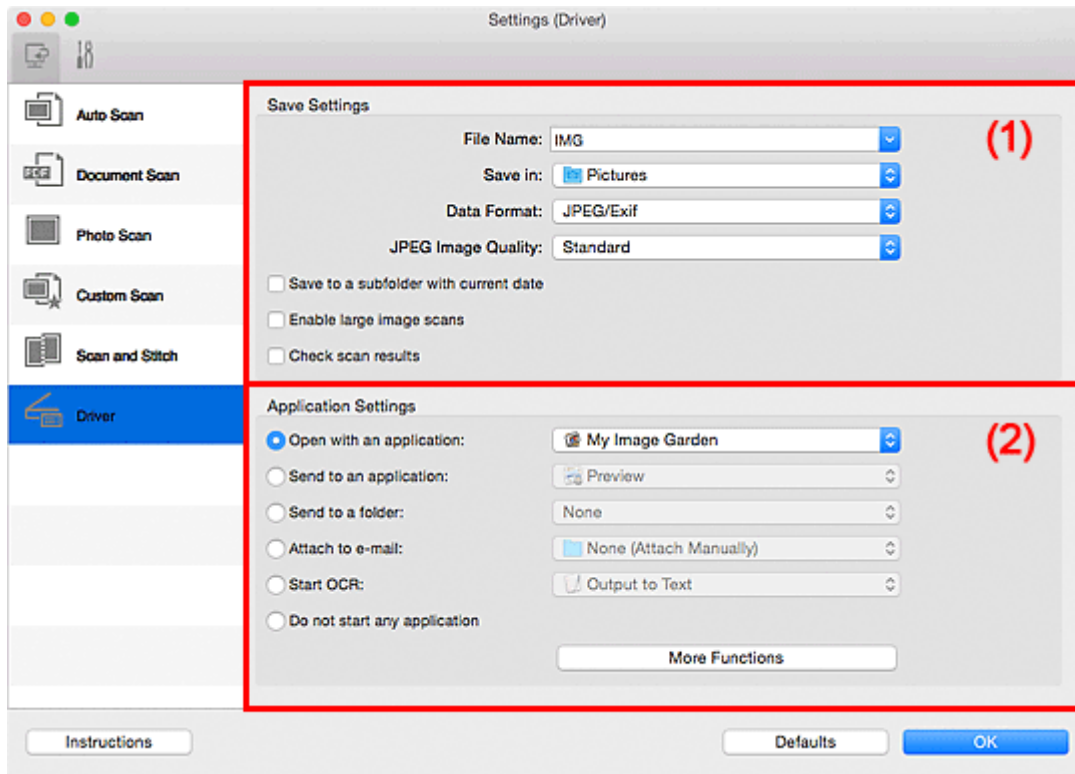

■ (1) [Save Settings Area](#)

■ (2) [Application Settings Area](#)

▶▶▶ Important

- When the Settings dialog is displayed from My Image Garden, the setting items for **Application Settings** do not appear.

(1) Save Settings Area

File Name

Enter the file name of the image to be saved. When you save a file, the date and four digits are appended to the set file name in the "_20XX0101_0001" format.

▶▶▶ Note

- When you select the **Save to a subfolder with current date** checkbox, the date and four digits are appended to the set file name.

Save in

Displays the folder in which to save the scanned images. To add a folder, select **Add...** from the pop-up menu, then click  (Plus) in the displayed dialog and specify the destination folder.

The default save folder is the **Pictures** folder.

»»» Important

- When the Settings dialog is displayed from My Image Garden, this option does not appear.

Data Format

Select the data format in which to save the scanned images.

You can select **JPEG/Exif**, **TIFF**, **PNG**, **PDF**, or **PDF (Multiple Pages)**.

»»» Note

- When **PDF** or **PDF (Multiple Pages)** is selected, images up to 9600 pixels x 9600 pixels can be scanned.
- When the **Enable large image scans** checkbox is selected in **Save Settings**, or when **Start OCR** is selected in **Application Settings**, you can select **JPEG/Exif**, **TIFF**, or **PNG**.

JPEG Image Quality

You can specify the image quality of JPEG files.

»»» Important

- This appears only when **JPEG/Exif** is selected in **Data Format**.

PDF Compression

Select the compression type for saving PDF files.

Standard

It is recommended that you normally select this setting.

High

Compresses the file size when saving, allowing you to reduce the load on your network/server.

»»» Important

- This appears only when **PDF** or **PDF (Multiple Pages)** is selected in **Data Format**.

Create a PDF file that supports keyword search

Select this checkbox to convert text in images into text data and create PDF files that support keyword search.

»»» Important

- This appears only when **PDF** or **PDF (Multiple Pages)** is selected in **Data Format**.

»»» Note

- PDF files that are searchable in the language selected in **Document Language** on the  (General Settings) tab of the Settings dialog are created.

Save to a subfolder with current date

Select this checkbox to create a current date folder in the folder specified in **Save in** and save scanned images in it. The folder will be created with a name such as "20XX_01_01" (Year_Month_Date).

If this checkbox is not selected, files are saved directly in the folder specified in **Save in**.

Enable large image scans

Select this checkbox to scan images up to 21000 pixels x 30000 pixels and 1.8 GB.

▶▶▶ Important

- When this checkbox is selected, you cannot select **Send to an application**, **Send to a folder**, **Attach to e-mail**, or **Start OCR**.
- When the Settings dialog is displayed from My Image Garden, this option does not appear.

▶▶▶ Note

- When this checkbox is not selected, images up to 10208 pixels x 14032 pixels can be scanned.

Check scan results

Displays the [Save Settings dialog](#) after scanning.

▶▶▶ Important

- When the Settings dialog is displayed from My Image Garden, this option does not appear.

(2) Application Settings Area

Open with an application

Select this when you want to enhance or correct the scanned images.

You can specify the application from the pop-up menu.

Send to an application

Select this when you want to use the scanned images as they are in an application that allows you to browse or organize images.

You can specify the application from the pop-up menu.

Send to a folder

Select this when you also want to save the scanned images to a folder other than the one specified in **Save in**.

You can specify the folder from the pop-up menu.

Attach to e-mail

Select this when you want to send e-mails with the scanned images attached.

You can specify the e-mail client you want to start from the pop-up menu.

Start OCR

Select this when you want to convert text in the scanned image into text data.

You can specify the application from the pop-up menu.

Do not start any application

Saves to the folder specified in **Save in**.

▶▶▶ Note

- To add an application or folder to the pop-up menu, select **Add...** from the pop-up menu, then click  (Plus) in the displayed dialog and specify the application or folder.

Instructions

Opens this guide.

Defaults

You can restore the settings in the displayed screen to the default settings.

Settings (General Settings) Dialog

Click the  (General Settings) tab to display the **Settings (General Settings)** dialog.

In the **Settings (General Settings)** dialog, you can set the product to use, file size restriction on e-mail attachment, language to detect text in images, and folder in which to save images temporarily.

»» Important

- When the Settings dialog is displayed from My Image Garden, some options may not appear.

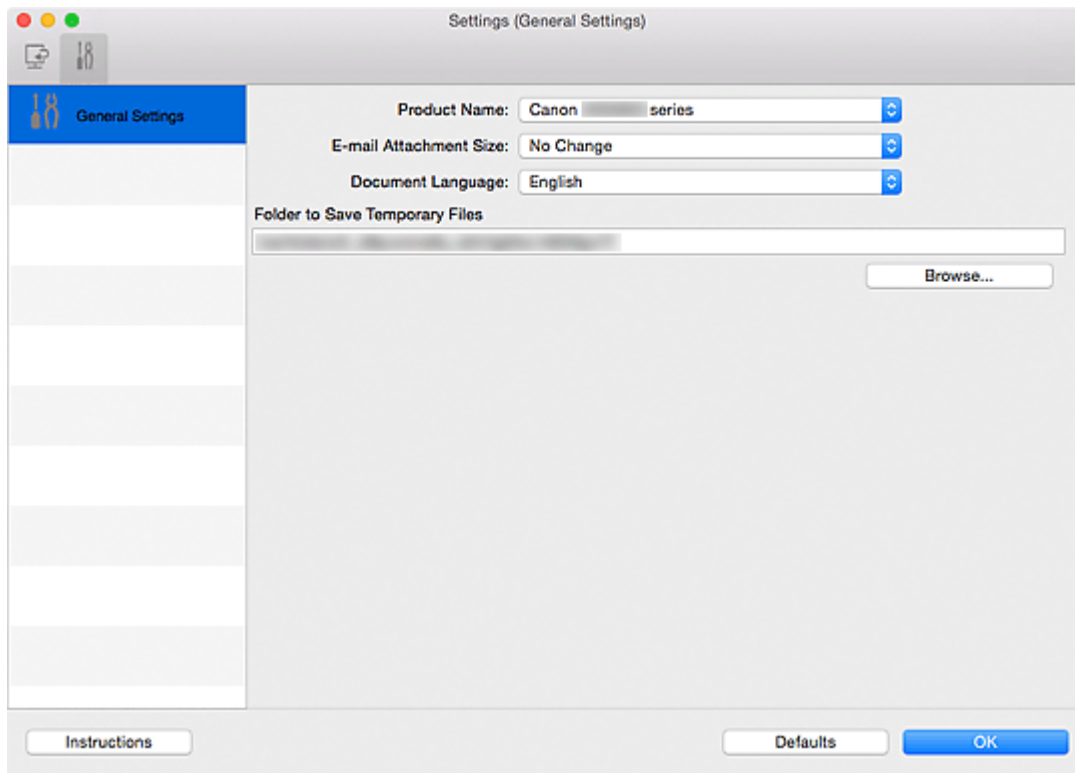

Product Name

Displays the name of the product that IJ Scan Utility is currently set to use.

If the displayed product is not the one you want to use, select the desired product from the list.

E-mail Attachment Size

You can restrict the size of scanned images to be attached to an e-mail.

You can select **Small (Suitable for 640 x 480 Windows)**, **Medium (Suitable for 800 x 600 Windows)**, **Large (Suitable for 1024 x 768 Windows)**, or **No Change**.

Document Language

You can select the language for detecting text in images and for use with search when a PDF file that supports keyword search is created.

Folder to Save Temporary Files

Displays the folder in which to save images temporarily. Click **Browse...** to specify the destination folder.

Instructions

Opens this guide.

Defaults

You can restore the settings in the displayed screen to the default settings.

Save Settings Dialog

Select the **Check scan results** checkbox in **Save Settings** of the Settings dialog to display the **Save Settings** dialog after scanning.

You can specify the data format and destination while viewing the thumbnails of scan results.

»» Important

- After scanning from My Image Garden, the **Save Settings** dialog does not appear.

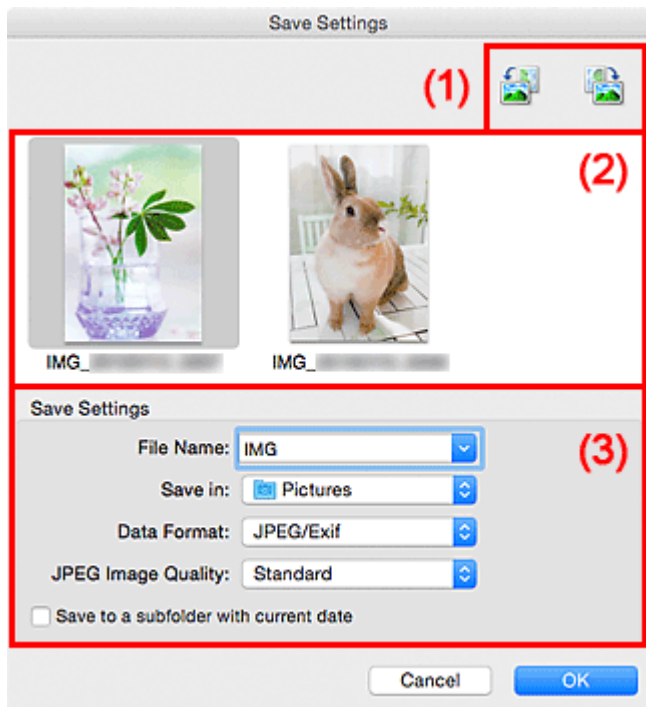

■ (1) [Preview Operation Buttons](#)

■ (2) [Scan Results Area](#)

■ (3) [Save Settings Area](#)

(1) Preview Operation Buttons

 /  (Rotate Left 90°)/(Rotate Right 90°)

Rotates scanned images 90 degrees counter-clockwise or clockwise.

Select the image you want to rotate, then click  (Rotate Left 90°) or  (Rotate Right 90°).

»» Important

- The preview operation buttons do not appear when the **Enable large image scans** checkbox is selected in the **Settings (Driver)** dialog.

(2) Scan Results Area

Displays the thumbnails of the scanned images. You can change the save order of images via drag-and-drop. The file names for saving appear below the thumbnails.

(3) Save Settings Area

File Name

Enter the file name of the image to be saved. When you save a file, the date and four digits are appended to the set file name in the "_20XX0101_0001" format.

▶▶▶ Note

- When you select the **Save to a subfolder with current date** checkbox, the date and four digits are appended to the set file name.

Save in

Displays the folder in which to save the scanned images. To add a folder, select **Add...** from the pop-up menu, then click (Plus) in the displayed dialog and specify the destination folder.

The default save folder is the **Pictures** folder.

Data Format

Select the data format in which to save the scanned images.

You can select **JPEG/Exif**, **TIFF**, **PNG**, **PDF**, or **PDF (Multiple Pages)**.

▶▶▶ Important

- You cannot select **PDF** or **PDF (Multiple Pages)** in the following cases.
 - When scanned by clicking **Photo** in the IJ Scan Utility main screen
 - The **Enable large image scans** checkbox is selected in **Save Settings** of the **Settings (Driver)** dialog
 - **Start OCR** is selected in **Application Settings** of the **Settings (Document Scan)**, **Settings (Custom Scan)**, or **Settings (Driver)** dialog
- You cannot select **JPEG/Exif** when **Color Mode** is **Black and White**.

JPEG Image Quality

You can specify the image quality of JPEG files.

▶▶▶ Important

- This appears only when **JPEG/Exif** is selected in **Data Format**.

PDF Compression

Select the compression type for saving PDF files.

Standard

It is recommended that you normally select this setting.

High

Compresses the file size when saving, allowing you to reduce the load on your network/server.

▶▶▶ Important

- This appears only when **PDF** or **PDF (Multiple Pages)** is selected in **Data Format**.
- When **Black and White** is selected in **Color Mode**, this option does not appear.

Create a PDF file that supports keyword search

Select this checkbox to convert text in images into text data and create PDF files that support keyword search.

»» Important

- This appears only when **PDF** or **PDF (Multiple Pages)** is selected in **Data Format**.

»» Note

- PDF files that are searchable in the language selected in **Document Language** on the  (General Settings) tab of the Settings dialog are created.

Save to a subfolder with current date

Select this checkbox to create a current date folder in the folder specified in **Save in** and save scanned images in it. The folder will be created with a name such as "20XX_01_01" (Year_Month_Date).

If this checkbox is not selected, files are saved directly in the folder specified in **Save in**.

Image Stitch Window

Click **Stitch** in the IJ Scan Utility main screen to display the **Image Stitch** window.

You can scan the left and right halves of an item larger than the platen and combine them back into one image. You can scan items up to approximately twice as large as the platen.

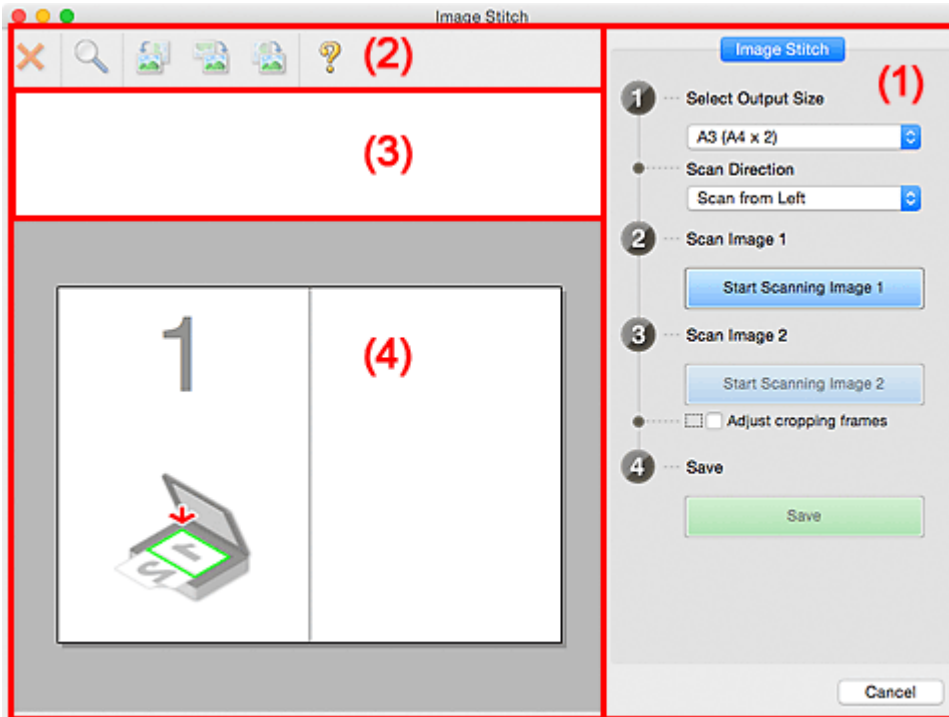

- [\(1\) Settings and Operation Buttons](#)
- [\(2\) Toolbar](#)
- [\(3\) Thumbnail View Area](#)
- [\(4\) Preview Area](#)

▶▶▶ Note

- The displayed items vary depending on the select source and view.

(1) Settings and Operation Buttons

Select Output Size

B4 (B5 x 2)

Scans the left and right halves of a B4 size item separately.

A3 (A4 x 2)

Scans the left and right halves of an A3 size item separately.

11 x 17 (Letter x 2)

Scans the left and right halves of an item twice as large as Letter size separately.

Full Platen x 2

Scans the left and right halves of an item twice as large as the platen separately.

Scan Direction

Scan from Left

Displays the first scanned image on the left side.

Scan from Right

Displays the first scanned image on the right side.

Scan Image 1

Start Scanning Image 1

Scans the first item.

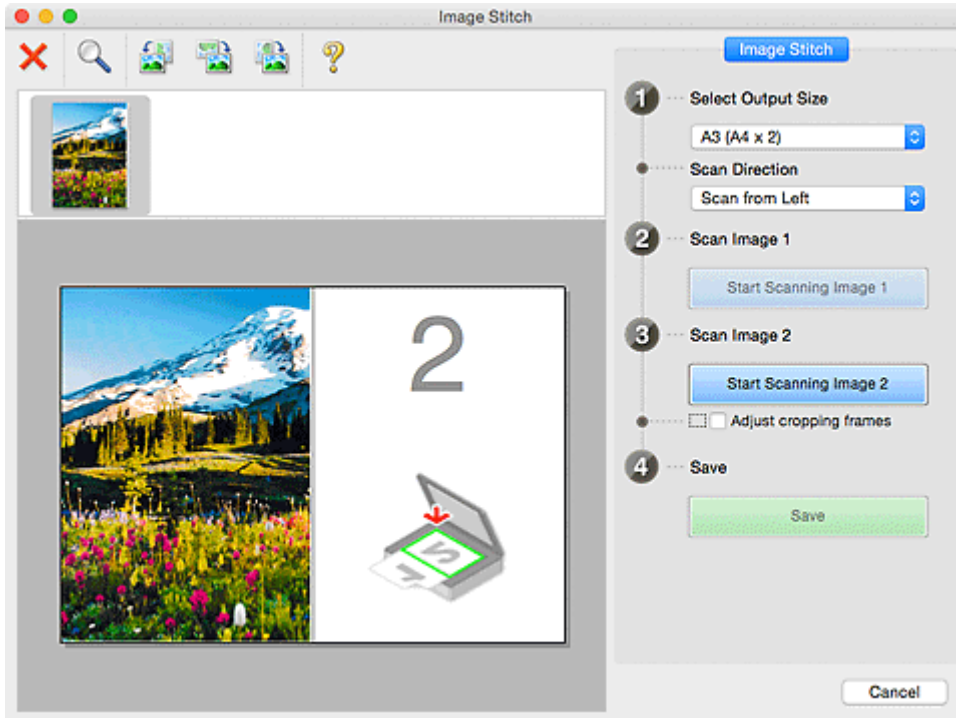

Scan Image 2

Start Scanning Image 2

Scans the second item.

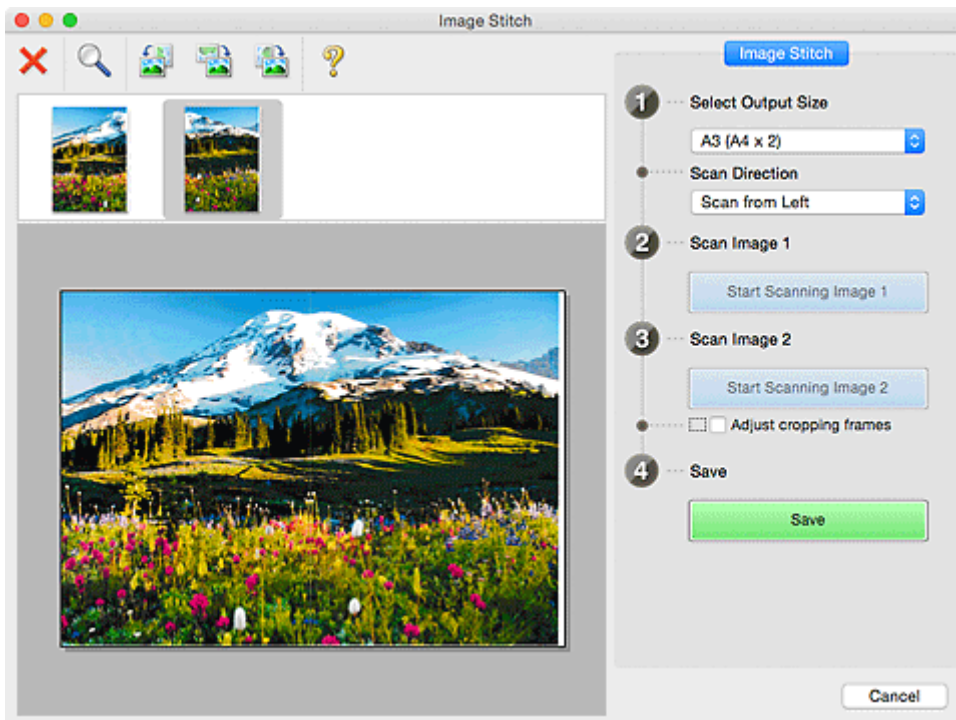

Adjust cropping frames

You can adjust the scan area in preview.

If no area is specified, the image of the size selected in **Select Output Size** will be saved. If an area is specified, only the image in the cropping frame will be scanned and saved.

■ [Adjusting Cropping Frames in the Image Stitch Window](#)

Save

Save

Saves the two scanned images as one image.

Cancel

Cancels **Stitch** scan.

(2) Toolbar

You can delete the scanned images or adjust the previewed images.



(Delete)

Deletes the image selected in the Thumbnail View area.



(Enlarge/Reduce)

Allows you to enlarge or reduce the preview image.

Left-clicking the Preview area enlarges the displayed image.

Control-clicking the Preview area reduces the displayed image.



(Rotate Left)

Rotates the preview image 90 degrees counter-clockwise.



(Rotate 180°)

Rotates the preview image 180 degrees.



(Rotate Right)

Rotates the preview image 90 degrees clockwise.



(Open Guide)

Opens this page.

(3) Thumbnail View Area

Displays the thumbnails of the scanned images. Appears blank if none has been scanned.

(4) Preview Area

Displays the scanned images. You can adjust the layout by dragging the scanned image or check the results of the settings made in "[\(1\) Settings and Operation Buttons.](#)"

When no image has been scanned:

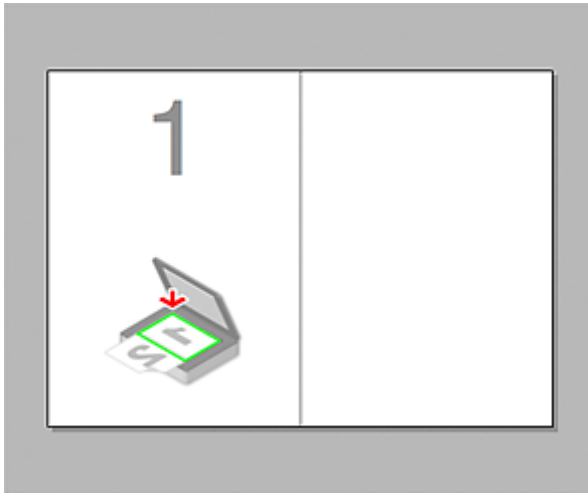

After scanning the first item by clicking Start Scanning Image 1:

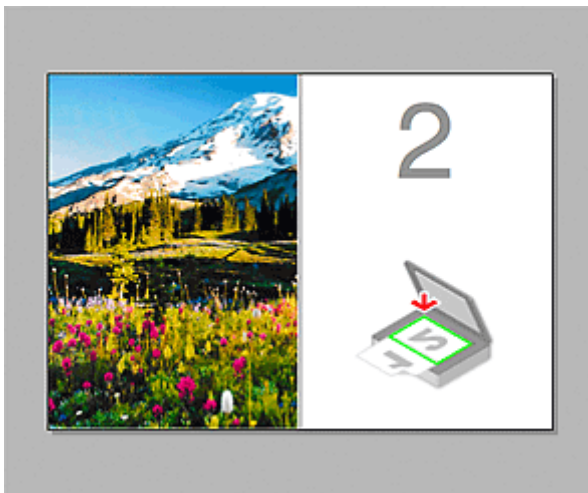

The image is scanned in the direction specified in **Scan Direction**, and **2** appears next to it.

After scanning the second item by clicking Start Scanning Image 2:



The two scanned images appear.

Related Topic

- [Scanning Originals Larger than the Platen \(Image Stitch\)](#)

Using Scanner Driver

You can scan by starting the scanner driver from various applications.

Refer to Help of Mac OS for how to scan.

▶▶▶ Note

- Refer to "[Image Corrections and Color Adjustments](#)" for details on the setting procedures for image correction and color adjustment.
- Refer to "[General Notes \(Scanner Driver\)](#)" for the scanner driver.
- Refer to "[Updating the Scanner Driver](#)" for the scanner driver.
- In the [Settings \(Driver\) dialog](#) of IJ Scan Utility, you can also make advanced settings for scanning with the scanner driver.

Image Corrections and Color Adjustments

You can correct images and adjust colors using the scanner driver.

▶▶▶ Important

- When image correction or color adjustment is applied to items without moire, dust/scratches, or faded colors, the color tone may be adversely affected.
- Image correction results are not reflected in the trial scan screen.

▶▶▶ Note

- Screens may vary depending on the application.
- Selectable settings depend on **Kind** settings.
- Scanning may take longer than usual when image correction or color adjustment is applied.

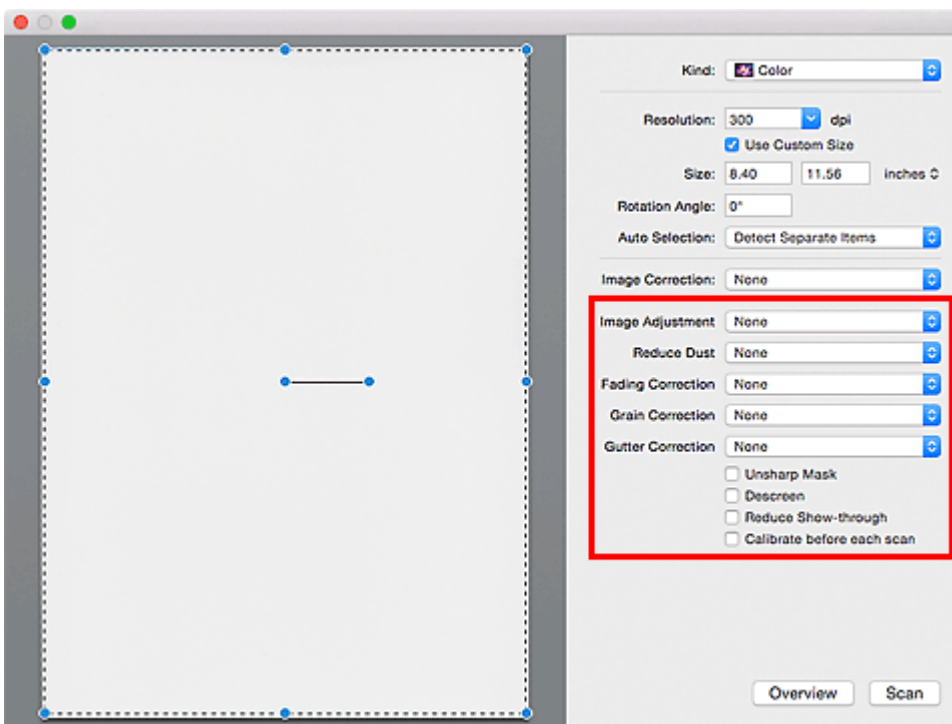

Image Adjustment

When Image Adjustment is set, the brightness of the specified portion of the image is optimized. Images can be adjusted according to the automatically detected item type or the specified item type. The result of the adjustment will be reflected in the entire image.

None

Image Adjustment will not be applied.

Auto

Applies Image Adjustment by automatically detecting the item type. It is recommended that you normally select this setting.

Photo

Applies Image Adjustment suitable for photos.

Magazine

Applies Image Adjustment suitable for magazines.

Document

Applies Image Adjustment suitable for text documents.

»» Note

- If the image is not adjusted properly with **Auto**, specify the item type.
- The color tone may change from the source image due to the Image Adjustment. In that case, set **Image Adjustment** to **None**.

Reduce Dust

Scanned photos may contain white dots caused by dust or scratches. Use this function to reduce such noise.

None

Dust and scratches will not be reduced.

Low

Select this to reduce small dust particles and scratches. Large ones may remain.

Medium

It is recommended that you normally select this setting.

High

Select this to reduce large dust particles and scratches; however, evidence of the reduction process may remain or delicate parts of the image may be removed.

»» Important

- This function may not be effective for some types of photos.

»» Note

- It is recommended that you select **None** when scanning printed materials.

Fading Correction

Use this function to correct photos that have faded with time or have a colorcast. "Colorcast" is a phenomenon where a specific color affects the entire picture due to the weather or ambient strong colors.

None

Fading Correction will not be applied.

Low

Select this to correct a small amount of fading and colorcast.

Medium

It is recommended that you normally select this setting.

High

Select this to correct a large amount of fading and colorcast. This can affect the tone of the image.

»» Important

- Correction may not be applied properly if the scan area is too small.
- Not effective if **Color** is not selected for **Kind**.

Grain Correction

Use this function to reduce graininess (roughness) in photos taken with high-speed or sensitized film, etc.

None

Graininess will not be reduced.

Low

Select this when the photo is slightly grainy.

Medium

It is recommended that you normally select this setting.

High

Select this when the photo is very grainy. This can affect the gradation and sharpness of the image.

►► Important

- Correction may not be applied properly if the scan area is too small.

Gutter Correction

Use this function to correct shadows that appear between pages when scanning open booklets.

Unclear or blurred text/lines caused by curved pages are not corrected.

None

Gutter shadow will not be corrected.

Low

Select this when the effect level is too strong with the medium setting.

Medium

It is recommended that you normally select this setting.

High

Select this when the effect level is too weak with the medium setting.

►► Important

- Do not place objects that weigh 4.4 lbs (2.0 kg) or more on the platen. In addition, do not press on the item with a force exceeding 4.4 lbs (2.0 kg). If you press heavily, the scanner may not work correctly or you might break the glass.
- Align the item with the edge of the platen. If placed slanted, correction will not be applied properly.



- Correction may not be applied properly depending on the item. If the page background is not white, shadows may not be detected correctly or may not be detected at all.
- While scanning, press down on the spine with the same amount of pressure you used to preview the scan. If the binding part is not even, correction will not be applied properly.

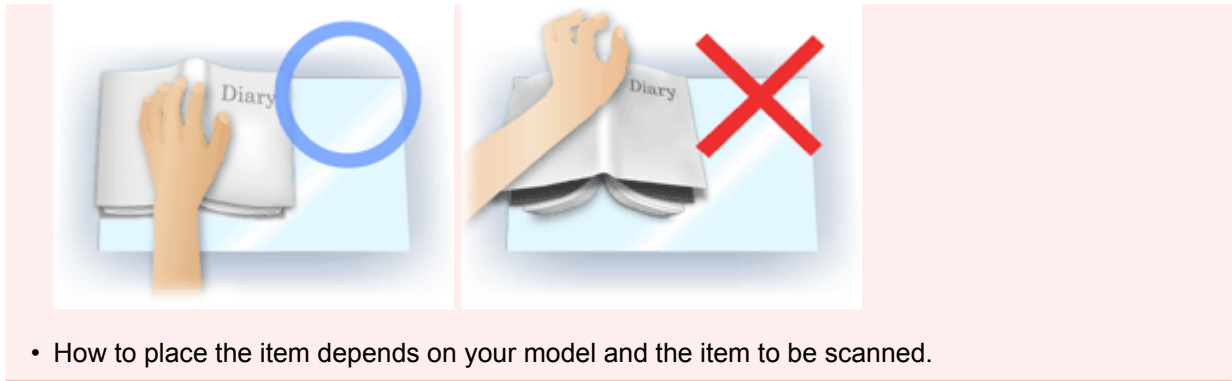

- How to place the item depends on your model and the item to be scanned.

Unsharp Mask

Emphasizes the outline of the subjects to sharpen the image.

Descreen

Reduces moire patterns.

Printed materials are displayed as a collection of fine dots. "Moire" is a phenomenon where uneven gradation or a stripe pattern appears when such photos or pictures printed with fine dots are scanned.

►►► Important

- When enabling **Descreen**, disable **Unsharp Mask**. If **Unsharp Mask** is enabled, some moire effects may remain.

►►► Note

- Scanning takes longer than usual when you enable **Descreen**.

Reduce Show-through

Use this function to reduce show-through in duplex documents or lighten the base color in recycled paper and other colored paper when scanning documents.

►►► Important

- **Reduce Show-through** is effective only when **Document** or **Magazine** is selected for **Image Adjustment**.

Calibrate before each scan

Calibrates the scanner every time before trial scanning and scanning, to reproduce correct color tones in scanned images.

►►► Note

- Calibration may take time depending on your computer.

General Notes (Scanner Driver)

The scanner driver is subject to the following restrictions. Keep these points in mind when using the scanner driver.

Scanner Driver Restrictions

- If the computer is shared among multiple users or when you have logged out and back on, a message indicating that the scanner driver is in use may appear. In that case, disconnect the USB cable from the computer, then reconnect it.
- Scanning may fail if the computer has resumed from sleep state with the scanner driver active. In that case, follow these steps and scan again.
 1. Turn off the machine.
 2. Exit the scanner driver, then disconnect the USB cable from the computer and reconnect it.
 3. Turn on the machine.
- Do not connect two or more scanners or multifunction printers with scanner function to the same computer simultaneously. If multiple scanning devices are connected, you may experience errors while accessing the devices.
- When using a network compatible model by connecting to a network, the machine cannot be accessed from multiple computers at the same time.
- When using a network compatible model by connecting to a network, scanning takes longer than usual.
- Make sure that you have adequate disk space available when scanning large images at high resolutions. For example, at least 300 MB of free space is required to scan an A4 document at 600 dpi in full-color.
- Do not enter the computer into sleep or hibernate state during scanning.

Updating the Scanner Driver

- **Obtaining the Latest Scanner Driver**
- **Before Installing the Scanner Driver**
- **Installing the Scanner Driver**

Obtaining the Latest Scanner Driver

Upgrading your current scanner driver to the latest scanner driver may solve some problems you have experienced.

To obtain the scanner driver, access our website and download the scanner driver for your model.

Important

- Scanner driver can be downloaded for free; however, Internet connection fees apply.

Related Topic

- [Before Installing the Scanner Driver](#)
- [Installing the Scanner Driver](#)

Before Installing the Scanner Driver

Check the following points before installing the scanner driver. Check these also when you cannot install the scanner driver.

Machine Status

- If the machine and computer are connected with a USB cable, disconnect the USB cable from the computer.

Computer Settings

- Close all running applications.
- Log in as the administrator of the computer. You will be required to enter the name and password of the user with administrator privileges. If you have multiple user accounts on Mac OS X, log in with the first administrator account created.

»» Important

- If you install an older version of the scanner driver after installing a newer one, the scanner driver may not operate properly. In that case, reinstall the newer scanner driver.

»» Note

- When installing multiple versions of the scanner driver, install the older scanner driver first.

Related Topic

- [Obtaining the Latest Scanner Driver](#)
- [Installing the Scanner Driver](#)

Installing the Scanner Driver

Access our website via the Internet to download the latest scanner driver.

Follow these steps to install the downloaded scanner driver.

1. Mount the disk.

Double-click the downloaded disk image file.

The file is decompressed and the disk is mounted.

2. Start the installer.

Double-click the ".pkg" file in the decompressed disk.

Installation starts.

3. Install the driver.

Follow the prompts to install.

When the license agreement screen appears, read the terms and click **Continue**. If you do not accept the license agreement, you cannot install this software.

If an authentication screen appears, enter the administrator's name and password, then click **Install Software**.

4. Complete the installation.

The scanner driver is installed.

Important

- Installation may fail if you click **Go Back** during the process. In that case, select **Quit Installer** from the **Installer** menu to exit the installer, then start over the installation.
- Scanner driver can be downloaded for free; however, Internet connection fees apply.

Related Topic

- [Obtaining the Latest Scanner Driver](#)
- [Before Installing the Scanner Driver](#)

Scanning Tips

- ▶ **Resolution**
- ▶ **Data Formats**

Resolution

The data in the image you have scanned is a collection of dots carrying information about brightness and color. The density of these dots is called "resolution," and resolution will determine the amount of detail your image contains. The unit of resolution is dots per inch (dpi). Dpi is the number of dots per inch (2.5 cm).

The higher the resolution (value), the more detail in your image; the lower the resolution (value), the less detail.

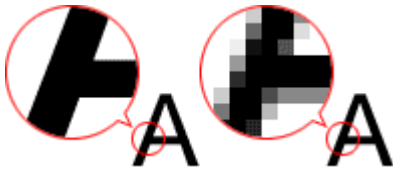

How to Set the Resolution

You can set the resolution in **Resolution** on the  (Scanning from a Computer) tab of the Settings dialog.

Appropriate Resolution Settings

Set the resolution according to the use of the scanned image.

Item Type	Use	Color Mode	Appropriate Resolution
Color photo	Copying (Printing)	Color	300 dpi
	Creating a postcard	Color	300 dpi
	Saving to a computer	Color	300 dpi
	Using on a website or attaching to e-mail	Color	150 dpi
Black and white photo	Saving to a computer	Grayscale	300 dpi
	Using on a website or attaching to e-mail	Grayscale	150 dpi
Text document (document or magazine)	Copying	Color, Grayscale, or Black and White	300 dpi
	Attaching to e-mail	Color, Grayscale, or Black and White	150 dpi
	Scanning text using OCR	Color or Grayscale	300 dpi

»» Important

- If you double the resolution, the data size of the scanned image quadruples. If the file is too large, the processing speed will slow down significantly, and you will experience inconvenience such as lack of memory. Set the minimum required resolution according to the use of the image.

➤➤ Note

- When you will be printing the scanned image by enlarging it, scan by setting a higher resolution than the recommended one above.

Data Formats

You can select a data format when saving scanned images. You should specify the most suitable data format according to how you want to use the image on which application.

Available data formats vary by application and operating system (Windows or Mac OS).

See below for the characteristics of each image data format.

PNG (Standard File Extension: .png)

A data format often used on websites.

PNG is suitable for editing saved images.

JPEG (Standard File Extension: .jpg)

A data format often used on websites and for digital camera images.

JPEG features high compression rates. JPEG images slightly degrade every time they are saved, and cannot be returned to their original state.

JPEG is not available for black and white images.

TIFF (Standard File Extension: .tif)

A data format featuring a relatively high compatibility between various computers and applications.

TIFF is suitable for editing saved images.

»» Note

- Some TIFF files are incompatible.
- IJ Scan Utility supports the following TIFF file formats.
 - Uncompressed, black and white binary
 - Uncompressed, RGB (8 bits per channel)
 - Uncompressed, Grayscale

PDF (Standard File Extension: .pdf)

A data format for electronic documents, developed by Adobe Systems Incorporated.

It can be used on various computers and operating systems, and fonts can be embedded as well; therefore, people in different environments can exchange the files without being aware of the differences.

Positioning Originals (Scanning from Computer)

Learn how to place items on the platen of your scanner or printer. Place items correctly according to the type of item to be scanned. Otherwise, items may not be scanned correctly.

▶▶▶ Important

- Do not place objects on the document cover. When you open the document cover, the objects may fall into your scanner or printer, resulting in malfunction.
- Close the document cover when scanning.

Placing Items

Place items as described below to scan by detecting the item type or size automatically.

▶▶▶ Important

- When scanning by specifying the paper size in IJ Scan Utility or the scanner driver, align an upper corner of the item with the corner at the arrow (alignment mark) of the platen.
- Photos that have been cut to various shapes and items smaller than 1.2 inches (3 cm) square cannot be cropped accurately when scanning.
- Reflective disc labels may not be scanned as expected.
- When scanned using the scanner driver, the response may differ. In that case, adjust the cropping frame (selection box) manually.

For Photos, Postcards, Business Cards, or BD/DVD/CD	For Magazines, Newspapers, or Documents
<div data-bbox="220 1137 724 1258" data-label="Image"> </div> <p data-bbox="188 1317 440 1346">Placing a Single Item:</p> <p data-bbox="188 1361 815 1496">Place the item face-down on the platen, with 0.4 inch (1 cm) or more space between the edges (diagonally striped area) of the platen and the item. Portions placed on the diagonally striped area cannot be scanned.</p> <div data-bbox="188 1514 695 1877" data-label="Diagram"> </div> <p data-bbox="188 1906 400 1944">▶▶▶ Important</p> <ul data-bbox="212 1957 815 2018" style="list-style-type: none"> • Large items (such as A4 size photos) that cannot be placed away from the edges/arrow (alignment mark) of 	<div data-bbox="922 1137 1305 1258" data-label="Image"> </div> <p data-bbox="839 1301 1417 1435">Place the item face-down on the platen and align an upper corner of the item with the corner at the arrow (alignment mark) of the platen. Portions placed on the diagonally striped area cannot be scanned.</p> <div data-bbox="839 1451 1347 1818" data-label="Diagram"> </div> <p data-bbox="839 1848 1050 1886">▶▶▶ Important</p> <ul data-bbox="863 1899 1417 2002" style="list-style-type: none"> • Refer to "Loading Originals" for your model from Home of the <i>Online Manual</i> for details on the portions in which items cannot be scanned.

the platen may be saved as PDF files. To save in a format other than PDF, scan by specifying the data format.

Placing Multiple Items:

Allow 0.4 inch (1 cm) or more space between the edges (diagonally striped area) of the platen and items, and between items. Portions placed on the diagonally striped area cannot be scanned.

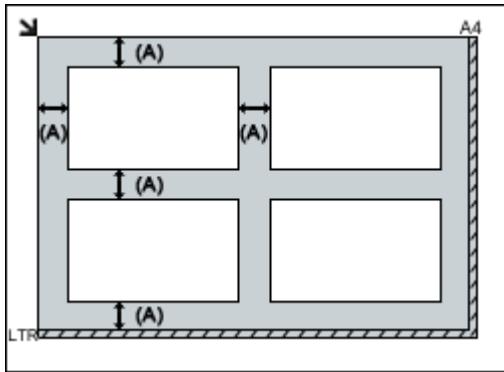

(A) more than 0.4 inch (1 cm)

▶▶▶ Note

- In IJ Scan Utility, you can place up to 12 items.
- Positions of slanted items (10 degrees or less) are corrected automatically.

Troubleshooting

Frequently Asked Questions

- [Printing Does Not Start](#)
- [Paper Is Blank/Printing Is Blurry/Colors Are Wrong/White Streaks Appear](#)
- [An Error Occurs](#)
- [Print Results Are Unsatisfactory](#)
- [Message Appears](#)
- [Cannot Install MP Drivers](#)
- [Paper Jams](#)

Examples of Problems

- Machine Does Not Move
 - [Power Does Not Come On](#)
 - [Power Shuts Off By Itself](#)
 - [Printing Does Not Start](#)
 - [Paper Jams](#)
 - Scanning Problems (Windows)
 - [Scanning Problems](#) (Mac OS)
- Cannot Set Correctly
 - [Cannot Connect to Computer Properly](#)
 - [Cannot Install MP Drivers](#)
 - [Easy-WebPrint EX Does Not Start or Easy-WebPrint EX Menu Does Not Appear \(Windows\)](#)
- Print/Scan Results Are Unsatisfactory
 - [Printing Does Not Start](#)
 - [Copying/Printing Stops](#)
 - [Print Results Are Unsatisfactory](#)
 - [No Ink Comes Out](#)
 - [Paper Jams](#)
 - [Paper Does Not Feed Properly/"No Paper" Error](#)
 - Scan Results Are Unsatisfactory (Windows)
 - [Scan Results Are Unsatisfactory](#) (Mac OS)
- Error or Message Appears
 - [An Error Occurs](#)
 - [Message Appears](#)
 - [List of Support Code for Error](#)
 - IJ Scan Utility Error Messages (Windows)
 - [IJ Scan Utility Error Messages](#) (Mac OS)
 - ScanGear (Scanner Driver) Error Messages
 - [Scanner Driver Error Messages](#)

Operation Problems

- [Printing Problems](#)
- Scanning Problems (Windows)
- [Scanning Problems \(Mac OS\)](#)
- [Mechanical Problems](#)
- [Installation and Download Problems](#)
- [Errors and Messages](#)
- [If You Cannot Solve a Problem](#)
- [Repairing Your Machine](#)

Printing Problems

- **Printing Does Not Start**
- **Paper Jams**
- **Print Results Are Unsatisfactory**
- **No Ink Comes Out**
- **Paper Does Not Feed Properly/"No Paper" Error**
- **Copying/Printing Stops**



Printing Does Not Start



Check1 Make sure machine is securely plugged in and press **ON** button to turn it on.

The **ON** lamp flashes while the machine is initializing. Wait until the **ON** lamp stops flashing and remains lit.

▶▶▶ Note

- If you are printing large data such as photos or other graphics, printing may take longer to start. The **ON** lamp flashes while the computer is processing data and sending it to the machine. Wait until printing starts.

Check2 Make sure machine is properly connected to computer.

When the machine is connected to your computer with a USB cable, check the following:

- If you are using a relay device such as a USB hub, disconnect it, connect the machine directly to the computer, and retry the printing. If printing starts normally, there is a problem with the relay device. Contact the vendor of the relay device.
- There could also be a problem with the USB cable. Replace the USB cable and retry the printing.

Check3 If printing from a computer, delete unnecessary print jobs.

- For Windows:
 - [Deleting the Undesired Print Job](#)
- For Mac OS:
 - [Deleting the Undesired Print Job](#)

Check4 Is your machine's printer driver is selected when printing?

The machine will not print properly if you are using a printer driver for a different printer.

- For Windows:

Make sure "Canon XXX series Printer" (where "XXX" is your machine's name) is selected in the Print dialog box.

▶▶▶ Note

- To make the machine the one selected by default, select **Set as Default Printer**.

- For Mac OS:

Make sure your machine's name is selected in **Printer** in the Print dialog.

▶▶▶ Note

- To make the machine the one selected by default, select the machine for **Default printer**.

Check5 Set correct printer port. (Windows)

Make sure the correct printer port is set.

1. Log in using an account with administrator privileges.
2. Make the following settings.
 - In Windows 10, right-click **Start** button and select **Control Panel > View devices and printers**.
 - In Windows 8.1 or Windows 8, select **Control Panel** from **Settings** charm on **Desktop > Hardware and Sound > Devices and Printers**.
 - In Windows 7, select **Devices and Printers** from **Start** menu.
 - In Windows Vista, select **Start** menu > **Control Panel > Hardware and Sound > Printers**.
 - In Windows XP, select **Start** menu > **Control Panel > Printers and Other Hardware > Printers and Faxes**.
3. Open printer driver properties.
 - In Windows 10, Windows 8.1, Windows 8, or Windows 7, right-click "Canon XXX series Printer" icon (where "XXX" is your machine's name), and then select **Printer properties**.
 - In Windows Vista or Windows XP, right-click "Canon XXX series Printer" icon (where "XXX" is your machine's name), and then select **Properties**.
4. Click **Ports** tab to check port settings.

Make sure a port named "USBnnn" (where "n" is a number) with "Canon XXX series Printer" appearing in **Printer** column is selected for **Print to the following port(s)**.

- If setting is incorrect:

Reinstall the MP Drivers from the Setup CD-ROM or the Canon website.

- If printing does not start even though the machine is connected to the computer using a USB cable and the port named "USBnnn" is selected:

In Windows 10, click **Start** button and select **All apps, Canon Utilities, Canon My Printer, Canon My Printer**, and then select **Diagnose and Repair Printer**. Follow the on-screen instructions to set the correct printer port, and then select your machine's name.

In Windows 8.1 or Windows 8, select **My Printer** on **Start** screen to start **My Printer**. If **My Printer** is not displayed on **Start** screen, select **Search** charm, and then search for "**My Printer**".

Set the correct printer port on **Diagnose and Repair Printer**. Follow the on-screen instructions to set the correct printer port, and then select your machine's name.

In Windows 7, Windows Vista, or Windows XP, click **Start** and select **All programs, Canon Utilities, Canon My Printer, Canon My Printer**, and then select **Diagnose and Repair Printer**. Follow the on-screen instructions to set the correct printer port, and then select your machine's name.

If the problem is not resolved, reinstall the MP Drivers from the Setup CD-ROM or the Canon website.

Check6 Is print data extremely large? (Windows)

Click **Print Options** on **Page Setup** sheet of the printer driver. Then set **Prevention of Print Data Loss** to **On** in the dialog that appears.

* This may reduce print quality.

Check7 If printing from your computer, restart computer.



Paper Jams



When paper is jammed, the **Alarm** lamp flashes and a troubleshooting message is displayed on the computer screen automatically. Take the appropriate action described in the message.

- For Windows:

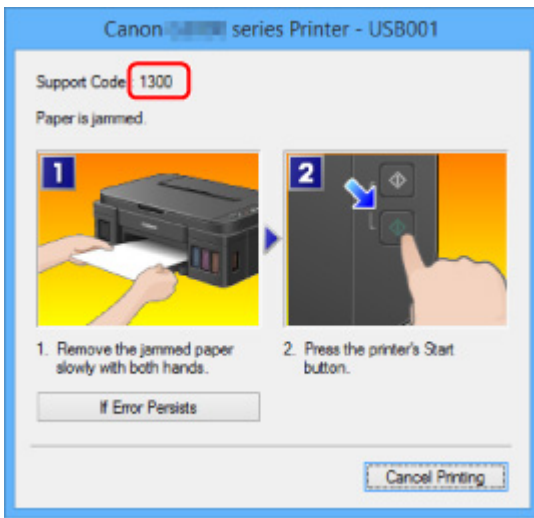

- For Mac OS:

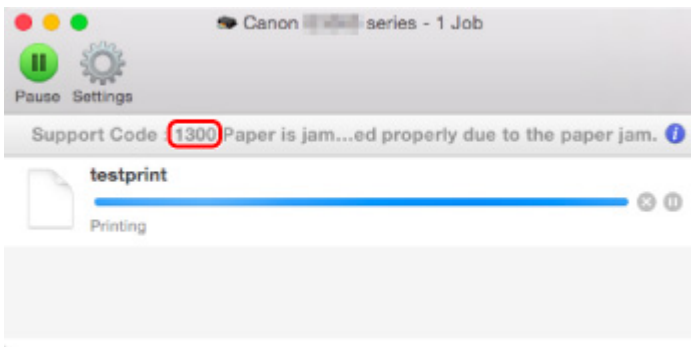

* The screen differs depending on the OS you are using.

To remove the jammed paper, see [List of Support Code for Error \(Paper Jams\)](#).

▶▶▶ Note

- You can also search for details on resolving the errors indicated by the support code shown.

■ [Search](#)



Print Results Are Unsatisfactory



If the print results are unsatisfactory due to white streaks, misaligned lines, or uneven colors, check the paper and print quality settings first.

Check1 Do page size and media type settings match size and type of loaded paper?

If these settings do not match, it is not possible to obtain the proper result.

If you are printing a photograph or an illustration, an incorrect paper type setting may reduce the quality of the printout color.

Also, if you print with an incorrect paper type setting, the printed surface may be scratched.

In borderless printing, uneven coloring may occur depending on the combination of the paper type setting and the loaded paper.

The method for checking the paper and print quality settings differs depending on what you are using your machine for.

Check the page size and media type settings using the printer driver.

- For Windows:

■ [Printing with Easy Setup](#)

- For Mac OS:

■ [Printing with Easy Setup](#)

Check2 Make sure appropriate print quality is selected using printer driver.

Select a print quality suited to the paper and to what you are printing. If you notice blurs or uneven colors, increase the print quality setting and retry the printing.

You can check the print quality setting using the printer driver.

- For Windows:

■ [Changing the Print Quality and Correcting Image Data](#)

- For Mac OS:

■ [Changing the Print Quality and Correcting Image Data](#)

Check3 If problem is not resolved, check other causes.

See also the sections below:

■ [Cannot Complete Printing](#)

■ [Paper Is Blank/Printing Is Blurry/Colors Are Wrong/White Streaks Appear](#)

■ [Colors Are Unclear](#)

■ [Lines Are Misaligned](#)

- ■ [Lines Incomplete or Missing \(Windows\)](#)
- ■ [Images Incomplete or Missing \(Windows\)](#)
- ■ [Ink Blots / Paper Curl](#)
- ■ [Paper Is Smudged / Printed Surface Is Scratched](#)
- ■ [Back of Paper Is Smudged](#)
- ■ [Vertical Line Next to Image](#)
- ■ [Uneven or Streaked Colors](#)



Cannot Complete Printing



Check1 Select setting not to compress printing data. (Windows)

If you select the setting not to compress the printing data with an application software you are using, the printing result may be improved.

Click **Print Options** on **Page Setup** sheet of the printer driver. Select **Do not allow application software to compress print data** check box and click **OK**.

* Clear the check box once printing is complete.

Check2 Is print data extremely large? (Windows)

Click **Print Options** on **Page Setup** sheet of the printer driver. Then set **Prevention of Print Data Loss** to **On** in the dialog that appears.

* This may reduce print quality.

Check3 Your hard disk may not have sufficient free space to store job.

Delete unnecessary files to free up disk space.



Paper Is Blank/Printing Is Blurry/Colors Are Wrong/White Streaks Appear

❖ Paper Is Blank



❖ Printing Is Blurry

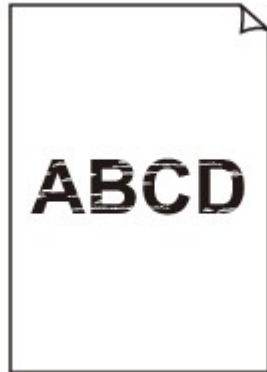

❖ Colors Are Wrong



White Streaks Appear

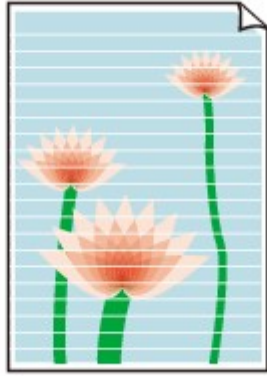

A



Check1 Check paper and print quality settings.

 [Print Results Are Unsatisfactory](#)

Check2 Print nozzle check pattern and perform any necessary maintenance operations such as print head cleaning.

Print the nozzle check pattern to determine whether the ink ejects properly from the print head nozzles.

For details on printing the nozzle check pattern, print head cleaning, and print head deep cleaning, see [If Printing Is Faint or Uneven](#).

- If nozzle check pattern is not printed correctly:
After performing the print head cleaning, print the nozzle check pattern and examine the pattern.
- If problem is not resolved after performing print head cleaning twice:
Perform print head deep cleaning.
- If problem is not resolved after performing print head deep cleaning:
Perform system cleaning.
 - From computer:
 - For Windows:
 [Cleaning the Print Heads](#)
 - For Mac OS:
 [Cleaning the Print Heads](#)
 - From operation panel:
To perform system cleaning, press and hold the **Stop** button until the **Alarm** lamp flashes 5 times, and then release the button.

Important

- Before performing system cleaning, check the remaining ink level of all colors. If the remaining ink level is below the single dot (a), refill the ink tank of corresponding color. Performing system cleaning when the remaining ink level is not enough may damage the machine.



If the problem is not resolved yet, the print head may be damaged. Contact your nearest Canon service center to request a repair.

►► Important

- Do not tilt the machine when moving it since the ink may leak out.
- When transporting the machine for repairing it, see [Repairing Your Machine](#).

Check3 When an ink tank runs out of ink, refill the ink tank.

If the remaining ink level is below the lower limit line (A), refill the ink tank with the corresponding color of ink.



After refilling the ink tank, perform system cleaning.

- From computer:
 - For Windows:
 - [Cleaning the Print Heads](#)
 - For Mac OS:
 - [Cleaning the Print Heads](#)

- From operation panel:

To perform system cleaning, press and hold the **Stop** button until the **Alarm** lamp flashes 5 times, and then release the button.

►► Important

- Before performing system cleaning, check the remaining ink level of all colors. If the remaining ink level is below the single dot (a), refill the ink tank of corresponding color. Performing system cleaning when the remaining ink level is not enough may damage the machine.



Check4 When using paper with one printable surface, make sure paper is loaded with printable side facing up.

Printing on the wrong side of such paper may cause unclear prints or prints with reduced quality.

Load paper with the printable side facing up.

Refer to the instruction manual supplied with the paper for detailed information on the printable side.

- **When copying, see also the sections below:**

Check5 Is platen glass dirty?

Clean the platen glass.

[Cleaning the Platen Glass and Document Cover](#)

Check6 Make sure original is properly loaded on platen glass.

[Loading Originals](#)

Check7 Is original loaded with side to be copied facing down on platen glass?

Check8 Did you copy a printout done by this machine?

If you use a printout done by this machine as the original, print quality may be reduced depending on the condition of the original.

Reprint from the computer if you can reprint from it.



Colors Are Unclear



Check1 Is nozzle check pattern printed properly?

Print the nozzle check pattern to determine whether the ink ejects properly from the print head nozzles.

For details on printing the nozzle check pattern, print head cleaning, and print head deep cleaning, see [If Printing Is Faint or Uneven](#).

- If nozzle check pattern is not printed correctly:

After performing the print head cleaning, print the nozzle check pattern and examine the pattern.

- If problem is not resolved after performing print head cleaning twice:

Perform print head deep cleaning.

- If problem is not resolved after performing print head deep cleaning:

Perform system cleaning.

- From computer:

- For Windows:

■ [Cleaning the Print Heads](#)

- For Mac OS:

■ [Cleaning the Print Heads](#)

- From operation panel:

To perform system cleaning, press and hold the **Stop** button until the **Alarm** lamp flashes 5 times, and then release the button.

Important

- Before performing system cleaning, check the remaining ink level of all colors. If the remaining ink level is below the single dot (a), refill the ink tank of corresponding color. Performing system cleaning when the remaining ink level is not enough may damage the machine.



If the problem is not resolved yet, the print head may be damaged. Contact your nearest Canon service center to request a repair.

Important

- Do not tilt the machine when moving it since the ink may leak out.

- When transporting the machine for repairing it, see [Repairing Your Machine](#).

Check2 When an ink tank runs out of ink, refill the ink tank.

If the remaining ink level is below the lower limit line (A), refill the ink tank with the corresponding color of ink.



After refilling the ink tank, perform system cleaning.

- From computer:
 - For Windows:
 - [Cleaning the Print Heads](#)
 - For Mac OS:
 - [Cleaning the Print Heads](#)

- From operation panel:

To perform system cleaning, press and hold the **Stop** button until the **Alarm** lamp flashes 5 times, and then release the button.

►► Important

- Before performing system cleaning, check the remaining ink level of all colors. If the remaining ink level is below the single dot (a), refill the ink tank of corresponding color. Performing system cleaning when the remaining ink level is not enough may damage the machine.



►► Note

- Printed colors may not match screen colors due to basic differences in the methods used to produce colors. Color control settings and environmental differences can also affect how colors appear on the screen. Therefore, colors of printing results may be different from those on the screen.



Lines Are Misaligned



Check1 Check paper and print quality settings.

■ [Print Results Are Unsatisfactory](#)

Check2 Perform print head alignment.

If printed lines are misaligned or print results are otherwise unsatisfactory, adjust the print head position.

■ [Aligning the Print Head](#)

▶▶▶ Note

- If the problem is not resolved after performing the print head alignment, perform print head alignment manually from your computer.
 - For Windows:
 - [Aligning the Print Head Position](#)
 - For Mac OS:
 - [Aligning the Print Head Position](#)

Check3 Increase print quality and try printing again.

Increasing the print quality using the printer driver may improve the print result.



Lines Incomplete or Missing (Windows)



Check1 Are you using Page Layout Printing or Binding Margin function?

When the Page Layout Printing or Binding margin function is in use, thin lines may not be printed. Try thickening the lines in the document.

Check2 Is print data extremely large?

Click **Print Options** on **Page Setup** sheet of the printer driver. Then set **Prevention of Print Data Loss** to **On** in the dialog that appears.

* This may reduce print quality.



Images Incomplete or Missing (Windows)



Check1 Select setting not to compress printing data.

If you select the setting not to compress the printing data with an application software you are using, the printing result may be improved.

Click **Print Options** on **Page Setup** sheet of the printer driver. Select **Do not allow application software to compress print data** check box and click **OK**.

* Clear the check box once printing is complete.

Check2 Is print data extremely large?

Click **Print Options** on **Page Setup** sheet of the printer driver. Then set **Prevention of Print Data Loss** to **On** in the dialog that appears.

* This may reduce print quality.



Ink Blots / Paper Curl

Ink Blots



Paper Curl



Check1 Check paper and print quality settings.

 [Print Results Are Unsatisfactory](#)

Check2 If intensity is set high, reduce intensity setting and try printing again.

If you are printing with a high intensity setting on plain paper, the paper may absorb too much ink and become wavy, causing paper abrasion.

Check the intensity setting in the printer driver.

- For Windows:

 [Adjusting Intensity](#)

- For Mac OS:

 [Adjusting Intensity](#)

Check3 Use Photo Paper to print photos.

To print data with high color saturation such as photographs or images with dark colors, we recommend that you use Photo Paper Plus Glossy II or other Canon specialty paper.

 [Media Types You Can Use](#)



Paper Is Smudged / Printed Surface Is Scratched

Paper Is Smudged

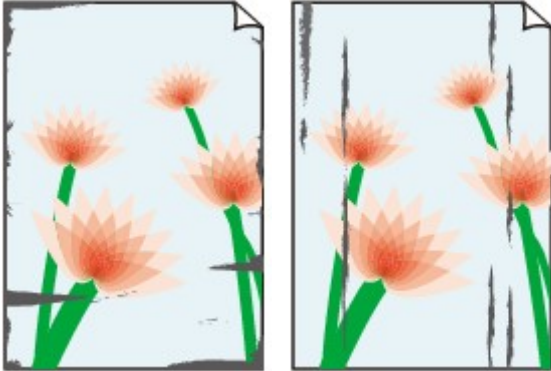

Smudged Edges

Smudged Surface



Printed Surface Is Scratched



Check1 Check paper and print quality settings.

[Print Results Are Unsatisfactory](#)

Check2 Check paper type.

- Make sure you are using the right paper for what you are printing.

[Media Types You Can Use](#)

- For borderless printing, use a paper suitable for borderless printing.

If the paper you are using is not suitable for borderless printing, the print quality may be reduced at the top and bottom edges of the paper.

[Printing Area](#)

Check3 Correct curl before loading paper.

When using Photo Paper Plus Semi-gloss, even if the sheet is curled, load one sheet at a time as it is. Rolling this paper in the opposite direction to flatten it may crack the paper surface and reduce the print quality.

We recommend putting unused paper back into the package and storing it flat.

- **Plain Paper**

Turn the paper over and reload it to print on the other side.

Leaving the paper loaded on the rear tray for a long time may cause the paper to curl. In this case, load the paper with the other side facing up. It may resolve the problem.

- **Other Paper**

If the paper corners curl more than 0.1 inch / 3 mm (A) in height, the paper may smudge or may not feed properly. Follow the instructions below to correct the paper curl.



1. Roll up paper in opposite direction to paper curl as shown below.



2. Check that paper is now flat.

We recommend printing curl-corrected paper one sheet at a time.

►► Note

- Depending on paper type, the paper may smudge or may not feed properly even if it is not curled inward. Follow the instructions below to curl the paper outward up to 0.1 inch / 3 mm (B) in height before printing. This may improve the print result.

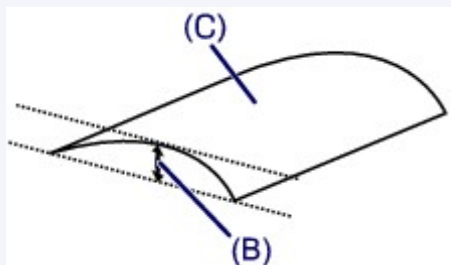

(C) Print side

We recommend feeding paper that has been curled outward one sheet at a time.

Check4 Set printer to prevent paper abrasion.

Adjusting the setting to prevent paper abrasion will widen the clearance between the print head and the paper. If you notice abrasion even with the media type set correctly to match the paper, set the machine to prevent paper abrasion using the operation panel or the computer.

This may reduce the print speed.

* Once you have finished printing, undo this setting. Otherwise, it will apply to subsequent print jobs.

- From operation panel

Press and hold the **Stop** button until the **Alarm** lamp flashes 15 times, and then release the button and press the **Color** button to enable the Prevent paper abrasion function.

To disable the Prevent paper abrasion function, press and hold the **Stop** button until the **Alarm** lamp flashes 15 times, and then release the button and press the **Black** button.

- From computer

- For Windows:

Open the printer driver setup window, select **Custom Settings** in **Maintenance** sheet, select **Prevent paper abrasion** check box, and then click **OK**.

To open the printer driver setup window, see [How to Open the Printer Driver Setup Window](#).

- For Mac OS:

In the Canon IJ Printer Utility, select **Custom Settings** in the pop-up menu, select **Prevent paper abrasion** check box, and then click **Apply**.

To open the Canon IJ Printer Utility, see [Opening the Canon IJ Printer Utility](#).

Check5 If intensity is set high, reduce intensity setting and try printing again.

If you are printing with a high intensity setting on plain paper, the paper may absorb too much ink and become wavy, causing paper abrasion.

Check the intensity setting in the printer driver.

- For Windows:

- [Adjusting Intensity](#)

- For Mac OS:

- [Adjusting Intensity](#)

Check6 Do not print outside recommended printing area.

If you print outside the recommended printing area of your paper, ink may stain the lower edge of the paper.

Resize the document using application software.

■ [Printing Area](#)

Check7 Is platen glass dirty?

Clean the platen glass.

■ [Cleaning the Platen Glass and Document Cover](#)

Check8 Is paper feed roller dirty?

Clean the paper feed roller.

■ [Cleaning the Paper Feed Roller](#)

▶▶▶ Note

- Cleaning the paper feed roller abrades it, so do this only when necessary.

Check9 Is inside of machine dirty?

During duplex printing, ink may stain the inside of the machine, smudging the printout.

Perform the bottom plate cleaning to clean the inside of the machine.

■ ■ [Cleaning the Inside of the Machine \(Bottom Plate Cleaning\)](#)

▶▶▶ **Note**

- To prevent staining inside the machine, be sure to set the correct paper size.

Check10 Set longer ink drying time.

This allows the printed surface to dry, preventing smudges and scratches.

- For Windows:
 1. Make sure machine is turned on.
 2. Open printer driver setup window.
 - ■ [How to Open the Printer Driver Setup Window](#)
 3. Click **Maintenance** tab and **Custom Settings**.
 4. Drag **Ink Drying Wait Time** slide bar to set wait time and click **OK**.
 5. Check message and click **OK**.
- For Mac OS:
 1. Make sure machine is turned on.
 2. Open Canon IJ Printer Utility.
 - ■ [Opening the Canon IJ Printer Utility](#)
 3. Select **Custom Settings** in pop-up menu.
 4. Drag **Ink Drying Wait Time**: slide bar to set wait time and click **Apply**.
 5. Check message and click **OK**.



Back of Paper Is Smudged

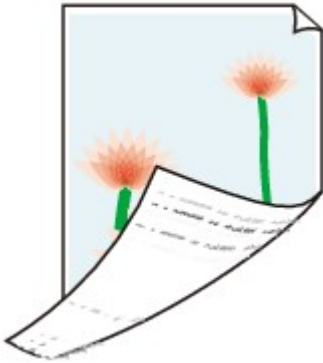

Check1 Check paper and print quality settings.

■ [Print Results Are Unsatisfactory](#)

Check2 Perform bottom plate cleaning to clean inside of machine.

■ [Cleaning the Inside of the Machine \(Bottom Plate Cleaning\)](#)

▶▶ Note

- During duplex printing or too much printing, ink may stain the inside of the machine.



Vertical Line Next to Image

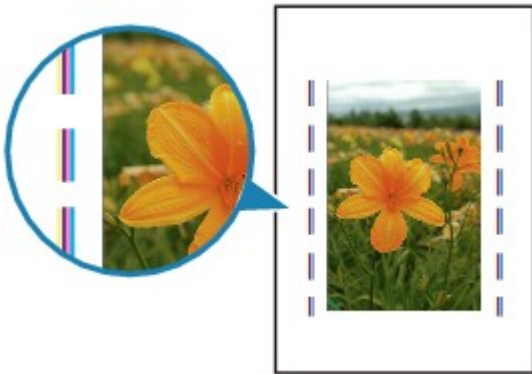

Check Is loaded paper size correct?

If the loaded paper is larger than the size you specified, a vertical line may appear in the margin. A small amount of ink is ejected for cleaning.

Set the paper size to match the loaded paper.

 [Print Results Are Unsatisfactory](#)

Note

- The direction of the vertical line pattern may vary depending on the image data or the print setting.
- This machine performs automatic cleaning when necessary to keep printouts clean.

Although the ink is normally ejected onto the ink absorber at the outer edge of the paper, it may get onto the paper if the loaded paper is larger than the set size.

Q

Uneven or Streaked Colors

▣ Uneven Colors



▣ Streaked Colors



A

Check1 Check paper and print quality settings.

■ [Print Results Are Unsatisfactory](#)

Check2 Print nozzle check pattern and perform any necessary maintenance operations such as print head cleaning.

Print the nozzle check pattern to determine whether the ink ejects properly from the print head nozzles.

For details on printing the nozzle check pattern, print head cleaning, and print head deep cleaning, see [If Printing Is Faint or Uneven](#).

- If nozzle check pattern is not printed correctly:

After performing the print head cleaning, print the nozzle check pattern and examine the pattern.

- If problem is not resolved after performing print head cleaning twice:
Perform print head deep cleaning.
- If problem is not resolved after performing print head deep cleaning:
Perform system cleaning.

- From computer:

- For Windows:

- [Cleaning the Print Heads](#)

- For Mac OS:

- [Cleaning the Print Heads](#)

- From operation panel:

To perform system cleaning, press and hold the **Stop** button until the **Alarm** lamp flashes 5 times, and then release the button.

▶▶▶ Important

- Before performing system cleaning, check the remaining ink level of all colors. If the remaining ink level is below the single dot (a), refill the ink tank of corresponding color. Performing system cleaning when the remaining ink level is not enough may damage the machine.



If the problem is not resolved yet, the print head may be damaged. Contact your nearest Canon service center to request a repair.

▶▶▶ Important

- Do not tilt the machine when moving it since the ink may leak out.
- When transporting the machine for repairing it, see [Repairing Your Machine](#).

Check3 Perform print head alignment.

■ [Aligning the Print Head](#)

▶▶▶ Note

- If the problem is not resolved after performing the print head alignment, perform print head alignment manually from your computer.
 - For Windows:
 - [Aligning the Print Head Position](#)
 - For Mac OS:
 - [Aligning the Print Head Position](#)



No Ink Comes Out



Check1 Check the remaining ink level.

■ [Checking Ink Status](#)

Check2 Are print head nozzles clogged?

Print the nozzle check pattern to determine whether the ink ejects properly from the print head nozzles.

For details on printing the nozzle check pattern, print head cleaning, and print head deep cleaning, see [If Printing Is Faint or Uneven](#).

- If nozzle check pattern is not printed correctly:

After performing the print head cleaning, print the nozzle check pattern and examine the pattern.

- If problem is not resolved after performing print head cleaning twice:

Perform print head deep cleaning.

- If problem is not resolved after performing print head deep cleaning:

Perform system cleaning.

- From computer:

- For Windows:

■ [Cleaning the Print Heads](#)

- For Mac OS:

■ [Cleaning the Print Heads](#)

- From operation panel:

To perform system cleaning, press and hold the **Stop** button until the **Alarm** lamp flashes 5 times, and then release the button.

►► Important

- Before performing system cleaning, check the remaining ink level of all colors. If the remaining ink level is below the single dot (a), refill the ink tank of corresponding color. Performing system cleaning when the remaining ink level is not enough may damage the machine.



If the problem is not resolved yet, the print head may be damaged. Contact your nearest Canon service center to request a repair.

»» Important

- Do not tilt the machine when moving it since the ink may leak out.
- When transporting the machine for repairing it, see [Repairing Your Machine](#).



Paper Does Not Feed Properly/"No Paper" Error



Check1 Make sure paper is loaded.

■ [Loading Paper](#)

Check2 When loading paper, consider the following.

- When loading two or more sheets of paper, align the edges of the sheets before loading the paper.
- When loading two or more sheets of paper, make sure the paper stack does not exceed the paper load limit.

However, paper may not feed correctly at the maximum capacity, depending on the type of paper or environmental conditions (very high or low temperature and humidity). In such cases, reduce the amount of paper you load at a time to less than half of the paper load limit.

- Always load the paper in portrait orientation, regardless of the printing orientation.
- When you load the paper, place the print side facing UP and slide the paper guides to align with both sides of the paper.

■ [Loading Paper](#)

Check3 Is paper too thick or curled?

■ [Media Types You Cannot Use](#)

Check4 When loading envelopes, consider the following:

When printing on envelopes, see [Loading Paper](#), and prepare the envelopes before printing.

Once you have prepared the envelopes, load them in portrait orientation. If the envelopes are placed in landscape orientation, they will not feed properly.

Check5 Make sure media type and paper size settings match with loaded paper.

Check6 Make sure there are not any foreign objects in rear tray.



If the paper tears in the rear tray, see [Paper Jams](#) to remove it.

If there are any foreign objects in the rear tray, be sure to turn off the machine, unplug it and remove the foreign object.



▶▶▶ Important

- Do not tilt the machine or do not it upside down. Doing so may cause the ink to leak.

Check7 Clean paper feed roller.

■ [Cleaning the Paper Feed Roller](#)

▶▶▶ Note

- Cleaning the paper feed roller abrades it, so do this only when necessary.

If the measures above do not solve the problem, contact your nearest Canon service center to request a repair.

▶▶▶ Important

- Do not tilt the machine when moving it since the ink may leak out.
- When transporting the machine for repairing it, see [Repairing Your Machine](#).



Copying/Printing Stops



Check1 Is paper loaded?

Make sure paper is loaded.

If necessary, load paper.

Check2 Do documents to be printed have many photographs or illustrations?

It takes time for the machine and the computer to process large data such as photos or other graphics, so it may seem that the machine is not working.

Also, if you are printing data that requires a lot of ink on successive sheets of plain paper, the machine may pause temporarily. In either case, wait until the process is complete.

▶▶▶ Note

- If you are printing a document with a large printing area or printing several copies, printing may pause to allow the ink to dry.

Check3 Has machine been printing continuously for a long period?

If the machine has been printing continuously for a long time, the print head or other parts around it may overheat. The machine may stop printing at a line break for a period of time and then resume printing.

In this case, wait a while without doing anything. If the printing does not resume, interrupt your print session and turn the machine off for at least 15 minutes.

⚠ Caution

- Print head and surrounding area can become extremely hot. Never touch print head or nearby components.

Check4 If copying stops before it is completed, retry copying.

If a certain time passes after some errors occurred while copying, the machine stops the operation.

Scanning Problems (Mac OS)

- ▶ **Scanning Problems**
- ▶ **Scan Results Are Unsatisfactory**
- ▶ **IJ Scan Utility Error Messages**
- ▶ **Scanner Driver Error Messages**

Scanning Problems

- ▶ **Scanner Does Not Work**
- ▶ **Scanner Driver Does Not Start**
- ▶ **Error Message Appears and the Scanner Driver Screen Does Not Appear**
- ▶ **Cannot Scan Multiple Originals at One Time**
- ▶ **Cannot Scan Properly with Auto Scan**
- ▶ **Slow Scanning Speed**
- ▶ **"There is not enough memory." Message Is Displayed**
- ▶ **Computer Stops Operating during Scanning**
- ▶ **Scanned Image Does Not Open**



Scanner Does Not Work



Check 1 Make sure that the scanner driver is installed.

Check 2 Connect the USB cable to a different USB port on the computer.

Check 3 If the USB cable is connected to a USB hub, remove it from the USB hub and connect it to a USB port on the computer.

Check 4 Restart the computer

Check 5 If one or more ink cartridges/tanks is low on ink or empty, the device's functions could be suspended. If this occurs, follow the instructions for resolving the [1640](#) support code.



Scanner Driver Does Not Start



Check 1 Make sure that the scanner driver is installed.

If not installed, install the scanner driver from the web page.

Check 2 Select your scanner or printer on the application's menu.

»» Note

- The operation may differ depending on the application.

Check 3 Make sure that the application supports the ICA (Image Capture Architecture) driver.

You cannot start the scanner driver from applications not supporting the ICA driver.

Check 4 Scan and save images with IJ Scan Utility and open the files in your application.



Error Message Appears and the Scanner Driver Screen Does Not Appear



Check 1 Make sure that your scanner or printer is turned on.

Check 2 Turn off your scanner or printer, then reconnect the USB cable and replug the power cord.

Check 3 Connect the USB cable to a different USB port on the computer.

Check 4 If the USB cable is connected to a USB hub, remove it from the USB hub and connect it to a USB port on the computer.

Check 5 Make sure that the scanner driver is installed.

If not installed, install the scanner driver from the web page.

Check 6 Select your scanner or printer on the application's menu.

▶▶▶ Note

- The operation may differ depending on the application.

Check 7 Make sure that the application supports the ICA driver.

You cannot start the scanner driver from applications not supporting the ICA driver.

Check 8 Exit the scanner driver if it is running on another application.



Cannot Scan Multiple Originals at One Time



Check 1 Make sure that the items are placed correctly.

■ [Positioning Originals \(Scanning from Computer\)](#)

Check 2 Check if you can properly scan one item.

Some applications do not support multiple image scanning. In that case, scan each item individually.



Cannot Scan Properly with Auto Scan



Check 1 Make sure that the items are placed correctly.

■ [Positioning Originals \(Scanning from Computer\)](#)

Check 2 Multiple item scanning may not be supported.

Some applications do not support multiple image scanning. In that case, scan each item individually.



Slow Scanning Speed



Check 1 To view the image on a monitor, set the output resolution to around 150 dpi. To print, set it to around 300 dpi.

■ [Resolution](#)

Check 2 Set **Fading Correction**, **Grain Correction**, etc. to **None**.

Refer to "[Image Corrections and Color Adjustments](#)" for details.

Check 3 In IJ Scan Utility, deselect the **Correct slanted text document / Detect the orientation of text document and rotate image** checkbox and scan again.

■ [Settings \(Document Scan\) Dialog](#)

■ [Settings \(Custom Scan\) Dialog](#)



"There is not enough memory." Message Is Displayed



Check 1 Exit other applications and try again.

Check 2 Reduce the resolution or output size and scan again.

■ [Resolution](#)



Computer Stops Operating during Scanning



Check 1 Restart the computer, reduce the output resolution and scan again.

■ [Resolution](#)

Check 2 Delete unnecessary files to obtain sufficient free hard disk space, then scan again.

Error message may appear if there is not enough hard disk space to scan and save, when the image size is too large (such as when scanning a large item at high resolution).

Check 3 In **Folder to Save Temporary Files** of IJ Scan Utility, specify a folder on a drive with sufficient free space.

■ [Settings \(General Settings\) Dialog](#)

Check 4 Multiple devices may be connected to USB ports.

Disconnect devices other than your scanner or printer.



Scanned Image Does Not Open



Check If the data format is not supported by the application, scan the image again and select a popular data format such as JPEG when saving it.

Refer to the application's manual for details. If you have any questions, contact the manufacturer of the application.

Scan Results Are Unsatisfactory

- ▶ **Scan Quality (Image Displayed on the Monitor) Is Poor**
- ▶ **Scanned Image Is Surrounded by Extra White Areas**
- ▶ **Cannot Scan at the Correct Size**
- ▶ **Original Is Placed Correctly, but the Scanned Image Is Slanted**
- ▶ **Scanned Image Is Enlarged (Reduced) on the Computer Monitor**



Scan Quality (Image Displayed on the Monitor) Is Poor



Check 1 Increase the scanning resolution if the image is jagged.

- [Resolution](#)
- [Settings Dialog](#)

Check 2 Set the display size to 100 %.

Some applications do not display images clearly if the display size is too small.

Check 3 If moire (stripe pattern) appears, take the following measures and scan again.

- Set one of the following settings in the **Settings (Document Scan)** dialog, **Settings (Custom Scan)** dialog, or **Settings (Scan and Stitch)** dialog of IJ Scan Utility, then scan from the IJ Scan Utility main screen.
 - Set **Select Source** to **Magazine** and set **Color Mode** to **Color**
 - Select the **Reduce moire** checkbox in **Image Processing Settings**

- [Settings \(Document Scan\) Dialog](#)
- [Settings \(Custom Scan\) Dialog](#)
- [Settings \(Scan and Stitch\) Dialog](#)

- Click **Driver** in the IJ Scan Utility main screen, then set one of the following settings.
 - Select **Magazine** for **Image Adjustment**
 - Select the **Descreen** checkbox

Refer to "[Image Corrections and Color Adjustments](#)" for details.

▶▶▶ Note

- If moire appears when you scan a digital print photo, take the above measures and scan again.

Check 4 Clean the platen and document cover.

Check 5 If the item is in poor condition (dirty, faded, etc.), click **Driver** in the IJ Scan Utility main screen, then set **Reduce Dust**, **Fading Correction**, **Grain Correction**, etc.

Refer to "[Image Corrections and Color Adjustments](#)" for details.

Check 6 If the color tone of images is different from the original document, take the following measures and scan again.

Click **Driver** in the IJ Scan Utility main screen, then set **Image Adjustment** to **None**.

Refer to "[Image Corrections and Color Adjustments](#)" for details.



Scanned Image Is Surrounded by Extra White Areas



Check Specify the scan area.

Manually specify the scan area when there are white margins or unwanted areas along the edges of the scanned images in the **Image Stitch** window.

■ [Adjusting Cropping Frames in the Image Stitch Window](#)



Cannot Scan at the Correct Size



Check Make sure that the items are placed correctly.

- [Positioning Originals \(Scanning from Computer\)](#)



Original Is Placed Correctly, but the Scanned Image Is Slanted



Check When **Document** or **Magazine** is selected for **Select Source**, deselect the **Correct slanted text document** checkbox and scan the item again.

■ [Settings \(Document Scan\) Dialog](#)

■ [Settings \(Custom Scan\) Dialog](#)



Scanned Image Is Enlarged (Reduced) on the Computer Monitor



Check 1 Change the display setting in the application.

Refer to the application's manual for details. If you have any questions, contact the manufacturer of the application.

Check 2 Click **Driver** in the IJ Scan Utility main screen, then change the resolution setting and scan again.

The higher the resolution, the larger the resulting image will be.

■ [Resolution](#)

IJ Scan Utility Error Messages

If an error message for IJ Scan Utility appears, check the error code and follow the corresponding solution.

Error Code	Error Message	Solution
152	There is not enough memory. Exit other applications to increase available memory.	<ul style="list-style-type: none"> The memory required to start IJ Scan Utility cannot be obtained; exit other applications.
153	The image you attempted to scan is in a size that cannot be opened in the specified application. Change the settings so that the image size is reduced.	<ul style="list-style-type: none"> Reduce the resolution or output size and scan again.
157	<p>Cannot communicate with scanner for these reasons:</p> <ul style="list-style-type: none"> - Scanner is turned off. - (If using Wired LAN connection) It is disconnected from Wired LAN. - (If using wireless LAN connection) Signal strength is poor due to obstructions. - Network connection is prohibited by security software. - Different scanner on the network is selected. <p>Check the above and try scanning again. If you still cannot communicate, restart the computer.</p>	<ul style="list-style-type: none"> With network connection, check the connection status and reconnect as required. If the same error message still appears, restart the computer.
201	A required file is missing or corrupted, or settings are incorrect. Try the installation again.	<ul style="list-style-type: none"> Reinstall the scanner driver from the web page. Reinstall IJ Scan Utility from the web page.
202	<p>An internal error has occurred. Take the following measures.</p> <ul style="list-style-type: none"> - Check the scanner status. - Restart the scanner. - Restart the computer, then try again. - Reinstall the scanner driver. 	<ul style="list-style-type: none"> An internal error has occurred. Take the following measures. <ul style="list-style-type: none"> Check the scanner status. Restart the scanner. Restart the computer, then try again. Reinstall the scanner driver.
230	A scanner driver supporting this software is not installed. Install it and try again.	<ul style="list-style-type: none"> Reinstall the scanner driver from the web page.
231	Cannot complete the scan. The disk space is insufficient.	<ul style="list-style-type: none"> Delete unnecessary files on the hard disk and scan again.
232	<p>Cannot save the file. The disk is write-protected.</p> <p>Cancel the protection or use another disk.</p>	<ul style="list-style-type: none"> Cancel the write protection on the disk.

242	Cannot write file.	<ul style="list-style-type: none"> • Check the access permission on the folder in Folder to Save Temporary Files in the Settings (General Settings) dialog or Save in in the corresponding Settings dialog .
243	Cannot read file.	<ul style="list-style-type: none"> • Check the access permission on the folder in Folder to Save Temporary Files in the Settings (General Settings) dialog or Save in in the corresponding Settings dialog .
244	You do not have the required privileges to access the specified folder.	<ul style="list-style-type: none"> • Grant access permission to the specified folder.

Scanner Driver Error Messages

Error Message	Solution
<p>Error in scanner. See the manual for solutions.</p>	<ul style="list-style-type: none"> • Make sure that your scanner or printer and the computer are connected correctly. • Your scanner or printer may be damaged. <p>Restart the computer, then reconnect your scanner. If the same error message still appears, contact the service center.</p>
<p>USB connection:</p> <p>Cannot communicate with scanner for these reasons:</p> <ul style="list-style-type: none"> - Scanner is turned off. - USB cable is disconnected. <p>Please check and try again.</p>	<ul style="list-style-type: none"> • Make sure that your scanner or printer is turned on. • Make sure that the selected scanner is correct. Refer to the application's manual for details. • With USB connection, check the connection of the USB cable and reconnect as required.
<p>Network connection:</p> <p>Cannot communicate with scanner for these reasons:</p> <ul style="list-style-type: none"> - Scanner is turned off. - (If using Wired LAN connection) It is disconnected from Wired LAN. - (If using wireless LAN connection) Signal strength is poor due to obstructions. - Network connection is prohibited by security software. - Different scanner on the network is selected. <p>Please check and try again.</p>	<ul style="list-style-type: none"> • With network connection, check the connection status and reconnect as required.
<p>A required file is missing or corrupted, or settings are incorrect. Try the installation again.</p>	<ul style="list-style-type: none"> • Reinstall the scanner driver from the web page.
<p>Cannot write or read file.</p>	<ul style="list-style-type: none"> • Exit running applications, check that there is sufficient free space on the hard disk, then scan again. • Make sure that there is no problem with the destination folder, file name, or access permission.
<p>There is not enough free disk space to complete the scan.</p>	<ul style="list-style-type: none"> • Delete unnecessary files on the hard disk and scan again.
<p>Printer is in use or an error has occurred. Check status.</p>	<ul style="list-style-type: none"> • If you are attempting to SCAN while the printer is performing another operation, please wait for that operation to finish. If you are attempting to SCAN while a support code is displayed on the printer, please locate the support code number on the page entitled "List of Support Code for Error" and follow the instructions to address and resolve the support code.
<p>The scanner is not available while in use by another application or user.</p>	<ul style="list-style-type: none"> • Close the other application.

Mechanical Problems

- ▶ **Power Does Not Come On**
- ▶ **Power Shuts Off By Itself**
- ▶ **Cannot Connect to Computer Properly**
- ▶ **Printer Status Monitor Not Displayed (Windows)**



Power Does Not Come On



Check1 Press **ON** button.

Check2 Make sure power plug is securely connected to machine, and then turn it back on.

Check3 Unplug machine, leave it for at least 2 minutes, and then plug it back in and turn it on again.

If this does not solve the problem, contact your nearest Canon service center to request a repair.

»» Important

- Do not tilt the machine when moving it since the ink may leak out.
- When transporting the machine for repairing it, see [Repairing Your Machine](#).



Power Shuts Off By Itself



Check If machine is set to turn off automatically after a certain time, disable this setting.

If you have set the machine to turn off automatically after a specified time, the power will shut off by itself once that time has elapsed.

- If you are using a Windows and if you do not want the machine to turn off automatically:
Open the printer driver setup window and in **Auto Power** in **Maintenance** sheet, select **Disable** for **Auto Power Off**.
- If you are using a Mac OS and if you do not want the machine to turn off automatically:
Open Canon IJ Printer Utility, select **Power Settings** in the pop-up menu, and then select **Disable** for **Auto Power Off** on **Auto Power**.

▶▶▶ Note

- You can also enable the machine to turn on/off automatically from the operation panel.
 - [Turning on/off Machine Automatically](#)
- If you are using a Windows, you can also enable the machine to turn on/off automatically from ScanGear (scanner driver).
 - [Scanner Tab](#)

Cannot Connect to Computer Properly

Q Printing or Scanning Is Slow/Hi-Speed USB Connection Does Not Work/"This device can perform faster" Message Appears (Windows)

A

If your system environment does not support Hi-Speed USB, the machine operates at the slower speed of USB 1.1. In this case, the machine works properly but printing or scanning speed may slow down due to the communication speed.

Check

Check following to make sure your system environment supports Hi-Speed USB connection.

- Does the USB port on your computer support Hi-Speed USB connection?
- Does the USB cable or the USB hub support Hi-Speed USB connection?

Be sure to use a certified Hi-Speed USB cable. We recommend that the USB cable be no longer than 10 feet / 3 meters or so.

- Does the operating system of your computer support Hi-Speed USB connection?

Install the latest update for your computer.

- Is the Hi-Speed USB driver working properly?

If necessary, obtain and install the latest version of the Hi-Speed USB driver for your computer.

»» Important

- For more information, contact the manufacturer of your computer, USB cable, or USB hub.



Printer Status Monitor Not Displayed (Windows)



Check Is printer status monitor enabled?

Make sure **Enable Status Monitor** is selected on the **Option** menu of the printer status monitor.

1. Open printer driver setup window.
 - [How to Open the Printer Driver Setup Window](#)
2. On **Maintenance** sheet, click **View Printer Status**.
3. Select **Enable Status Monitor** on **Option** menu if it is not selected.

Installation and Download Problems

- ▶ [Cannot Install MP Drivers](#)
- ▶ [Easy-WebPrint EX Does Not Start or Easy-WebPrint EX Menu Does Not Appear \(Windows\)](#)



Cannot Install MP Drivers



■ [For Windows:](#)

■ [For Mac OS:](#)

For Windows:

- **If installation does not start when you insert Setup CD-ROM:**

Follow the instructions below to start the installation.

1. Make the following settings.

- In Windows 10, click **Start** button > **File Explorer**, and then click **This PC** from list on left.
- In Windows 8.1 or Windows 8, select **Explorer** icon in **Taskbar** on **Desktop**, and then select **This PC (Computer for Windows 8)** from list on left.
- In Windows 7 or Windows Vista, click **Start**, and then click **Computer**.
- In Windows XP, click **Start**, and then click **My Computer**.

2. Double-click  **CD-ROM** icon in the window that appears.

If the contents of the CD-ROM appear, double-click **MSETUP4.EXE**.

If you cannot install the MP Drivers with the Setup CD-ROM, install them from the Canon website.

▶▶ Note

- If the CD-ROM icon does not appear, try the following:
 - Remove the CD-ROM from your computer and reinsert it.
 - Restart your computer.

If the icon still does not appear, try a different disc and see if it appears. If it does, there is a problem with the Setup CD-ROM. Contact your nearest Canon service center to request a repair.

- If you cannot get past the Printer Connection screen:



■ Cannot Proceed beyond Printer Connection Screen

- Other cases:

Reinstall the MP Drivers.

If the MP Drivers were not installed correctly, uninstall the MP Drivers, restart your computer, and then reinstall the MP Drivers.

■ Deleting the Unnecessary MP Drivers

Reinstall the MP Drivers with the Setup CD-ROM or install them from the Canon website.

▶▶▶ Note

- If the installer was stopped due to a Windows error, Windows operation may be unstable, and you may not be able to install the drivers. Restart your computer and then reinstall the drivers.

For Mac OS:

Download the drivers from the support page of Canon website and reinstall it.



Easy-WebPrint EX Does Not Start or Easy-WebPrint EX Menu Does Not Appear (Windows)



If Easy-WebPrint EX does not start or its menu does not appear on Internet Explorer, check the following.

Check1 Is **Canon Easy-WebPrint EX** displayed on **Toolbars** menu in Internet Explorer's **View** menu?

If **Canon Easy-WebPrint EX** is not displayed, Easy-WebPrint EX is not installed on your computer. Install the latest version of Easy-WebPrint EX from the Canon website.

»» Note

- If Easy-WebPrint EX is not installed, a message asking you to install it may appear in the notification area on the desktop. Click the message and follow the instructions to install Easy-WebPrint EX.
- Internet access is required to install or download Easy-WebPrint EX.

Check2 Is **Canon Easy-WebPrint EX** selected on **Toolbars** menu in Internet Explorer's **View** menu?

If **Canon Easy-WebPrint EX** is not selected, Easy-WebPrint EX is disabled. Select **Canon Easy-WebPrint EX** to enable it.

Check3 Check the following to make sure your system environment supports Easy-WebPrint EX.

- Is it installed on the computer with proper system requirements?
- Did you start it using a compatible version of Internet Explorer?

Visit Canon website for more information of the system requirements of Easy-WebPrint EX.

Errors and Messages

- **An Error Occurs**
- **Message Appears**
- **"The printer is performing another operation" Appears on Computer Screen**

An Error Occurs

If an error occurs in printing, for example if the paper runs out or jams, a troubleshooting message appears automatically. Take the appropriate action described in the message.

When an error occurs, the **Alarm** lamp flashes and a support code (error number) appears on the computer screen. For some errors, the **Alarm** lamp and the **ON** lamp flashes alternately. Check the status of the lamps and the message, and take the appropriate action.

Support Code Corresponding to Number of Flashes of Alarm Lamp

Example of 2 times flashing:



(A) Flashes

(B) Goes off

Number of flashes	Cause	Support Code
2 flashes	Machine is out of paper or paper does not feed.	1000
3 flashes	Paper is jammed in paper output slot or in rear tray.	1300
4 flashes	Cartridge is not installed properly.	1470
5 flashes	Print head may be damaged.	1403
	Cartridge cannot be recognized.	1471
	Appropriate cartridge is not installed.	1476
7 flashes	Cartridge is not installed in correct position.	1474
	More than one cartridge of the same color is installed.	1475
8 flashes	Ink absorber is almost full.	1700 , 1701
9 flashes	Protective material or tape may still be attached to cartridge holder.	1890
14 flashes	Cartridge cannot be recognized.	1473
15 flashes	Cartridge cannot be recognized.	1472

Support Code Corresponding to Number of Alternate Flashes of ON Lamp and Alarm Lamp

Example of 2 times flashing:



(A) Alternately flashes

(B) Goes off

Number of flashes	Cause	Support Code
2 flashes	Printer error has occurred.	5100
7 flashes	Printer error has occurred.	5B00 , 5B01
10 flashes	An error requiring a repair has occurred.	B202 , B203 , B204 , B205
Other cases than above	Printer error has occurred.	5011 , 5012 , 5050 , 5200 , 5400 , 5700 , 6800 , 6801 , 6930 , 6931 , 6932 , 6933 , 6936 , 6937 , 6938 , 6940 , 6941 , 6942 , 6943 , 6944 , 6945 , 6946

When a Support Code and a Message Are Displayed on Computer Screen:

- For Windows:

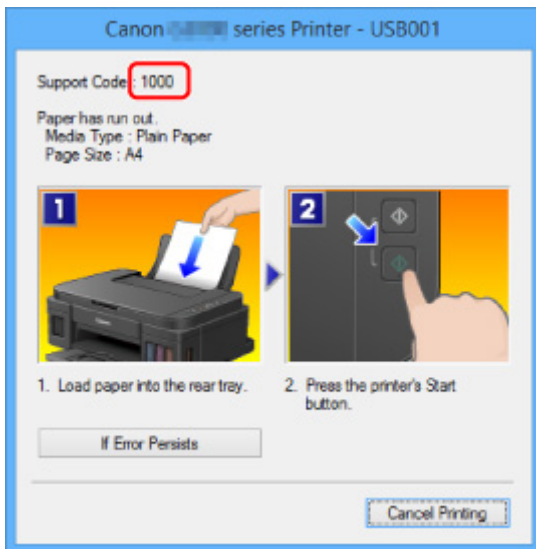

- For Mac OS:

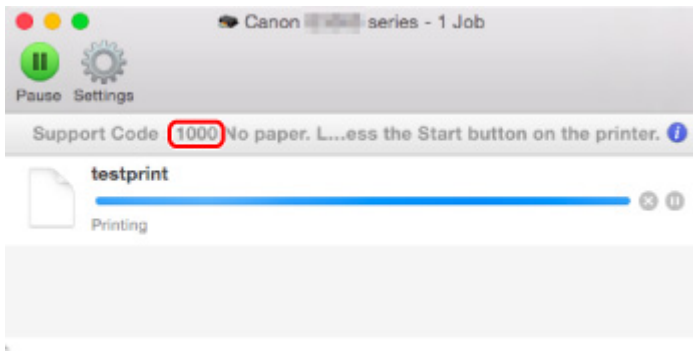

* The screen differs depending on the OS you are using.

▶▶ Note

- You can also search for details on resolving the errors indicated by the support code shown.

■ [Search](#)

To resolve errors that do not have support codes, see [Message Appears](#).

Message Appears

This section describes some of the errors and messages that may appear.

►►► Note

- A support code (error number) is displayed on the computer for some errors. For details on errors that have support code, see [List of Support Code for Error](#).

■ [Error Regarding Power Cord Being Unplugged Is Displayed \(Windows\)](#)

■ [Writing Error/Output Error/Communication Error \(Windows\)](#)

■ [Other Error Messages \(Windows\)](#)

■ [Inkjet Printer/Scanner/Fax Extended Survey Program Screen Is Displayed \(Windows\)](#)

■ [Inkjet Printer/Scanner/Fax Extended Survey Program Icon Appears \(Mac OS\)](#)



Error Regarding Power Cord Being Unplugged Is Displayed (Windows)



The machine may have been unplugged while it was on.

Check the error message that appears on the computer and click **OK**.

The machine starts printing.

See [Notice for Unplugging the Power Cord](#) for unplugging the power cord.



Writing Error/Output Error/Communication Error (Windows)



Check1 If **ON** lamp is off, make sure machine is plugged in and turn it on.

The **ON** lamp flashes while the machine is initializing. Wait until the **ON** lamp stops flashing and remains lit.

Check2 Make sure correct printer port is set in printer driver.

* In the following instructions, "XXX" signifies your machine's name.

1. Log in using an account with administrator privileges.
2. Make the following settings.
 - In Windows 10, right-click **Start** button and select **Control Panel > View devices and printers**.
 - In Windows 8.1 or Windows 8, select **Control Panel** from **Settings** charm on **Desktop > Hardware and Sound > Devices and Printers**.
 - In Windows 7, select **Devices and Printers** from **Start** menu.

- In Windows Vista, select **Start** menu > **Control Panel** > **Hardware and Sound** > **Printers**.
 - In Windows XP, select **Start** menu > **Control Panel** > **Printers and Other Hardware** > **Printers and Faxes**.
3. Open printer driver properties.
- In Windows 10, Windows 8.1, Windows 8, or Windows 7, right-click "Canon XXX series Printer" icon (where "XXX" is your machine's name), and then select **Printer properties**.
 - In Windows Vista or Windows XP, right-click "Canon XXX series Printer" icon (where "XXX" is your machine's name), and then select **Properties**.
4. Click **Ports** tab to check port settings.

Make sure a port named "USBnnn" (where "n" is a number) with "Canon XXX series Printer" appearing in **Printer** column is selected for **Print to the following port(s)**.

- If setting is incorrect:

Reinstall the MP Drivers from the Setup CD-ROM or the Canon website.

- If printing does not start even though the machine is connected to the computer using a USB cable and the port named "USBnnn" is selected:

In Windows 10, click **Start** button and select **All apps**, **Canon Utilities**, **Canon My Printer**, **Canon My Printer**, and then select **Diagnose and Repair Printer**. Follow the on-screen instructions to set the correct printer port, and then select your machine's name.

In Windows 8.1 or Windows 8, select **My Printer** on **Start** screen to start **My Printer**. If **My Printer** is not displayed on **Start** screen, select **Search** charm, and then search for "**My Printer**".

Set the correct printer port on **Diagnose and Repair Printer**. Follow the on-screen instructions to set the correct printer port, and then select your machine's name.

In Windows 7, Windows Vista, or Windows XP, click **Start** and select **All programs**, **Canon Utilities**, **Canon My Printer**, **Canon My Printer**, and then select **Diagnose and Repair Printer**. Follow the on-screen instructions to set the correct printer port, and then select your machine's name.

If the problem is not resolved, reinstall the MP Drivers from the Setup CD-ROM or the Canon website.

Check3 Make sure USB cable is securely plugged in to machine and computer.

When the machine is connected to your computer with a USB cable, check the following:

- If you are using a relay device such as a USB hub, disconnect it, connect the machine directly to the computer, and retry the printing. If printing starts normally, there is a problem with the relay device. Contact the vendor of the relay device.
- There could also be a problem with the USB cable. Replace the USB cable and retry the printing.

Check4 Make sure MP Drivers are installed correctly.

Uninstall the MP Drivers following the procedure described in Deleting the Unnecessary MP Drivers and reinstall them from the Setup CD-ROM or the Canon website.

Check5 When machine is connected to your computer with a USB cable, check device status from your computer.

Follow the procedure below to check the device status.

1. Open the Device Manager on your computer as shown below.

If the **User Account Control** screen appears, follow the on-screen instructions.

- In Windows 10, right-click **Start** button and select **Device Manager**.
- In Windows 8.1 or Windows 8, select **Control Panel** from **Settings** charm on **Desktop > Hardware and Sound > Device Manager**.
- In Windows 7 or Windows Vista, click **Control Panel, Hardware and Sound, and Device Manager**.
- In Windows XP, click **Control Panel, Performance and Maintenance, System, and Device Manager** on **Hardware** sheet.

2. Double-click **Universal Serial Bus controllers** and **USB Printing Support**.

If the **USB Printing Support Properties** screen does not appear, make sure the machine is correctly connected to the computer.

 **Check3** [Make sure USB cable is securely plugged in to machine and computer.](#)

3. Click **General** tab and check for a device problem.

If a device error is shown, see Windows Help to resolve it.

Other Error Messages (Windows)

 **Check** If an error message appears outside printer status monitor, check the following:

- **"Could not spool successfully due to insufficient disk space"**
Delete any unnecessary files to increase the amount of free space on the disk.
- **"Could not spool successfully due to insufficient memory"**
Close other applications to increase the available memory.
If you still cannot print, restart your computer and retry the printing.
- **"Printer driver could not be found"**
Uninstall the MP Drivers following the procedure described in [Deleting the Unnecessary MP Drivers](#) and reinstall them from the Setup CD-ROM or the Canon website.
- **"Could not print Application name - File name"**
Try printing again once the current job is complete.

Inkjet Printer/Scanner/Fax Extended Survey Program Screen Is Displayed (Windows)

###

If the Inkjet Printer/Scanner/Fax Extended Survey Program is installed, a screen appears asking for permission to send the machine and application usage information every month for about ten years.

Read the information on the screen and follow the instructions below.

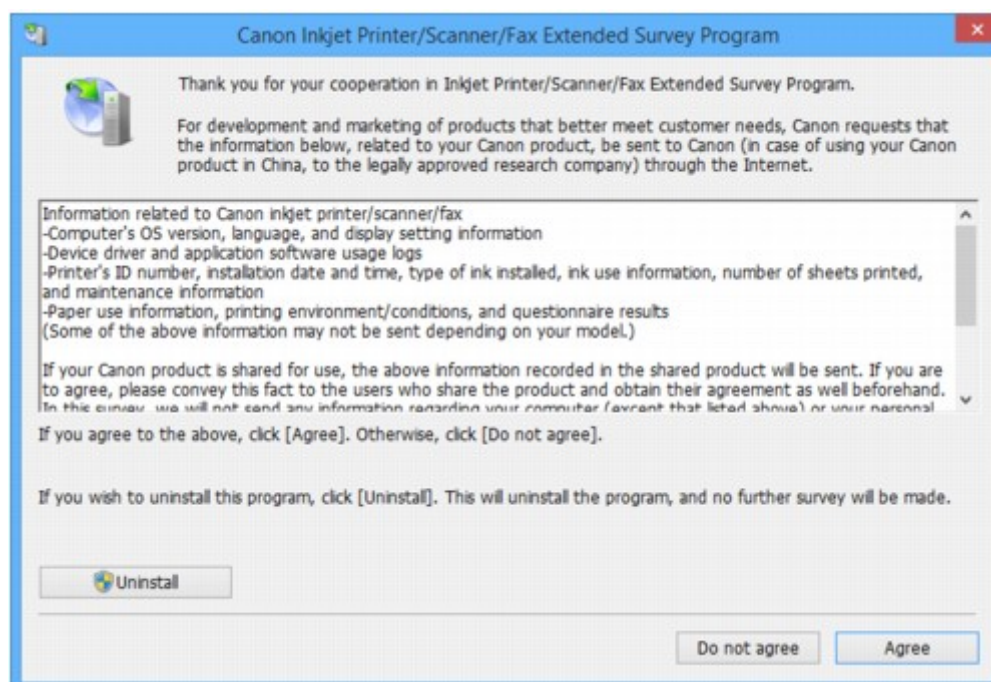

- **If you agree to participate in survey program:**

Click **Agree** and follow the on-screen instructions. The printer usage information is sent via the Internet. Once you have completed the procedure, the information is subsequently sent automatically and the confirmation screen does not reappear.

►►► Note

- When the information is being sent, a warning such as an Internet security message may appear. Make sure the program name is "IJPLMUI.exe" and allow it.
- If you clear **Send automatically from the next time** check box, the information will not be sent automatically from next time and a confirmation screen will appear at the time of the next survey. To send the information automatically, see [Changing confirmation screen setting](#).

- **If you do not agree to participate in survey program:**

Click **Do not agree**. The confirmation screen closes and the survey is skipped. The confirmation screen will reappear one month later.

- **To uninstall Inkjet Printer/Scanner/Fax Extended Survey Program:**

To uninstall the Inkjet Printer/Scanner/Fax Extended Survey Program, click **Uninstall** and follow the on-screen instructions.

- **Changing confirmation screen setting:**

1. Make the following settings.

- In Windows 10, right-click **Start** button and select **Programs and Features**.

- In Windows 8.1 or Windows 8, select **Control Panel** from **Settings** charm on **Desktop** > **Programs** > **Programs and Features**.
- In Windows 7, or Windows Vista, select **Start** menu > **Control Panel** > **Programs** > **Programs and Features**.
- In Windows XP, select **Start** menu > **Control Panel** > **Add or Remove Programs**.

»» Note

- In Windows 10, Windows 8.1, Windows 8, Windows 7, or Windows Vista, a confirmation/warning dialog box may appear when installing, uninstalling or starting up software.
This dialog box appears when administrative rights are required to perform a task.
If you are logged in on an account with administrator privileges, follow the on-screen instructions.

2. Select **Canon Inkjet Printer/Scanner/Fax Extended Survey Program**.
3. Select **Change**.

If you select **Yes** after you have followed the on-screen instructions, the confirmation screen will appear at the time of the next survey.

If you select **No**, the information will be sent automatically.

»» Note

- If you select **Uninstall** (or **Remove** in Windows XP), the Inkjet Printer/Scanner/Fax Extended Survey Program is uninstalled. Follow the on-screen instructions.

Inkjet Printer/Scanner/Fax Extended Survey Program Icon Appears (Mac OS)

A

If the Inkjet Printer/Scanner/Fax Extended Survey Program is installed, the printer and application software usage information is sent every month for about ten years. The **Inkjet Printer/Scanner/Fax Extended Survey Program** icon appears in the Dock when it is time to send the printer usage information.

Click the icon, read the information that appears, and then follow the instructions below.

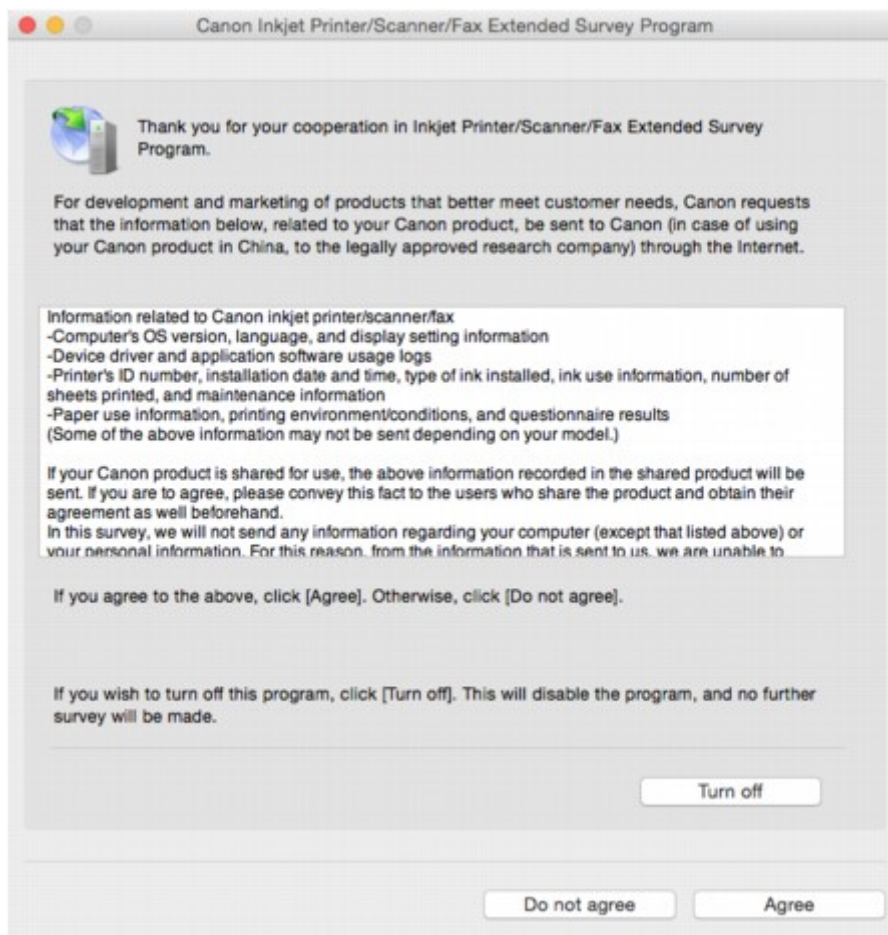

- **If you agree to participate in survey program:**

Click **Agree** and follow the on-screen instructions. The printer usage information is sent via the Internet. Once you have completed the procedure, the information is subsequently sent automatically and the confirmation screen does not reappear.

▶▶▶ **Note**

- If you clear **Send automatically from the next time** check box, the information will not be sent automatically the next time and the **Inkjet Printer/Scanner/Fax Extended Survey Program** icon will appear in the dock at the time of the next survey.

- **If you do not agree to participate in survey program:**

Click **Do not agree**. The confirmation screen closes and the survey is skipped. The confirmation screen will reappear one month later.

- **To stop sending information:**

Click **Turn off**. This stops the Inkjet Printer/Scanner/Fax Extended Survey Program, and information is not sent. To resume the survey, see [Changing setting](#).

- **To uninstall Inkjet Printer/Scanner/Fax Extended Survey Program:**

1. Stop Inkjet Printer/Scanner/Fax Extended Survey Program.

■ [Changing setting](#):

2. Select **Applications** from **Go** menu of Finder, double-click **Canon Utilities** folder and **Inkjet Extended Survey Program** folder.
3. Move **Canon Inkjet Printer/Scanner/Fax Extended Survey Program.app** file to **Trash**.
4. Restart computer.
Empty **Trash** and restart your computer.

- **Changing setting:**

To display the confirmation screen every time the printer usage information is sent or to resume surveying, follow the procedure below.

1. Select **Applications** from **Go** menu of Finder, double-click **Canon Utilities** folder and **Inkjet Extended Survey Program** folder.
2. Double-click **Canon Inkjet Printer/Scanner/Fax Extended Survey Program** icon.

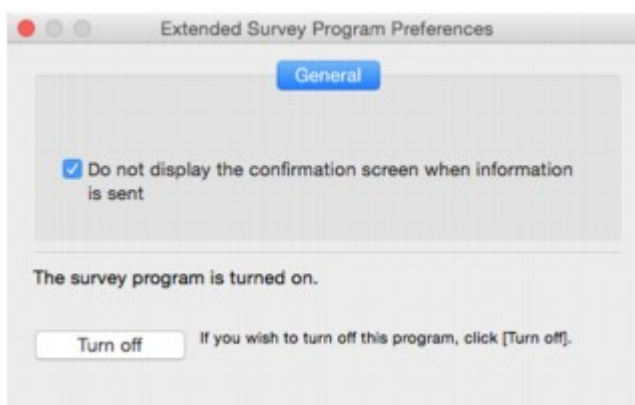

- **Do not display the confirmation screen when information is sent:**

If the check box is selected, the information will be sent automatically.

If the check box is not selected, **Inkjet Printer/Scanner/Fax Extended Survey Program** icon will appear in the Dock at the time of the next survey. Click the icon and follow the on-screen instructions.

- **Turn off/Turn on** button:

Click the **Turn off** button to stop the Inkjet Printer/Scanner/Fax Extended Survey Program.

Click the **Turn on** button to restart the Inkjet Printer/Scanner/Fax Extended Survey Program.



"The printer is performing another operation" Appears on Computer Screen



Check1 Printer installation may not be complete.

Refer to the printed manual "*Getting Started*" and complete the printer installation.

»» Note

- During installation, the printer requires the operation that ink is loaded into the inside of printer from the ink tank. This operation takes about 6 minutes to complete. Wait until the operation is complete.

Check2 This message may appear while the printer is in operation.

This message closes when the operation is complete. Wait until the operation is complete.

If You Cannot Solve a Problem

If there is a problem that you cannot solve following the instructions in this chapter, contact Canon through the Support page of the Canon website or contact your nearest Canon service center.

Canon support staff are trained to be able to provide technical support to satisfy customers.

Caution

- If the machine emits any unusual sound, smoke, or odor, turn it off immediately. Unplug the machine and contact the seller you bought it from or your nearest Canon service center. Never attempt to repair or disassemble the machine yourself.
- If you attempt to repair or take apart the machine, your warranty will be invalidated even if it has not expired.

Before contacting the service center, note the following:

- Product name
(Your machine's name is written on the front cover of the setup manual.)
- Serial number (see setup manual)
- Details of problem
- What you tried to solve the problem, and what happened

Repairing Your Machine

When transporting the machine for repairing it, follow the procedure below to prepare.

▶▶ Important

- When transporting the machine, make sure to avoid the followings.
 - You cannot take ink out of ink tanks.
 - Do not tilt the machine. Ink may leak.
 - Please handle with care and ensure the box remains flat and NOT turned upside down or on its side, as the printer may be damaged and ink in the printer may leak.
 - Pack the machine in a sturdy box so that it is placed with its bottom facing down, using sufficient protective material to ensure safe transport.
 - Do not remove the cartridge. Ink may leak.
 - When transporting the machine, we recommend packing the machine in a plastic bag so that ink does not leak.
 - When a shipping agent is handling transport of the machine, have its box marked "THIS SIDE UP" to keep the machine with its bottom facing down. Mark also with "FRAGILE" or "HANDLE WITH CARE".

1. [Make sure machine is turned on.](#)

If the machine cannot be turned on, unplug it and go to step 4.

2. If an error has occurred, press machine's **Black** or **Color** button.

After the **Alarm** lamp is turned off, go to step 3.

If the error is not cleared, press **ON** button to turn the machine off, and then unplug it. If the machine cannot be turned off, unplug it. Go to step 4.

3. Set machine to transporting mode.

Press and hold **Stop** button, and then release button when **Alarm** lamp flashes 7 times. The machine is set to transporting mode and turned off. Unplug the machine.

4. Make sure that cartridge holder has moved to far right.

If the cartridge holder is not to the right, move it to far right.

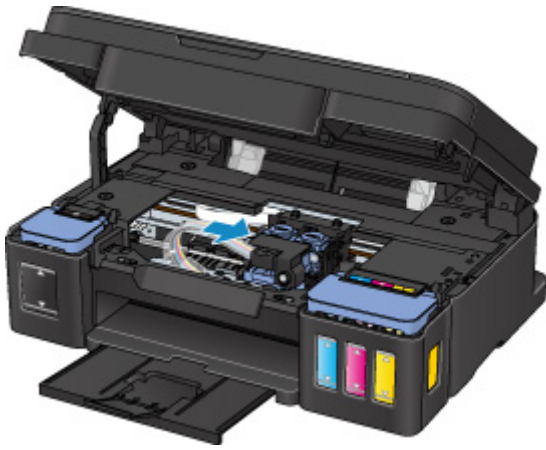

5. Make sure that tank caps are properly closed.

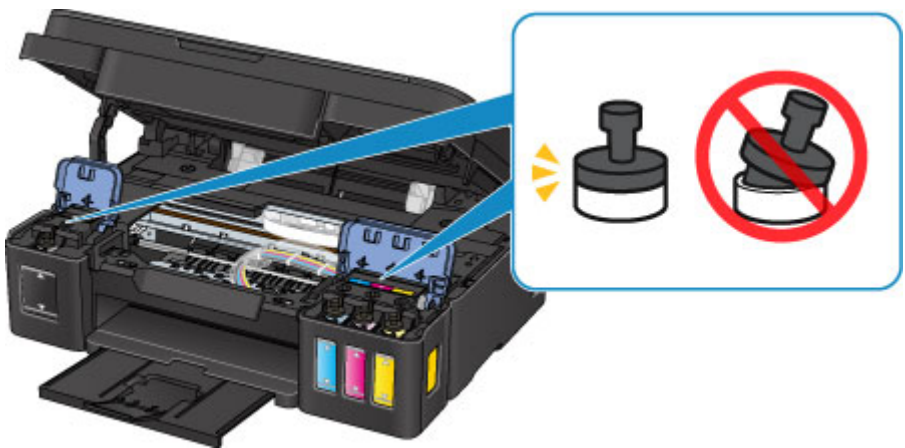

6. Retract the paper output tray and output tray extension, and then close the paper support.

7. Unplug the printer cable from the computer and from the machine, then unplug the power cord from the machine.

8. Use adhesive tape to secure all the covers on the machine to keep them from opening during transportation. Then pack the machine in the plastic bag.



9. Attach the protective material to the machine when packing the machine in the box.

List of Support Code for Error

Support code appears on your computer screen when errors occur.

A "support code" is an error number, and appears along with an error message.

When an error occurs, check the support code displayed on the computer screen and take the appropriate action in response.

Support Code Appears on Computer Screen

- **1000 to 1ZZZ**

[1000](#) [1200](#) [1300](#) [1403](#) [1470](#) [1471](#)

[1472](#) [1473](#) [1474](#) [1475](#) [1476](#) [1640](#)

[1700](#) [1701](#) [1890](#)

- **2000 to 2ZZZ**

[2900](#) [2901](#)

- **5000 to 5ZZZ**

[5011](#) [5012](#) [5050](#) [5100](#) [5200](#) [5400](#)

[5700](#) [5B00](#) [5B01](#)

- **6000 to 6ZZZ**

[6000](#) [6800](#) [6801](#) [6930](#) [6931](#) [6932](#)

[6933](#) [6936](#) [6937](#) [6938](#) [6940](#) [6941](#)

[6942](#) [6943](#) [6944](#) [6945](#) [6946](#)

- **A000 to ZZZZ**

[B202](#) [B203](#) [B204](#) [B205](#)

For paper jam support codes, see also [List of Support Code for Error \(Paper Jams\)](#).

List of Support Code for Error (Paper Jams)

If paper jams, remove it following the appropriate procedure as shown below.

- If you can see the jammed paper at the paper output slot or the rear tray:

- [1300](#)

- If the paper tears and you cannot remove it from the paper output slot or from the rear tray:

- [Paper Is Jammed inside Machine](#)

- Cases other than above:

- [Other Cases](#)

1300

Cause

Paper is jammed in paper output slot or in rear tray.

What to Do

Remove the jammed paper following the procedure below.

1. Slowly pull out paper, either from paper output slot or from rear tray, whichever is easier.

Hold the paper with both hands, and pull it out slowly so as not to tear it.



▶▶▶ Note

- If you cannot pull out the paper, turn the machine back on. The paper may be ejected automatically.
- If paper becomes jammed during printing and you need to turn off the machine to remove it, press the **Stop** button to stop the printing before you turn off the machine.
- If the paper tears and you cannot remove the jammed paper from the paper output slot or the rear tray, remove the paper from inside the machine.

■ [Paper Is Jammed inside Machine](#)

2. Reload paper and press machine's **Black** or **Color** button.

The printer resumes printing. Reprint the page you were printing if it was not printed properly due to the paper jam.

If you turned off the machine in step 1, the print data that was sent to the machine is erased. Redo the printing.

▶▶▶ Note

- When reloading the paper, make sure you are using suitable paper and loading it correctly.
- We recommend using paper sizes other than A5 to print documents with photos or graphics. A5 paper may curl and jam as it leaves the machine.

Paper Is Jammed inside Machine

If the jammed paper tears and you cannot remove the paper either from the paper output slot or from the rear tray, or if the jammed paper remains inside the machine, remove the paper following the instructions below.

▶▶▶ Note

- If paper becomes jammed during printing and you need to turn off the machine to remove it, press the **Stop** button to stop the printing before you turn off the machine.

1. Turn off machine and unplug it.
2. Open scanning unit / cover.



▶▶▶ Important

- Do not touch clear film (A), white belt (B), or tubes (C).

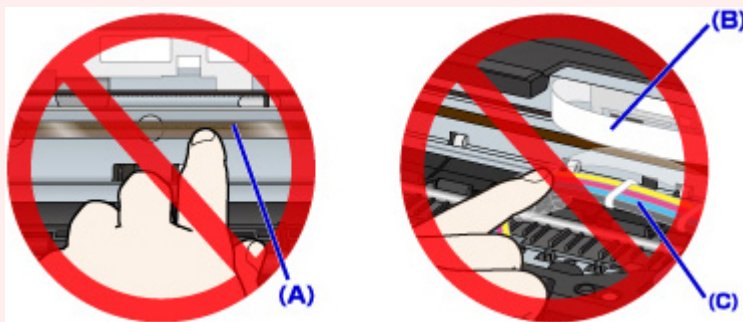

3. Check if jammed paper is under cartridge holder.

If the jammed paper is under the cartridge holder, move the cartridge holder to the far right or left, whichever makes it easier to remove the paper.

When moving the cartridge holder, hold the top of the cartridge holder and slide it slowly to the far right or left.

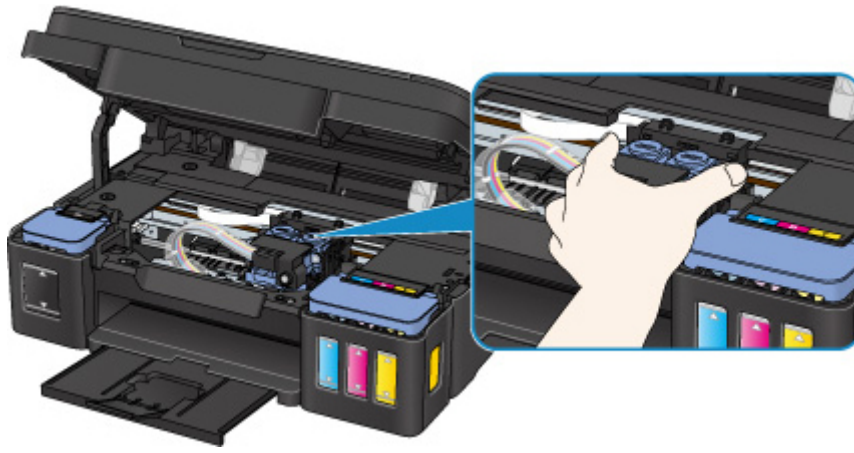

4. Hold jammed paper firmly in both hands.

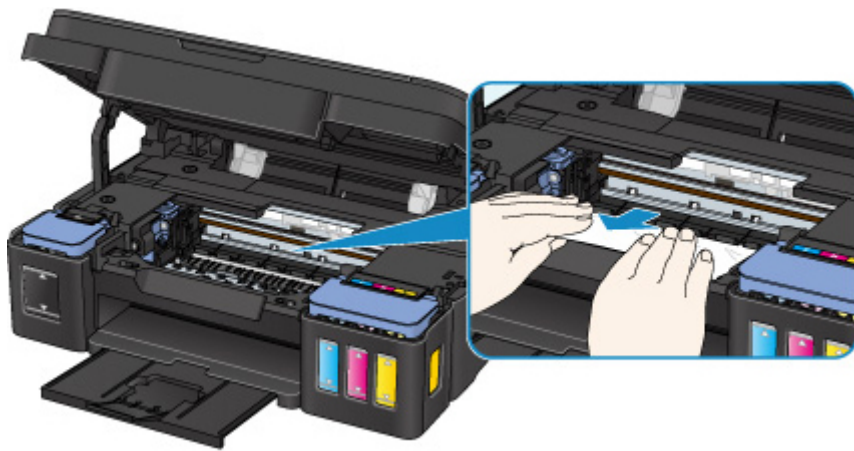

If the paper is rolled up, pull out it.

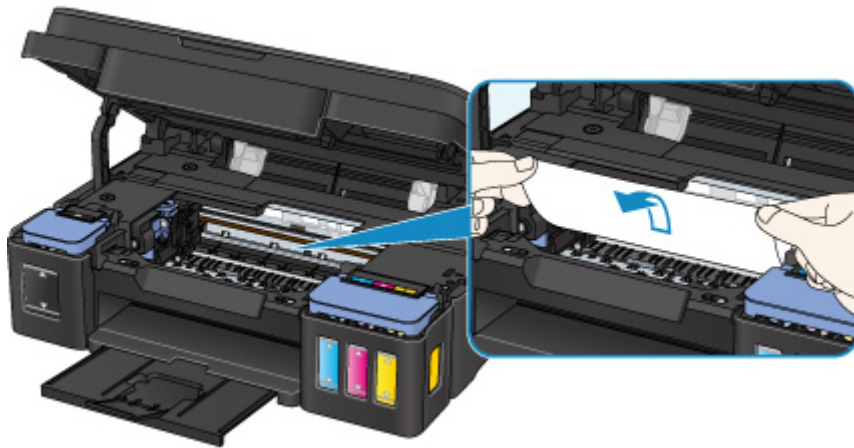

5. Slowly pull out paper, so as not to tear it.

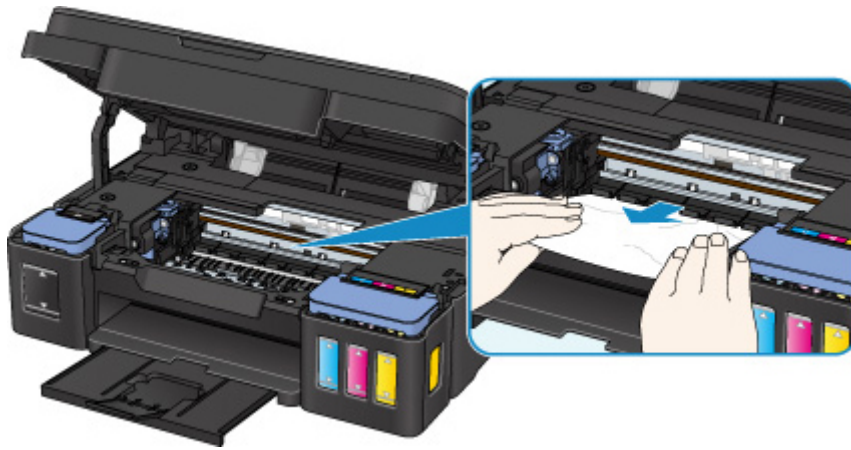

6. Make sure all jammed paper is removed.

If the paper tears when you pull out it, a bit of paper may remain in the machine. Check the following and remove any remaining paper.

- Any paper left under the cartridge holder?
- Any small bits of paper left in the machine?
- Any paper left in the left and right empty spaces (D) in the machine?

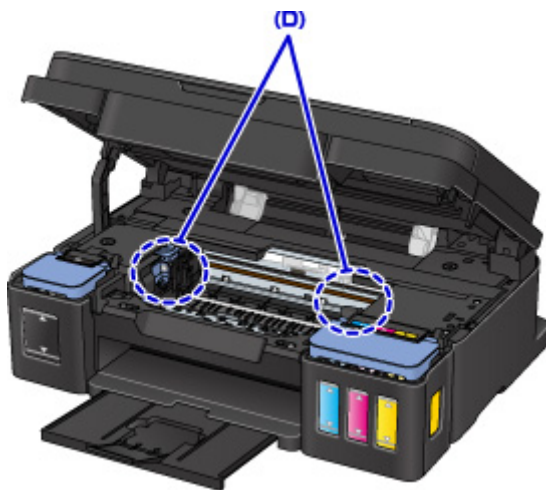

7. Close scanning unit / cover.

All jobs in the print queue are canceled. Redo the printing.

▶▶ Note

- When reloading the paper, make sure you are using suitable paper and loading it correctly. If a paper jam message appears on your computer screen when you resume printing after removing all the jammed paper, there may be some paper still inside the machine. Check the machine again for any remaining bits of paper.

If the measures above do not solve the problem, contact your nearest Canon service center to request a repair.

»» Important

- Do not tilt the machine when moving it since the ink may leak out.
- When transporting the machine for repairing it, see [Repairing Your Machine](#).

Other Cases

Check the following:

Check1 Is anything blocking paper output slot?

Check2 Are there any foreign objects in rear tray?



If there are any foreign objects in the rear tray, be sure to turn off the machine, unplug it, and then remove the foreign object.



▶▶ Important

- Do not tilt the machine or do not it upside down. Doing so may cause the ink to leak.

Check3 Is paper curled?

Correct curl before loading paper.

1000

Cause

Possible causes include the following.

- There is no paper in the rear tray.
- Paper is not loaded properly.

What to Do

Take the corresponding actions below.

- Load paper in the rear tray.
- Align the paper guides with the both edges of the paper when you load paper.

After carrying out the above measures, press the machine's **Black** or **Color** button.

1200

Cause

Scanning unit/cover is open.

What to Do

Close the scanning unit / cover and wait for a while.

Do not close it while you are refilling an ink tank.

1403

Cause

Print head may be damaged.

What to Do

Contact your nearest Canon service center to request a repair.

►► Important

- Do not tilt the machine when moving it since the ink may leak out.
- When transporting the machine for repairing it, see [Repairing Your Machine](#).

1470

Cause

Cartridge is not installed properly.

What to Do

Open the scanning unit / cover, and then push the cartridge locking cover to make sure the cartridges are installed properly.

Alternatively, push the joint button.

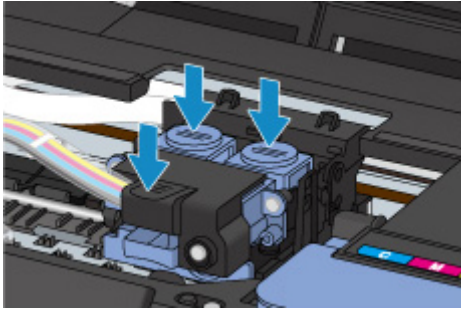

►► Important

- Remove the label and the protective tape of the cartridge to install it.

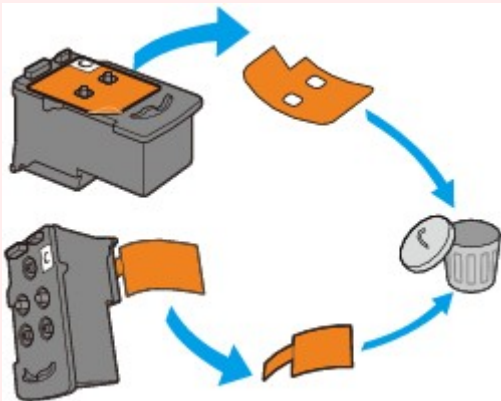

After that, close the scanning unit / cover.

1471

Cause

Cartridge cannot be recognized.

What to Do

Printing cannot be executed because the cartridge may not be installed properly or may not be compatible with this machine.

Install the appropriate cartridge.

If you want to cancel printing, press the machine's **Stop** button.

1472

Cause

Cartridge cannot be recognized.

What to Do

Printing cannot be executed because the cartridge may not be installed properly or may not be compatible with this machine.

Install the appropriate cartridge.

If you want to cancel printing, press the machine's **Stop** button.

1473

Cause

Cartridge cannot be recognized.

What to Do

Printing cannot be executed because the cartridge may not be installed properly or may not be compatible with this machine.

Install the appropriate cartridge.

If you want to cancel printing, press the machine's **Stop** button.

1474

Cause

Cartridge is not installed in correct position.

What to Do

Make sure each cartridge is installed in the correct position.

If printing is in progress, press the machine's **Stop** button to cancel printing, and then install the cartridge.

1475

Cause

More than one cartridge of the same color is installed.

What to Do

Install the cartridge in the correct position.

1476

Cause

Appropriate cartridge is not installed.

What to Do

Printing cannot be executed because the cartridge is not compatible with this machine.

Install the appropriate cartridge.

If you want to cancel printing, press the machine's **Stop** button.

1640

Cause

The 1640 support code signifies that the printer has detected that the remaining ink in one or more of the ink tanks may have reached the lower limit line shown on the ink tank.

What to Do

To check the remaining ink level, visually inspect the remaining ink in the ink tank. The action you should take to resume operating the printer depends upon which function(s) of the printer you intend to use.

1. To PRINT or COPY

If you intend to PRINT or COPY, you should take one of the following steps:

(a) Press the **Start** button on the printer. If there is some residual amount of ink in the tank(s), you will be able to PRINT or COPY until the remaining ink is depleted, although image quality may diminish as the remaining ink in the tank(s) becomes depleted.

Please note that if you continue to PRINT or COPY when the remaining ink is below the lower limit line, the printer may consume excess ink as it attempts to return to normal image quality after it is refilled with ink.

Once you press the **Start** button, the function for notifying you of the remaining ink level will not operate. To restore that function, refill the ink tank(s) up to the upper limit line shown on the ink tank(s), and then press the **Start** button for at least five seconds, and then release it.

OR

(b) Refill the ink tank with the corresponding color of ink up to the upper limit line shown on the ink tank.

■ [Refilling Ink Tanks](#)

You will then be able to PRINT or COPY.

2. To SCAN or FAX

If you intend to SCAN (or FAX if your printer has that capability), you should take one of the following steps:

(a) Press the **Start** button on the printer. You will then be able to SCAN (or FAX if your printer has that capability). After you press the **Start** button, the function for notifying you of the remaining ink level will not operate. To restore that function, refill the ink tank(s) up to the upper limit line shown on the ink tank(s), and then press the **Start** button for at least five seconds, and then release it.

OR

(b) Refill the ink tank with the corresponding color of ink up to the upper limit line shown on the ink tank.

■ [Refilling Ink Tanks](#)

1700

Cause

Ink absorber is almost full.

What to Do

Press the machine's **Black** or **Color** button to continue printing. Contact your nearest Canon service center to request a repair.

▶▶ Important

- Do not tilt the machine when moving it since the ink may leak out.
- When transporting the machine for repairing it, see [Repairing Your Machine](#).

1701

Cause

Ink absorber is almost full.

What to Do

Press the machine's **Black** or **Color** button to continue printing. Contact your nearest Canon service center to request a repair.

▶▶ Important

- Do not tilt the machine when moving it since the ink may leak out.
- When transporting the machine for repairing it, see [Repairing Your Machine](#).

1890

Cause

Protective material or tape may still be attached to cartridge holder.

What to Do

Open the scanning unit / cover and make sure the protective material and tape have been removed from the cartridge holder.

If the protective material or tape is still there, remove it and close the scanning unit / cover.

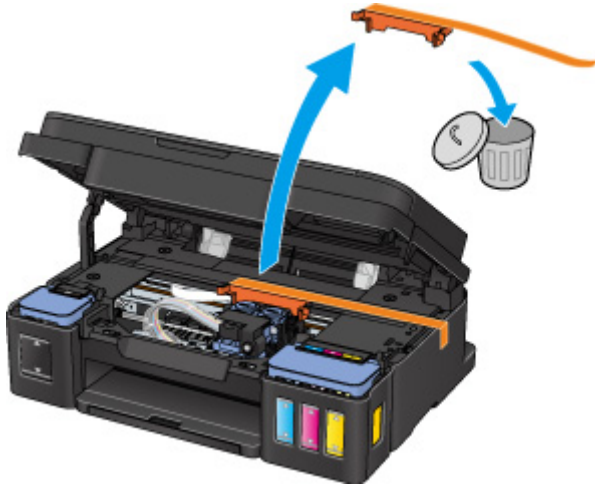

If this does not solve the problem, contact your nearest Canon service center to request a repair.

►► Important

- Do not tilt the machine when moving it since the ink may leak out.
- When transporting the machine for repairing it, see [Repairing Your Machine](#).

2900

Cause

Scanning print head alignment sheet failed.

What to Do

Press the machine's **Black** or **Color** button. Check the following points, perform automatic print head alignment again.

- Make sure the print head alignment sheet is set in the correct position and orientation on the platen glass.
- Make sure the platen glass and the print head alignment sheet are not dirty.
- Make sure the loaded paper is correct.

For automatic print head alignment, load A4 or Letter-sized plain paper.

- Make sure the print head nozzle is not clogged.

Check the print head condition by printing the nozzle check pattern.

If the error is not resolved, perform manual print head alignment.

2901



Cause

Print head alignment pattern has been printed and machine is waiting to scan sheet.

What to Do

Scan the printed alignment pattern.

1. Load print head alignment sheet on platen glass.

Place the printed side down and align the mark  in the upper left corner of the sheet with the alignment mark .



2. Slowly close the document cover and press machine's **Black** or **Color** button.

The machine starts scanning the print head alignment sheet, and automatically adjusts the print head position.

5011

Cause

Printer error has occurred.

What to Do

Turn off the machine and unplug it.

Plug in the machine again and turn it back on.

If this does not solve the problem, contact your nearest Canon service center to request a repair.

▶▶ Important

- Do not tilt the machine when moving it since the ink may leak out.
- When transporting the machine for repairing it, see [Repairing Your Machine](#).

5012

Cause

Printer error has occurred.

What to Do

Turn off the machine and unplug it.

Plug in the machine again and turn it back on.

If this does not solve the problem, contact your nearest Canon service center to request a repair.

▶▶ Important

- Do not tilt the machine when moving it since the ink may leak out.
- When transporting the machine for repairing it, see [Repairing Your Machine](#).

5050

Cause

Printer error has occurred.

What to Do

Turn off the machine and unplug it.

Plug in the machine again and turn it back on.

If this does not solve the problem, contact your nearest Canon service center to request a repair.

▶▶ Important

- Do not tilt the machine when moving it since the ink may leak out.
- When transporting the machine for repairing it, see [Repairing Your Machine](#).

5100

Cause

Printer error has occurred.

What to Do

Cancel printing and turn off the machine.

Check the following:

- Make sure cartridge holder motion is not impeded by stabilizer, jammed paper, etc.
Remove any impediment.
- Make sure the cartridges are properly installed.

Turn the machine back on.

If this does not solve the problem, contact your nearest Canon service center to request a repair.

▶▶ Important

- When clearing an impediment to cartridge holder motion, be careful not to touch clear film (A), white belt (B), or tubes (C).

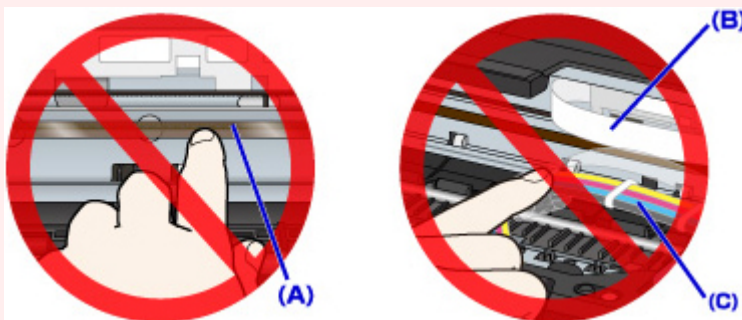

- Do not tilt the machine when moving it since the ink may leak out.
- When transporting the machine for repairing it, see [Repairing Your Machine](#).

5200

Cause

Printer error has occurred.

What to Do

Check the remaining ink level, and then refill the ink tank if necessary.

Turn off the machine and unplug it.

Wait about 10 minutes.

Plug in the machine again and turn it back on.

If the ink tank is refilled because it runs out of ink, perform system cleaning.

- From computer:

- For Windows:

■ [Cleaning the Print Heads](#)

- For Mac OS:

■ [Cleaning the Print Heads](#)

- From operation panel:

To perform system cleaning, press and hold the **Stop** button until the **Alarm** lamp flashes 5 times, and then release the button.

►► Important

- Before performing system cleaning, check the remaining ink level of all colors. If the remaining ink level is below the single dot (a), refill the ink tank of corresponding color. Performing system cleaning when the remaining ink level is not enough may damage the machine.



If this does not solve the problem, contact your nearest Canon service center to request a repair.

►► Important

- Do not tilt the machine when moving it since the ink may leak out.
- When transporting the machine for repairing it, see [Repairing Your Machine](#).

5400

Cause

Printer error has occurred.

What to Do

Turn off the machine and unplug it.

Plug in the machine again and turn it back on.

If this does not solve the problem, contact your nearest Canon service center to request a repair.

▶▶ Important

- Do not tilt the machine when moving it since the ink may leak out.
- When transporting the machine for repairing it, see [Repairing Your Machine](#).

5700

Cause

Printer error has occurred.

What to Do

Turn off the machine and unplug it.

Plug in the machine again and turn it back on.

If this does not solve the problem, contact your nearest Canon service center to request a repair.

▶▶ Important

- Do not tilt the machine when moving it since the ink may leak out.
- When transporting the machine for repairing it, see [Repairing Your Machine](#).

5B00

Cause

Printer error has occurred.

What to Do

Contact your nearest Canon service center to request a repair.

►► Important

- Do not tilt the machine when moving it since the ink may leak out.
- When transporting the machine for repairing it, see [Repairing Your Machine](#).

5B01

Cause

Printer error has occurred.

What to Do

Contact your nearest Canon service center to request a repair.

▶▶ Important

- Do not tilt the machine when moving it since the ink may leak out.
- When transporting the machine for repairing it, see [Repairing Your Machine](#).

6000

Cause

Printer error has occurred.

What to Do

Turn off the machine and unplug it.

Plug in the machine again and turn it back on.

If this does not solve the problem, contact your nearest Canon service center to request a repair.

Important

- Do not tilt the machine when moving it since the ink may leak out.
- When transporting the machine for repairing it, see [Repairing Your Machine](#).

6800

Cause

Printer error has occurred.

What to Do

Turn off the machine and unplug it.

Plug in the machine again and turn it back on.

If this does not solve the problem, contact your nearest Canon service center to request a repair.

▶▶ Important

- Do not tilt the machine when moving it since the ink may leak out.
- When transporting the machine for repairing it, see [Repairing Your Machine](#).

6801

Cause

Printer error has occurred.

What to Do

Turn off the machine and unplug it.

Plug in the machine again and turn it back on.

If this does not solve the problem, contact your nearest Canon service center to request a repair.

▶▶ Important

- Do not tilt the machine when moving it since the ink may leak out.
- When transporting the machine for repairing it, see [Repairing Your Machine](#).

6930

Cause

Printer error has occurred.

What to Do

Turn off the machine and unplug it.

Plug in the machine again and turn it back on.

If this does not solve the problem, contact your nearest Canon service center to request a repair.

▶▶ Important

- Do not tilt the machine when moving it since the ink may leak out.
- When transporting the machine for repairing it, see [Repairing Your Machine](#).

6931

Cause

Printer error has occurred.

What to Do

Turn off the machine and unplug it.

Plug in the machine again and turn it back on.

If this does not solve the problem, contact your nearest Canon service center to request a repair.

▶▶ Important

- Do not tilt the machine when moving it since the ink may leak out.
- When transporting the machine for repairing it, see [Repairing Your Machine](#).

6932

Cause

Printer error has occurred.

What to Do

Turn off the machine and unplug it.

Plug in the machine again and turn it back on.

If this does not solve the problem, contact your nearest Canon service center to request a repair.

▶▶ Important

- Do not tilt the machine when moving it since the ink may leak out.
- When transporting the machine for repairing it, see [Repairing Your Machine](#).

6933

Cause

Printer error has occurred.

What to Do

Turn off the machine and unplug it.

Plug in the machine again and turn it back on.

If this does not solve the problem, contact your nearest Canon service center to request a repair.

▶▶ Important

- Do not tilt the machine when moving it since the ink may leak out.
- When transporting the machine for repairing it, see [Repairing Your Machine](#).

6936

Cause

Printer error has occurred.

What to Do

Turn off the machine and unplug it.

Plug in the machine again and turn it back on.

If this does not solve the problem, contact your nearest Canon service center to request a repair.

▶▶ Important

- Do not tilt the machine when moving it since the ink may leak out.
- When transporting the machine for repairing it, see [Repairing Your Machine](#).

6937

Cause

Printer error has occurred.

What to Do

Turn off the machine and unplug it.

Plug in the machine again and turn it back on.

If this does not solve the problem, contact your nearest Canon service center to request a repair.

▶▶ Important

- Do not tilt the machine when moving it since the ink may leak out.
- When transporting the machine for repairing it, see [Repairing Your Machine](#).

6938

Cause

Printer error has occurred.

What to Do

Turn off the machine and unplug it.

Plug in the machine again and turn it back on.

If this does not solve the problem, contact your nearest Canon service center to request a repair.

▶▶ Important

- Do not tilt the machine when moving it since the ink may leak out.
- When transporting the machine for repairing it, see [Repairing Your Machine](#).

6940

Cause

Printer error has occurred.

What to Do

Turn off the machine and unplug it.

Plug in the machine again and turn it back on.

If this does not solve the problem, contact your nearest Canon service center to request a repair.

▶▶ Important

- Do not tilt the machine when moving it since the ink may leak out.
- When transporting the machine for repairing it, see [Repairing Your Machine](#).

6941

Cause

Printer error has occurred.

What to Do

Turn off the machine and unplug it.

Plug in the machine again and turn it back on.

If this does not solve the problem, contact your nearest Canon service center to request a repair.

▶▶ Important

- Do not tilt the machine when moving it since the ink may leak out.
- When transporting the machine for repairing it, see [Repairing Your Machine](#).

6942

Cause

Printer error has occurred.

What to Do

Turn off the machine and unplug it.

Plug in the machine again and turn it back on.

If this does not solve the problem, contact your nearest Canon service center to request a repair.

▶▶ Important

- Do not tilt the machine when moving it since the ink may leak out.
- When transporting the machine for repairing it, see [Repairing Your Machine](#).

6943

Cause

Printer error has occurred.

What to Do

Turn off the machine and unplug it.

Plug in the machine again and turn it back on.

If this does not solve the problem, contact your nearest Canon service center to request a repair.

▶▶ Important

- Do not tilt the machine when moving it since the ink may leak out.
- When transporting the machine for repairing it, see [Repairing Your Machine](#).

6944

Cause

Printer error has occurred.

What to Do

Turn off the machine and unplug it.

Plug in the machine again and turn it back on.

If this does not solve the problem, contact your nearest Canon service center to request a repair.

▶▶ Important

- Do not tilt the machine when moving it since the ink may leak out.
- When transporting the machine for repairing it, see [Repairing Your Machine](#).

6945

Cause

Printer error has occurred.

What to Do

Turn off the machine and unplug it.

Plug in the machine again and turn it back on.

If this does not solve the problem, contact your nearest Canon service center to request a repair.

▶▶ Important

- Do not tilt the machine when moving it since the ink may leak out.
- When transporting the machine for repairing it, see [Repairing Your Machine](#).

6946

Cause

Printer error has occurred.

What to Do

Turn off the machine and unplug it.

Plug in the machine again and turn it back on.

If this does not solve the problem, contact your nearest Canon service center to request a repair.

Important

- Do not tilt the machine when moving it since the ink may leak out.
- When transporting the machine for repairing it, see [Repairing Your Machine](#).

B202

Cause

An error requiring a repair has occurred.

What to Do

Turn off the machine and unplug it.

Contact your nearest Canon service center to request a repair.

▶▶ Important

- Do not tilt the machine when moving it since the ink may leak out.
- When transporting the machine for repairing it, see [Repairing Your Machine](#).

B203

Cause

An error requiring a repair has occurred.

What to Do

Turn off the machine and unplug it.

Contact your nearest Canon service center to request a repair.

▶▶ Important

- Do not tilt the machine when moving it since the ink may leak out.
- When transporting the machine for repairing it, see [Repairing Your Machine](#).

B204

Cause

An error requiring a repair has occurred.

What to Do

Turn off the machine and unplug it.

Contact your nearest Canon service center to request a repair.

▶▶ Important

- Do not tilt the machine when moving it since the ink may leak out.
- When transporting the machine for repairing it, see [Repairing Your Machine](#).

B205

Cause

An error requiring a repair has occurred.

What to Do

Turn off the machine and unplug it.

Contact your nearest Canon service center to request a repair.

Important

- Do not tilt the machine when moving it since the ink may leak out.
- When transporting the machine for repairing it, see [Repairing Your Machine](#).