

Canon

MULTIMEDIA PROJECTOR LV-7585 User's Manual



PJLink™

Features and Design

This Multimedia Projector is designed with most advanced technology for portability, durability, and ease of use. This projector utilizes built-in multimedia features, a palette of 1.07 billion colors, and matrix liquid crystal display (LCD) technology.

◆ **Functionally Rich**

This projector has many useful functions such as lens shifting, ceiling and rear projection, perpendicular omnidirectional projection, variety of lens options, etc.

◆ **Multi-use Remote Control Unit**

Use the remote control unit as wired and wireless, or as a PC wireless mouse. Eight remote control codes and selectable pointer shapes are also available.

◆ **Simple Computer System Setting**

The projector has the Multi-scan system to conform to almost all computer output signals quickly (p.34). Up to UXGA resolution can be accepted.

◆ **Useful Functions for Presentation**

Digital zoom function allows you to focus on the crucial information during a presentation (pp.14, 40).

◆ **Security Function**

The Security function helps you to ensure security of the projector. With the Key lock function, you can lock the operation on the side control or remote control unit (p.53). PIN code lock functions prevents unauthorized use of the projector (pp.53–54).

◆ **Lamp Mode**

Brightness of the projection lamp can be selected (p.51).

◆ **Automatic Filter Replacement Function**

The projector monitors the condition of the filter and replaces a filter automatically when it detects the clogging.

◆ **Power Management**

The Power management function reduces power consumption and maintains lamp life (p.52).

◆ **Multilanguage Menu Display**

Operation menu is available in 12 languages; English, German, French, Italian, Spanish, Portuguese, Dutch, Swedish, Russian, Chinese, Korean, and Japanese (p.48).

◆ **Network-capable**

Through an optional Network Imager, you can operate and control the projector.

◆ **Logo Function**

The Logo function allows you to customize the screen logo (pp.49–50). You can capture an image for the screen logo and use it for the starting-up display or between presentations.

◆ **Pointer Function**

Remote control pointer function. This function helps you to make a smart presentation on a projected screen.

◆ **Helpful Maintenance Functions**

Lamp and filter maintenance functions provide for better and proper maintenance of the projector.

◆ **Multiple Interface Terminals**

The projector has several interface terminals that can support various types of equipment and signals (p.11).

◆ **Motor-driven Lens Shift**

Projection lens can be moved up, down, right and left with the motor-driven lens shift function. This function makes it easy to provide projected image where you want. Zoom and focus can also be adjusted with a motor-driven operation. (p.27)

✓ **Note:**

- The On-Screen Menu and figures in this manual may differ slightly from the product.
- The contents of this manual are subject to change without notice.

Table of Contents

Features and Design	2	Computer Input	34
Table of Contents	3	Computer System Selection	34
To The Owner	4	Auto PC Adjustment	35
Safety Instructions	5	Manual PC Adjustment	36
Air Circulation	6	Image Level Selection	38
Installing the Projector in Proper Directions	7	Screen Size Adjustment	39
Moving the Projector	8	Video Input	41
Cautions in Handling the Projector	8	Video System Selection	41
Compliance	9	Image Level Selection	42
Part Names and Functions	10	Screen Size Adjustment	43
Front	10	Picture Image	45
Back	10	Image Adjustment	45
Bottom	10	Setting	48
Rear Terminal	11	Setting	48
Side Control and Indicators	12	Maintenance and Care	56
Remote Control Unit	13	Filter Instructions	56
Remote Control Battery Installation	15	Replacing the Filter Cartridge	57
Remote Control Receivers and Operating Range	15	Resetting the Filter Counter	58
Wired Remote Control Transmitter	15	Resetting the Scroll Counter	58
Remote Control Code	16	Lamp Replacement	59
Installation	17	Resetting the Lamp Counter	60
Positioning the Projector	17	Cleaning the Projection Lens	62
Adjustable Feet	17	Cleaning the Projector Cabinet	62
Lens Installation	18	Warning Indicators	63
Connecting to a Computer (Digital and Analog RGB)	20	Appendix	64
Connecting to Video Equipment (Video, S-Video)	21	Troubleshooting	64
Connecting the AC Power Cord	22	Menu Tree	66
Basic Operation	23	Indicators and Projector Condition	69
Turning On the Projector	23	Compatible Computer Specifications	71
Turning Off the Projector	24	Technical Specifications	73
How to Operate the On-Screen Menu	25	Optional Parts	74
Menu Bar	26	Lens Replacement	74
Operating with Projector Control	27	PJ Link Notice	74
Operating with Remote Control Unit	28	Configurations of Terminals	75
Pointer Function	30	Dimensions	77
Wireless Mouse Operation	30	Serial Control Interface	78
Input Selection	31		
Input	31		
Computer Input Source Selection	32		
Video Input Source Selection	33		

Trademarks

Each name of corporations or products in this book is either a registered trademark or a trademark of its respective corporation.





To The Owner

Before installing and operating the projector, read this manual thoroughly.

The projector provides many convenient features and functions. Operating the projector properly enables you to manage those features and maintains it in good condition for many years to come.

Improper operation may result in not only shortening the product life, but also malfunctions, fire hazard, or other accidents.

If your projector seems to operate improperly, read this manual again, check operations and cable connections and try the solutions in the "Troubleshooting" section in the back of this booklet. If the problem still persists, contact the dealer where you purchased the projector or the service center.

	CAUTION RISK OF ELECTRIC SHOCK DO NOT OPEN	
CAUTION: TO REDUCE THE RISK OF ELECTRIC SHOCK, DO NOT REMOVE COVER (OR BACK). NO USER-SERVICEABLE PARTS INSIDE EXCEPT LAMP REPLACEMENT. REFER SERVICING TO QUALIFIED SERVICE PERSONNEL.		
	THIS SYMBOL INDICATES THAT DANGEROUS VOLTAGE CONSTITUTING A RISK OF ELECTRIC SHOCK IS PRESENT WITHIN THIS UNIT.	
	THIS SYMBOL INDICATES THAT THERE ARE IMPORTANT OPERATING AND MAINTENANCE INSTRUCTIONS IN THE USER'S MANUAL WITH THIS UNIT.	

CAUTION

Not for use in a computer room as defined in the Standard for the Protection of Electronic Computer/Data Processing Equipment, ANSI/NFPA 75.

NOTE FOR CUSTOMERS IN THE US

(Hg) LAMP(S) INSIDE THIS PRODUCT CONTAIN MERCURY AND MUST BE RECYCLED OR DISPOSED OF ACCORDING TO LOCAL, STATE OR FEDERAL LAWS.



Safety Precaution

WARNING: TO REDUCE THE RISK OF FIRE OR ELECTRIC SHOCK, DO NOT EXPOSE THIS APPLIANCE TO RAIN OR MOISTURE.

- This projector produces intense light from the projection lens. Do not stare directly into the lens, otherwise eye damage could result. Be especially careful that children do not stare directly into the beam.
- Install the projector in a proper position. Otherwise it may result in a fire hazard.
- Allowing the proper amount of space on the top, sides, and rear of the projector cabinet is critical for proper air circulation and cooling of the unit. The diagrams shown here indicate the minimum space required. If the projector is to be built into a compartment or similarly enclosed, these minimum distances must be maintained.
- Do not cover the ventilation slots on the projector. Heat build-up can reduce the service life of your projector, and can also be dangerous.

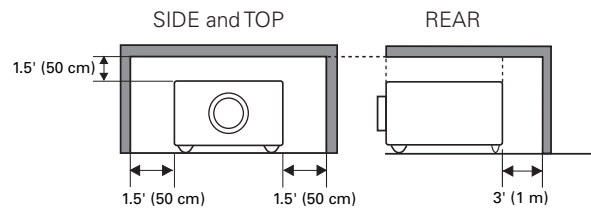

- If the projector is unused for an extended time, unplug the projector from the power outlet.



CAUTION ON HANGING FROM THE CEILING

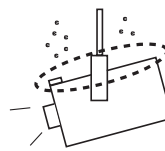

When hanging the projector from the ceiling, clean the air intake vents and top of the projector periodically with a vacuum cleaner. If you leave the projector unclean for a long time, the cooling fans can be clogged with dust, and it may cause a breakdown or a disaster.

DO NOT SET THE PROJECTOR IN GREASY, WET, OR SMOKY CONDITIONS SUCH AS IN A KITCHEN TO PREVENT A BREAKDOWN OR A DISASTER. IF THE PROJECTOR COMES IN CONTACT WITH OIL OR CHEMICALS, IT MAY BECOME DETERIORATED.

READ AND KEEP THIS USER'S MANUAL FOR LATER USE.

Safety Instructions

All the safety and operating instructions should be read before the product is operated.

Read all of the instructions given here and retain them for later use. Unplug this projector from AC power supply before cleaning. Do not use liquid or aerosol cleaners. Use a damp cloth for cleaning.

Follow all warnings and instructions marked on the projector.

For added protection to the projector during a lightning storm, or when it is left unattended and unused for long periods of time, unplug it from the wall outlet. This will prevent damage due to lightning and power line surges.

Do not expose this unit to rain or use near water... for example, in a wet basement, near a swimming pool, etc...

Do not use attachments not recommended by the manufacturer as they may cause hazards.

Do not place this projector on an unstable cart, stand, or table. The projector may fall, causing serious injury to a child or adult, and serious damage to the projector. Use only with a cart or stand recommended by the manufacturer, or sold with the projector. Wall or shelf mounting should follow the manufacturer's instructions, and should use a mounting kit approved by the manufacturers.

An appliance and cart combination should be moved with care. Quick stops, excessive force, and uneven surfaces may cause the appliance and cart combination to overturn.



Slots and openings in the back and bottom of the cabinet are provided for ventilation, to ensure reliable operation of the equipment and to protect it from overheating.

The openings should never be covered with cloth or other materials, and the bottom opening should not be blocked by placing the projector on a bed, sofa, rug, or other similar surface. This projector should never be placed near or over a radiator or heat register.

This projector should not be placed in a built-in installation such as a book case unless proper ventilation is provided.

Never push objects of any kind into this projector through cabinet slots as they may touch dangerous voltage points or short out parts that could result in a fire or electric shock. Never spill liquid of any kind on the projector.

Do not install the projector near the ventilation duct of air-conditioning equipment.

This projector should be operated only from the type of power source indicated on the marking label. If you are not sure of the type of power supplied, consult your authorized dealer or local power company.

Do not overload wall outlets and extension cords as this can result in fire or electric shock. Do not allow anything to rest on the power cord. Do not locate this projector where the cord may be damaged by persons walking on it.

Do not attempt to service this projector yourself as opening or removing covers may expose you to dangerous voltage or other hazards. Refer all servicing to qualified service personnel.

Unplug this projector from wall outlet and refer servicing to qualified service personnel under the following conditions:

- a. When the power cord or plug is damaged or frayed.
- b. If liquid has been spilled into the projector.
- c. If the projector has been exposed to rain or water.
- d. If the projector does not operate normally by following the operating instructions. Adjust only those controls that are covered by the operating instructions as improper adjustment of other controls may result in damage and will often require extensive work by a qualified technician to restore the projector to normal operation.
- e. If the projector has been dropped or the cabinet has been damaged.
- f. When the projector exhibits a distinct change in performance-this indicates a need for service.

When replacement parts are required, be sure the service technician has used replacement parts specified by the manufacturer that have the same characteristics as the original part. Unauthorized substitutions may result in fire, electric shock, or injury to persons.

Upon completion of any service or repairs to this projector, ask the service technician to perform routine safety checks to determine that the projector is in safe operating condition.

Safety Instructions

Air Circulation

Openings in the cabinet are provided for ventilation. To ensure reliable operation of the product and to protect it from overheating, these openings must not be blocked or covered.

CAUTION

Hot air is exhausted from the exhaust vent. When using or installing the projector, the following precautions should be taken.

- Do not put any flammable object or spray can near the projector, hot air is exhausted from the air vents.
- Keep the exhaust vent at least 3' (1 m) away from any objects.
- Do not touch peripheral parts of the exhaust vent, especially screws and metallic parts. These areas will become hot while the projector is being used.
- Do not put anything on the cabinet. Objects put on the cabinet will not only get damaged but also may cause fire hazard by heat.

Cooling fans are provided to cool down the projector. The fans' running speed is changed according to the temperature inside the projector.

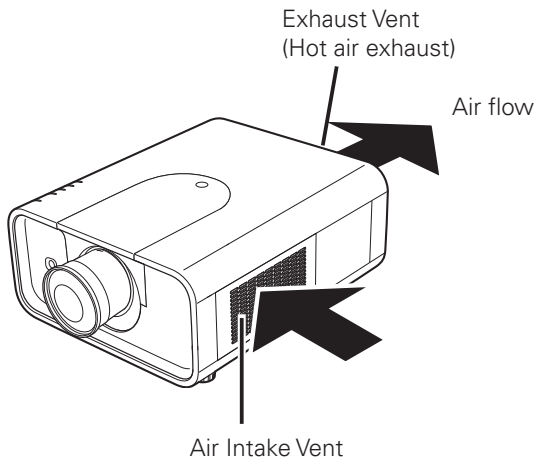

IMPORTANT!

Filter Maintenance!!

The projector uses a lamp which generates significant heat. The cooling fans and air vents are provided to dissipate the heat by drawing air into the housing and the filter is located in the intake vents to prevent dust from getting inside of the projector.

In order to care for the projector appropriately, regular cleaning is required. Remove any dirt or dust that has accumulated on the projector.

If the projector reaches a time set in the timer setting, a Filter replacement icon (Fig. 1) appears on the screen and WARNING FILTER indicator on the top panel lights up (see below), indicating that the filter replacement is necessary.

If the projector detects that the filter is clogged and no scroll is left in the filter cartridge, a Filter cartridge replacement icon (Fig. 2) appears on the screen and WARNING FILTER indicator on the top panel lights up (see below). Stop using the projector immediately and replace the filter cartridge.

Blocking the air vents and leaving the projector uncleaned for a long time may not only damage the projector and may require costly repairs but may also cause accidents or fire.

For maintenance of the filter, refer to "Filter counter" on page 55 and "Maintenance and Care" on pages 56-58.

Damages to the projector caused by using an uncleaned filter or improper maintenance will void the warranty on the projector.

Top Panel

LAMP  

LAMP REPLACE  

WARNING FILTER  

WARNING TEMP.  

WARNING FILTER indicator



Fig.1 Filter replacement icon



Fig.2 Filter cartridge replacement icon

Installing the Projector in Proper Directions

Use the projector properly in specified positions. Improper positioning may reduce the lamp life and result in severe accident or fire hazard.

This projector can project the picture in upward, downward, or inclined position in perpendicular direction to the horizontal plane. When installing the projector in downwardly inclined position, install the projector bottom side up.

✓ Note:

- When the image is top/bottom and left/right reversed, set the ceiling function to "On." (pp. 40, 44)

Positioning Precautions

Avoid positioning the projector as described below when installing.

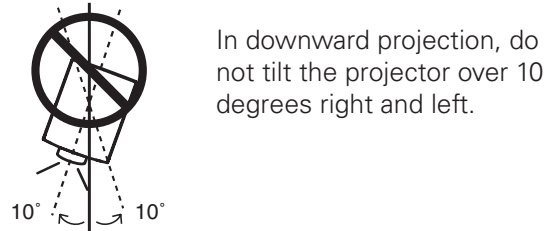
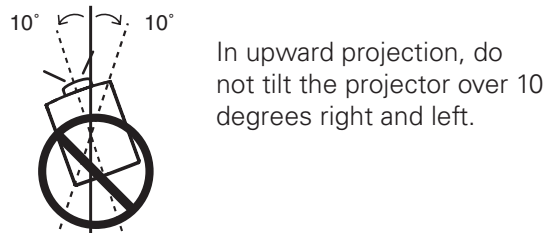
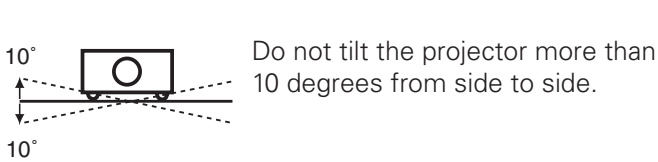

CAUTION ON CEILING MOUNTING

For ceiling mounting, you need the ceiling mount kit designed for this projector. When not mounted properly, the projector may fall, causing hazards or injury. For details, consult your dealer. The warranty on this projector does not cover any damage caused by use of any non-recommended ceiling mount kit or installation of the ceiling mount kit in an improper location.

Safety Instructions

Moving the Projector

Use the handle grip when moving the projector.

Retract the adjustable feet to prevent damage to the lens and cabinet when carrying.

When this projector is not in use for an extended period, put it into a suitable case to protect the projector.

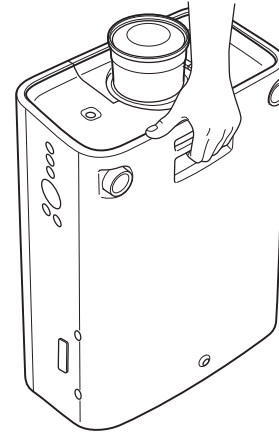

CAUTION IN CARRYING OR TRANSPORTING THE PROJECTOR

- Do not drop or bump the projector, otherwise damages or malfunctions may result.
- When carrying the projector, use a suitable carrying case.
- Do not transport the projector by courier or any other transport service in an unsuitable transport case. This may cause damage to the projector. For information about transporting the projector by courier or any other transport service, consult your dealer.
- Do not put the projector in a case before it is cooled enough.

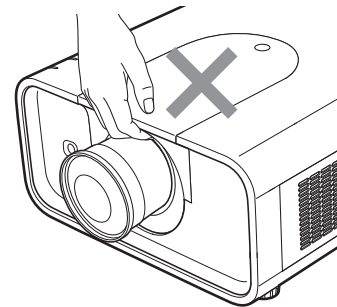

Cautions in Handling the Projector

Do not hold the lens or the top cover when lifting or moving the projector. Doing so may cause damage to the lens and the projector.

Care must be taken when handling the projector; do not drop, bump, subject it to strong forces, or put other things on the cabinet.

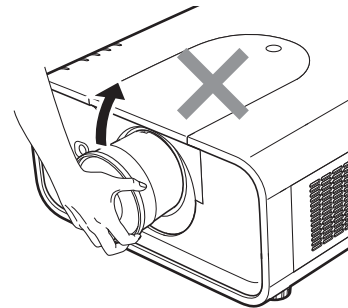

Do not hold the lens and the peripheral part.



CAUTION

This projector has a motorized lens. Please note the followings when using the projector.



- Do not touch the lens while it is moving as this could cause injury to the fingers.
- Never allow children to touch the lens.

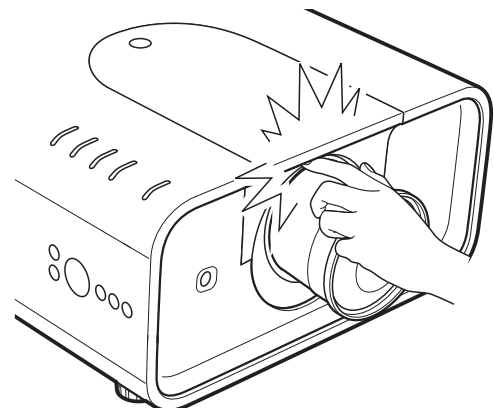

Compliance

Federal Communications Commission Notice

Multimedia Projector, Model: LV-7585

This device complies with Part 15 of the FCC Rules. Operation is subject to the following two conditions:

- (1) This device may not cause harmful interference, and
- (2) this device must accept any interference received, including interference that may cause undesired operation.

Note: This equipment has been tested and found to comply with the limits for a Class B digital device, pursuant to Part 15 of the FCC Rules. These limits are designed to provide reasonable protection against harmful interference in a residential installation. This equipment generates, uses and can radiate radio frequency energy and, if not installed and used in accordance with the instructions, may cause harmful interference to radio communications. However, there is no guarantee that interference will not occur in a particular installation. If this equipment does cause harmful interference to radio or television reception, which can be determined by turning the equipment off and on, the user is encouraged to try to correct the interference by one or more of the following measures:

- Reorient or relocate the receiving antenna.
- Increase the separation between the equipment and receiver.
- Connect the equipment into an outlet on a circuit different from that to which the receiver is connected.
- Consult the dealer or an experienced radio/TV technician for help.

Use of shielded cable is required to comply with class B limits in Subpart B of Part of FCC Rules.

Do not make any changes or modifications to the equipment unless otherwise specified in the instructions. If such changes or modifications should be made, you could be required to stop operation of the equipment.

Canon U.S.A., Inc.
One Canon Plaza, Lake Success, NY 11042-1198, U.S.A.
Tel No. (516)328-5000

Canadian Radio Interference Regulations

This Class B digital apparatus complies with Canadian ICES-003.

AC POWER CORD REQUIREMENT

The AC Power Cord supplied with this projector meets the requirement for use in the country you purchased it.

AC Power Cord for the United States and Canada:

AC Power Cord used in the United States and Canada is listed by the Underwriters Laboratories (UL) and certified by the Canadian Standard Association (CSA).

AC Power Cord has a grounding-type AC line plug. This is a safety feature to be sure that the plug will fit into the power outlet. Do not try to defeat this safety feature. Should you be unable to insert the plug into the outlet, contact your electrician.

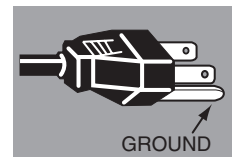

THE SOCKET-OUTLET SHOULD BE INSTALLED NEAR THE EQUIPMENT AND EASILY ACCESSIBLE.



European Union (and EEA) only.

This symbol indicates that this product is not to be disposed of with your household waste, according to the WEEE Directive (2002/96/EC) and your national law. This product should be handed over to a designated collection point, e.g., on an authorized one-for-one basis when you buy a new similar product or to an authorized collection site for recycling waste electrical and electronic equipment (EEE). Improper handling of this type of waste could have a possible negative impact on the environment and human health due to potentially hazardous substances that are generally associated with EEE. At the same time, your cooperation in the correct disposal of this product will contribute to the effective usage of natural resources. For more information about where you can drop off your waste equipment for recycling, please contact your local city office, waste authority, approved WEEE scheme or your household waste disposal service. Your cooperation in the correct disposal of this product will contribute to the effective usage of natural resources and will avoid incurring administrative sanctions according to art. 50 and following of Italian legislative decree 22/97. For more information regarding return and recycling of WEEE products, please visit www.canon-europe.com/environment.

(EEA: Norway, Iceland and Liechtenstein)

Part Names and Functions

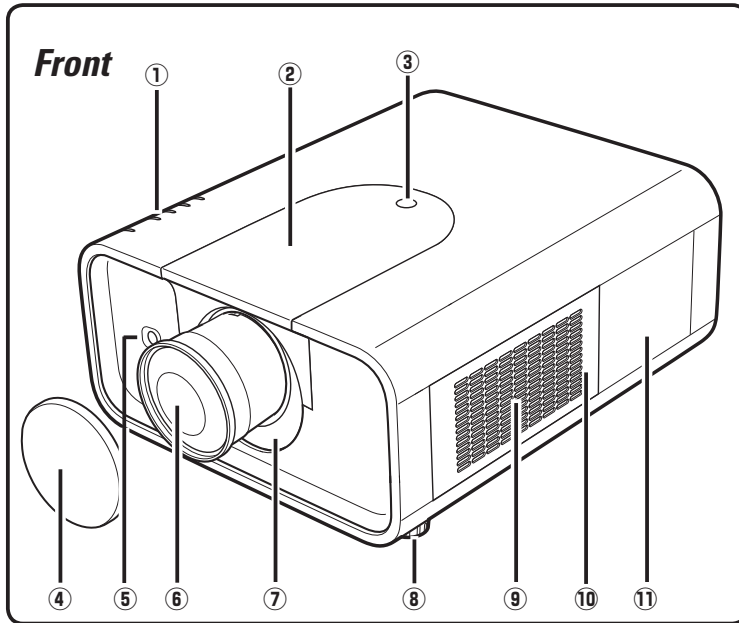

- ① Indicators
- ② Top Cover
- ③ Top Cover Release Button
- ④ Lens Cap

⚠ CAUTION

Do not turn on the projector with the lens cap attached. High temperature from light beam may damage the lens cap and result in fire hazard.

- ⑤ Infrared Remote Receiver (Front)
- ⑥ Projection Lens
- ⑦ Light-Block Sheet
- ⑧ Adjustable Feet
- ⑨ Air Intake Vent
- ⑩ Filter Cover
- ⑪ Lamp Cover
- ⑫ Exhaust Vent

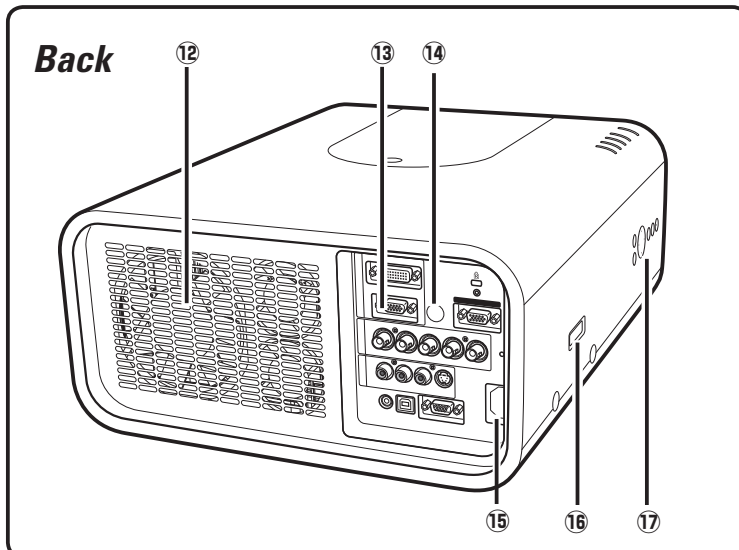

⚠ CAUTION

Hot air is exhausted from the exhaust vent. Do not put heat-sensitive objects near this side.

- ⑬ Terminals and Connectors
- ⑭ Infrared Remote Receiver (Back)
- ⑮ Power Cord Connector
- ⑯ Optional Parts Attachment
- ⑰ Side Controls
- ⑱ Hand Grip

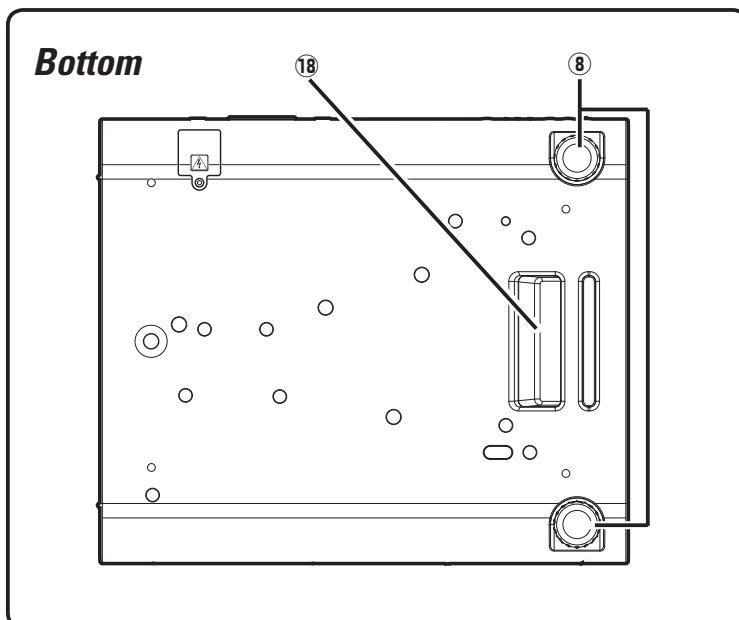

Rear Terminal

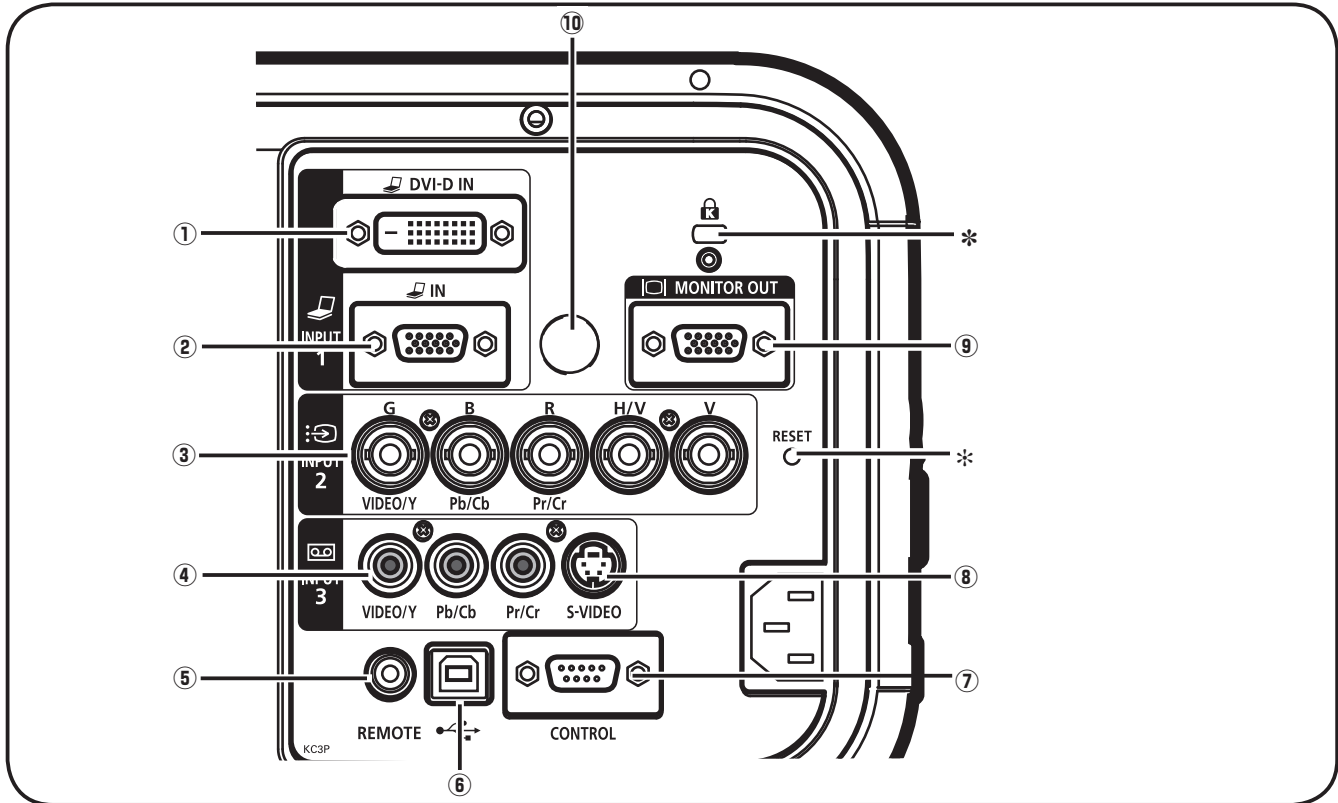

① **COMPUTER INPUT TERMINAL (DIGITAL)**

Connect the computer output digital signal to this terminal. The HDTV (HDCP compatible) signal can also be connected (pp.20-21).

✓ **Note:**

- Use a DVI-Digital cable which fits the width of the rear terminal.

② **COMPUTER INPUT TERMINAL (ANALOG)**

Connect the computer (or RGB scart) output signal to this terminal (pp.20-21).

③ **5 BNC INPUT JACKS**

Connect the component or composite video output signal from video equipment to VIDEO/Y, Pb/Cb, and Pr/Cr jacks or connect the computer output signal (5 BNC Type [Green, Blue, Red, Horiz. Sync, and Vert. Sync.]) to G, B, R, H/V, and V jacks (pp.20-21).

④ **VIDEO INPUT JACK**

Connect the component or the composite video output signal from video equipment to this jack (p.21).

⑤ **R/C JACK**

When using the wired remote control unit, connect the wired remote control unit to this jack with a remote control cable (not supplied).

⑥ **USB CONNECTOR (Series B)**

Use this connector when controlling a computer with the remote control unit of the projector. Connect the USB terminal of your computer to this connector with the supplied USB cable (p.20).

⑦ **CONTROL PORT CONNECTOR**

When controlling the projector from a computer, connect the computer to this connector with a control cable (p.20).

⑧ **S-VIDEO INPUT JACK**

Connect the S-VIDEO output signal from video equipment to this jack (p.21).

⑨ **MONITOR OUT TERMINAL**

This terminal can be used to output the incoming analog RGB signal from INPUT 1-3 terminal to the other monitor (pp.20-21).

⑩ **INFRARED REMOTE RECEIVER (Back)**

The infrared remote receiver is also located in the front (pp.10, 15).

* **Kensington Security Slot**

This slot is for a Kensington lock used to deter theft of the projector.

*Kensington is a registered trademark of ACCO Brands Corporation.

* **RESET button**

A built-in micro processor which controls this unit may occasionally malfunction and need to be reset. This can be done by pressing the RESET button with a pen, which will shut down and restart the unit. Do not use the RESET function excessively.

Side Control and Indicators

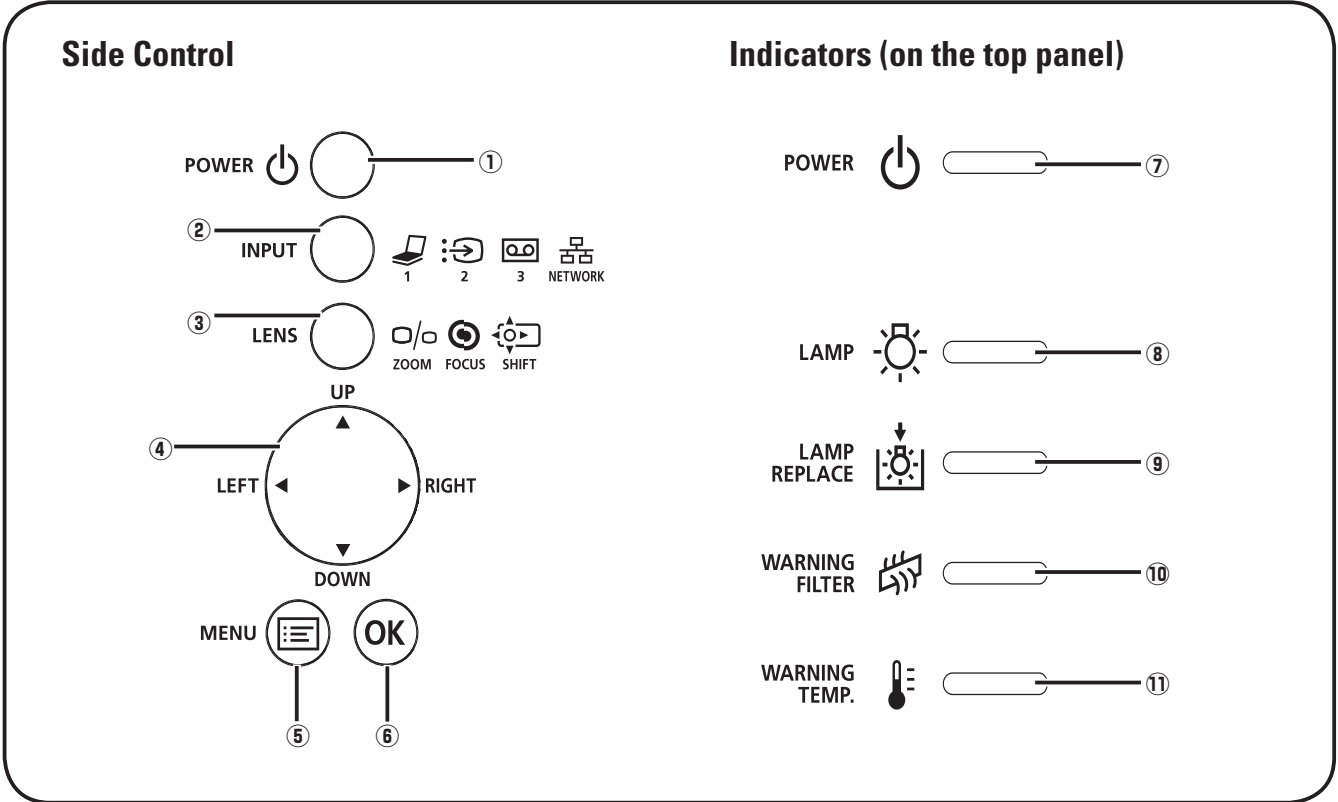

① POWER button

Turn the projector on or off (pp.23–24).

② INPUT button

Select an input source (pp.31–33).

③ LENS button

Enter the focus, zoom, and lens shift adjustment mode (p.27).

④ Point ▲▼◀▶ buttons

- Select an item or adjust the value in the On-Screen Menu (p.25).
- Pan the image in Digital zoom + mode (p.40).

⑤ MENU button

Open or close the On-Screen Menu (p.25).

⑥ OK button

- Execute the selected item (p.25).
- Expand or compress the image in the Digital zoom mode (p.40).

⑦ POWER indicator

- Light when in stand-by mode and during operations.
- Blink in the Power management mode (p.52).

⑧ LAMP indicator

Light red during operations.

⑨ LAMP REPLACE indicator

Light orange when the projection lamp reaches its end of life (pp.59, 70).

⑩ WARNING FILTER indicator

- Blink slow when the filter is being scrolled (pp. 56, 69).
- Blink fast when the filter scroll is not working properly or the filter cartridge is not installed (p.56, 70).
- Light orange when the clogging of the filter is detected or the filter counter reaches a time set in the timer setting, urging immediate filter/ filter cartridge replacement (p.55, 56 70).

⑪ WARNING TEMP. indicator

Blink red when the internal temperature of the projector exceeds the operating range (pp.63, 69-70).

Remote Control Unit

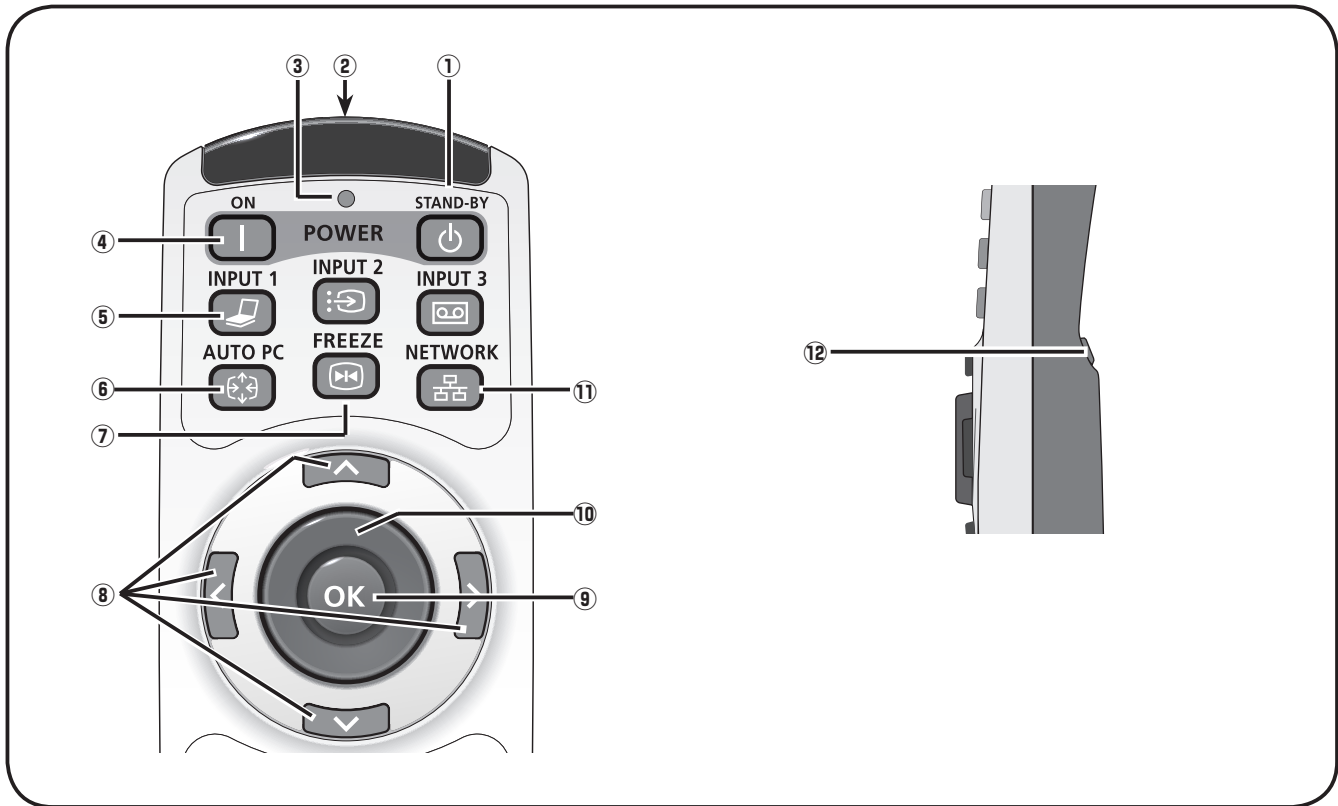

- ① **STAND-BY button**
Turn the projector off (p.24).
- ② **WIRED REMOTE jack**
Connect the remote control cable (not supplied) to this jack when using as a wired remote control unit.
- ③ **SIGNAL EMISSION indicator**
Light red while a signal is being sent from the remote control unit to the projector.
- ④ **ON button**
Turn the projector on (p.23).
- ⑤ **INPUT 1 – 3 buttons**
Select an input source (INPUT 1 – INPUT 3) (pp.31–33).
- ⑥ **AUTO PC button**
Automatically adjust the computer image to its optimum setting (pp.28, 35).
- ⑦ **FREEZE button**
Freeze the picture on the screen (p.28).
- ⑧ **POINT ▲▼◀▶ buttons**
 - Select an item or adjust the value in the On-Screen Menu (p.25).
 - Pan the image in Digital zoom + mode (p.40).

- ⑨ **OK button**
 - Execute the selected item (p.25).
 - Expand or compress the image in the Digital zoom mode (p.40).
- ⑩ **MOUSE POINTER button**
Move a pointer of the projector or a pointer for wireless mouse operation (p.30).
- ⑪ **NETWORK button**
Select the Network input. (Optionally available).
- ⑫ **L-CLICK button**
Act as the left mouse button for wireless mouse operation (p.30).



To ensure safe operation, observe the following precautions:

- Do not bend, drop, or expose the remote control unit to moisture or heat.
- For cleaning, use a soft dry cloth. Do not apply benzene, thinner, splay, or any other chemical materials.

Remote Control Unit

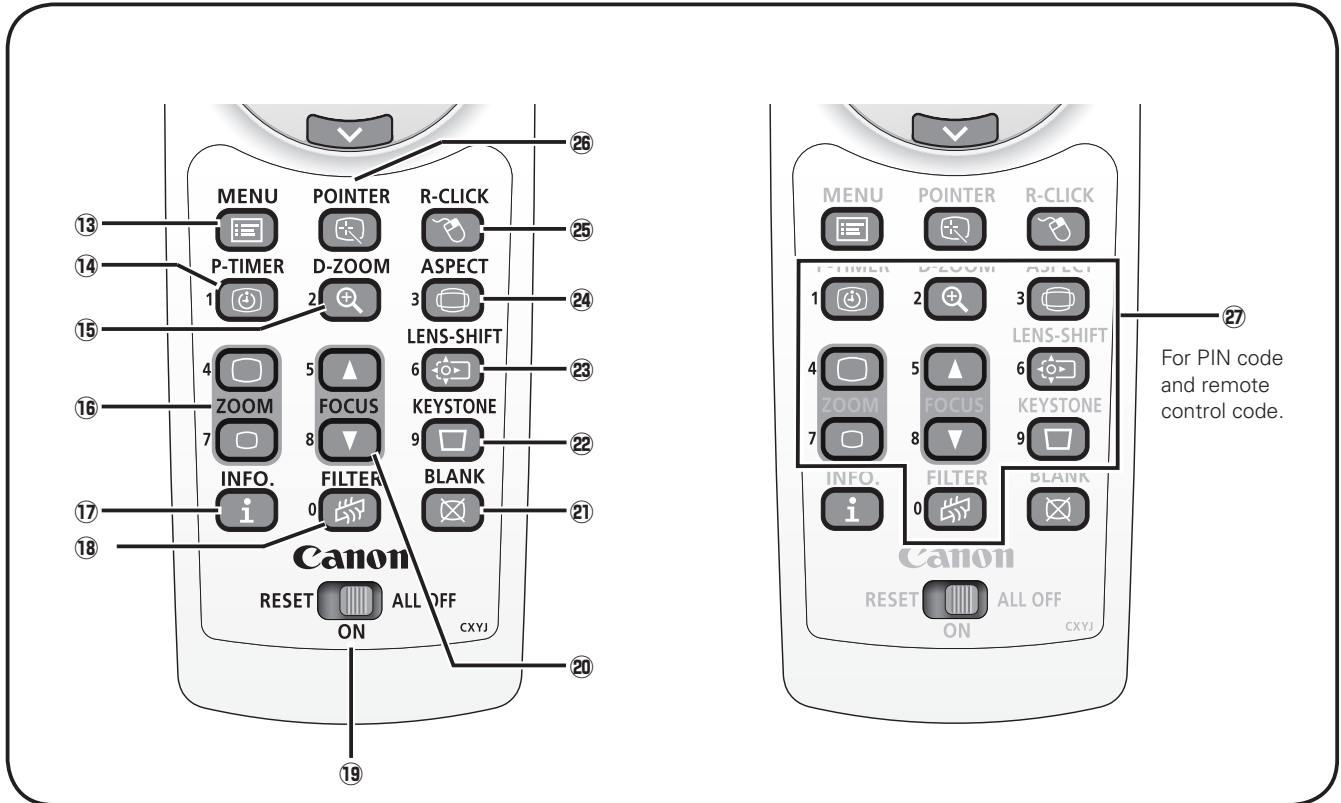

13 MENU button

Open or close the On-Screen Menu (p.25).

14 P-TIMER button

Operate the P-timer function (p.29).

15 D-ZOOM button

Select the Digital zoom +/- mode and resize the image (p.40).

16 ZOOM ▲▼ buttons

Zoom in and out the images (p.28).

17 INFO. button

Display the input source information (p.28).

18 FILTER button

Scroll the filter (p.29).

19 RESET/ON/ALL-OFF switch

When using the remote control unit, set this switch to "ON." Set it to "ALL OFF" for power saving when it is not in use. Slide this switch to "RESET" to initialize the remote control code.

20 FOCUS buttons

Adjust the focus (p.28).

21 BLANK button

Temporarily turn off the image on the screen (p.29).

22 KEYSTONE button

Correct keystone distortion (p.29).

23 LENS-SHIFT button

Select the Lens Shift function (p.28).

24 ASPECT button

Select the screen size (p.28).

25 R-CLICK button

Act as the right mouse button for wireless mouse operation (p.30).

26 POINTER button

Act as the On-Off switch for the Pointer (p.29, 30).

27 NUMBER buttons

Act as number buttons. Use these buttons when setting the remote control codes (p.16) or when entering the PIN code numbers (pp. 23, 50, 51, 54).

Remote Control Battery Installation

1 Open the battery compartment lid.

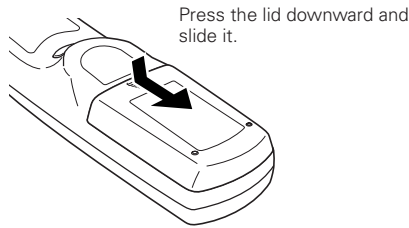

2 Install new batteries into the compartment.

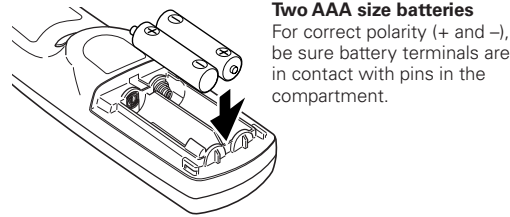

3 Replace the compartment lid.

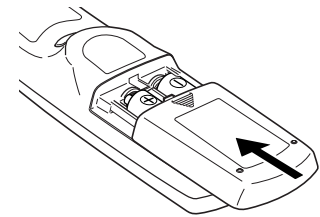

To insure safe operation, please observe the following precautions :

- Use two (2) AAA or LR03 type alkaline batteries.
- Always replace batteries in sets.
- Do not use a new battery with a used battery.
- Avoid contact with water or liquid.
- Do not expose the remote control unit to moisture or heat.
- Do not drop the remote control unit.
- If the battery has leaked on the remote control unit, carefully wipe the case clean and install new batteries.
- Risk of an explosion if battery is replaced by an incorrect type.
- Dispose of used batteries according to the instructions.

Remote Control Receivers and Operating Range

Point the remote control unit toward the projector (to Infrared Remote Receivers) when pressing the buttons. Maximum operating range for the remote control unit is about 16.4' (5 m) and 60 degrees in front and rear of the projector.

Infrared Remote Receivers are provided both in front and back of the projector. You can conveniently use both of the receivers (pp. 10, 51).

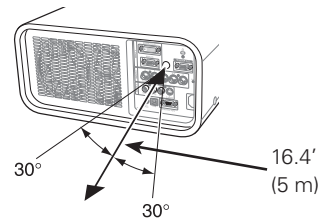
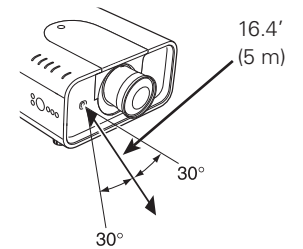

Wired Remote Control Transmitter

The remote control unit can be used as a wired remote control unit. Wired remote control unit helps you use the remote control unit outside of the operating range (16.4'/ 5 m). Connect the remote control unit and the projector with the remote control cable (sold separately). Connected with the remote control cable, the remote control unit does not emit wireless signal.

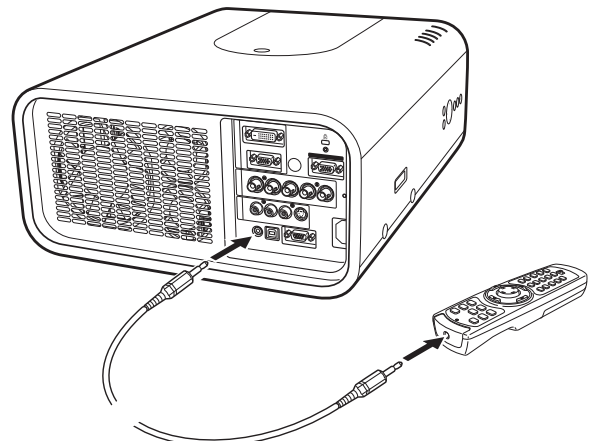

Remote Control Code

The eight different remote control codes (Code 1–Code 8) are assigned to this projector. Switching the remote control codes prevents interference from other remote control units when several projectors or video equipment next to each other are operated at the same time. Change the remote control code for the projector first before changing that for the remote control unit. See “Remote control” in the Setting Menu on page 51.

- 1** Press and hold the MENU and a number button (1–8) for more than 5 seconds to switch between the codes.
- 2** To initialize the remote control code, slide the RESET/ON/ALL-OFF switch to “RESET,” and then to “ON.” The initial code is set to Code 1.

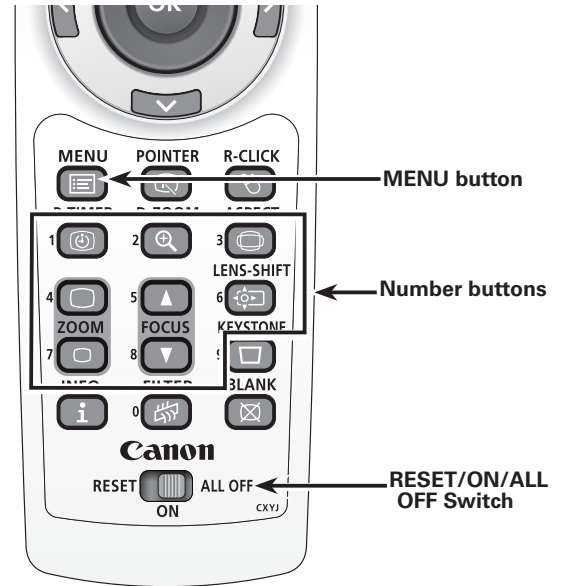

Press and hold the MENU and a number button (1–8) that corresponds to the remote control code for more than 5 seconds to switch between the codes.

Installation

Positioning the Projector

For projector positioning, see the figures below. The projector should be set perpendicularly to the plane of the screen.

✓Notes:

- The brightness in the room has a great influence on picture quality. It is recommended to limit ambient lighting in order to obtain the best image.
- All measurements are approximate and may vary from the actual sizes.

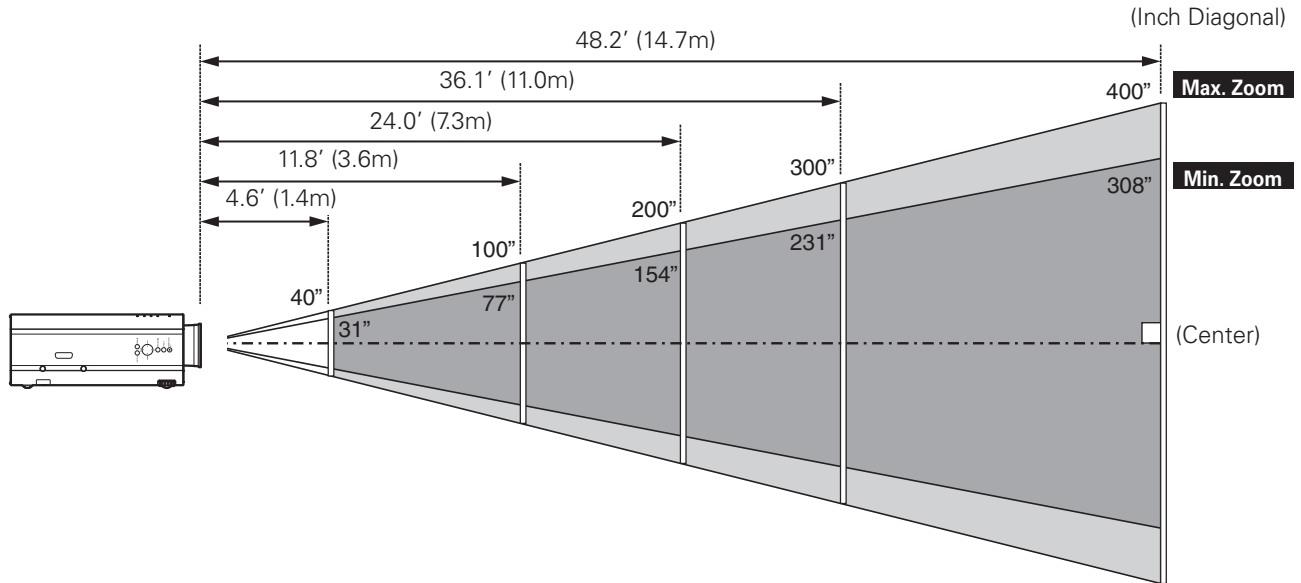

Screen Size (W x H) mm	40"	100"	200"	300"	400"
Zoom (min.)	5.9' (1.8 m)	15.4' (4.7 m)	30.8' (9.4 m)	46.6' (14.2 m)	—
Zoom (max.)	4.6' (1.4 m)	11.8' (3.6 m)	24.0' (7.3 m)	36.1' (11.0 m)	48.2' (14.7 m)

Adjustable Feet

Projection angle can be adjusted up to 6.5 degrees with the adjustable feet.

Rotate the adjustable feet and tilt the projector to the proper height; to raise the projector, rotate the both feet clockwise.

To lower the projector or to retract the adjustable feet, rotate the both feet counterclockwise.

To correct keystone distortion, press the KEYSTONE button on the remote control unit or select Keystone from the menu (see pages 14, 29, 40, 44).

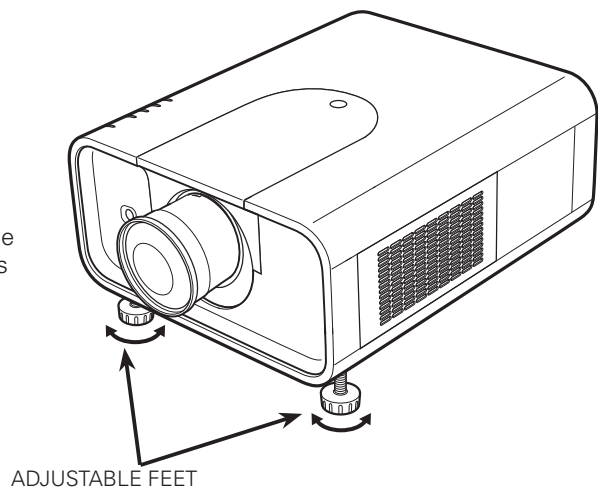

Lens Installation

When replacing the lens or using an optional lens, install the lens by following the instructions below. Ask the sales dealer for detailed information of the optional lens specifications.

Removing the lens

- 1** Shift the lens to the center position by using the Lens shift function (p. 27).
- 2** While pressing the top cover release button on the top cover, slide the top cover toward front to remove it
- 3** Slide the light-block sheet upward and remove it.
- 4** Hold the lens with one hand and pull the Lens Lock Lever upward with the other hand. Remove the lens from the projector.
*Do not touch the glass part of the lens with your hand.



CAUTION

Be careful when handling the lens. Do not drop.

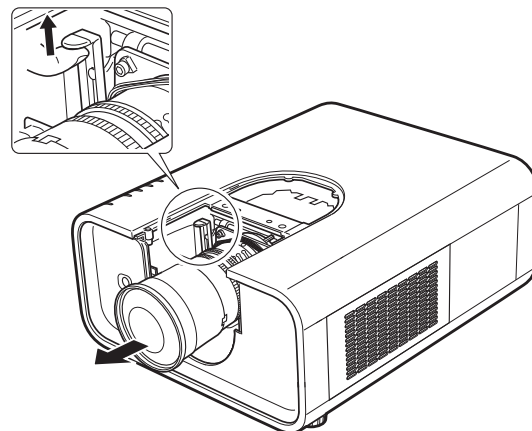
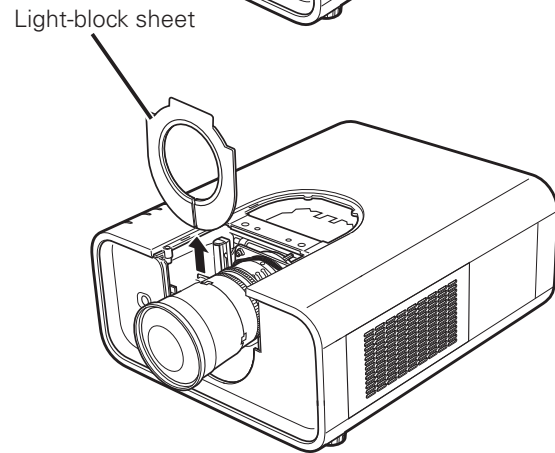
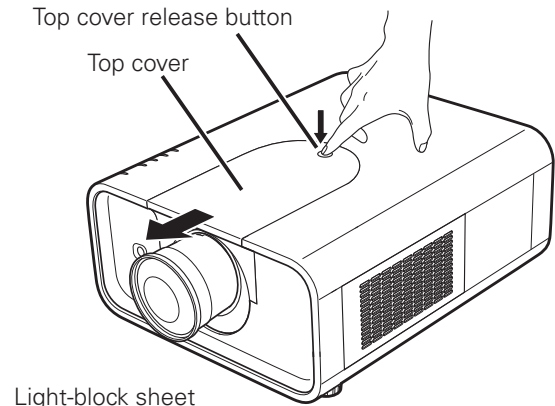

Attaching the lens to the projector

- 1** Fit the lens to the projector. Make sure that the lens is fully inserted to the projector.
- 2** Push the Lens Lock Lever downward. Make sure that the lens is properly locked.
- 3** Slide the light-block sheet in the groove to mount.
- 4** While pressing the top cover release button on the top cover, slide the top cover back to the projector.

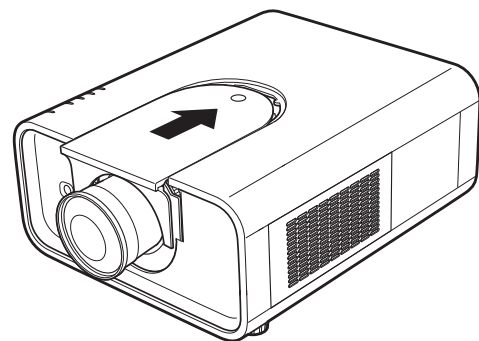
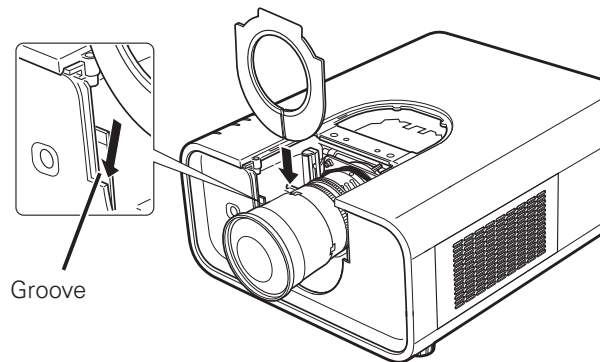
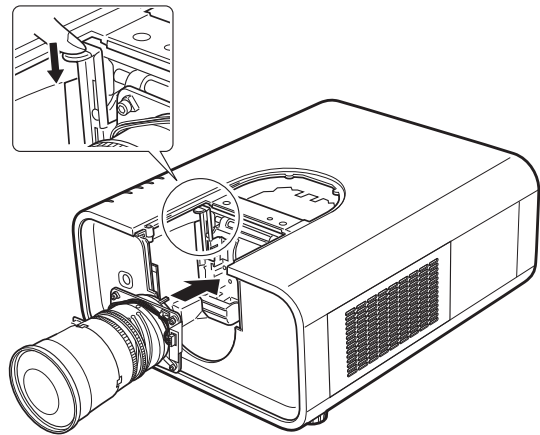

NOTES ON LENS INSTALLATION

- Do not touch or remove any parts except the lens and related parts. It may result in malfunctions, electrical shock, fire hazard or other accidents.
- Before installing or replacing the lens, check that the Model No. of the Projection Lens matches to the projector.
- For details of the lens and installation, contact the sales dealer where you purchased the projector.

Connecting to a Computer (Digital and Analog RGB)

Cables used for connection (* = Cables not supplied with this projector.)

- VGA Cable (One cable is supplied.)
- DVI-Digital Cable *
- BNC Cable *
- Serial Cross Cable*
- USB Cable

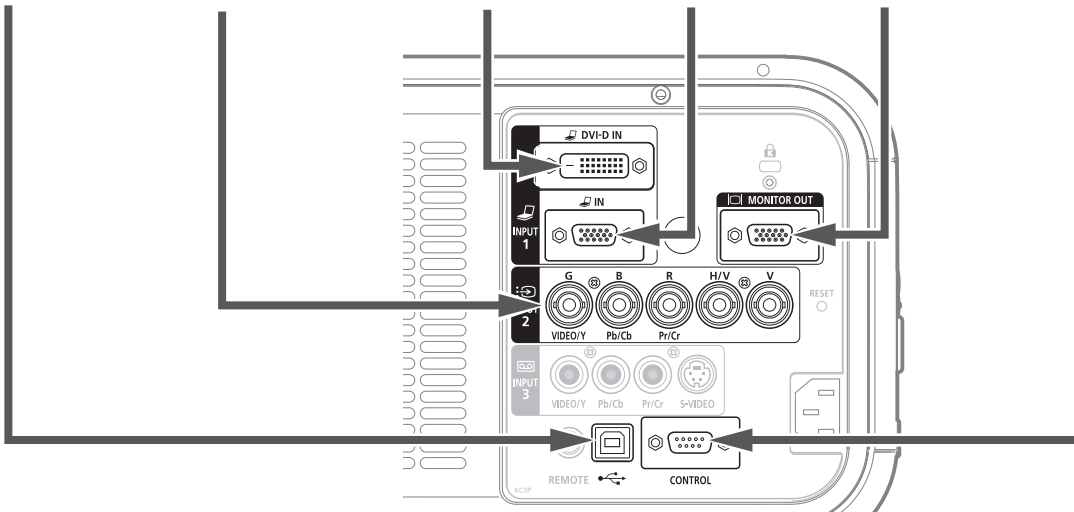
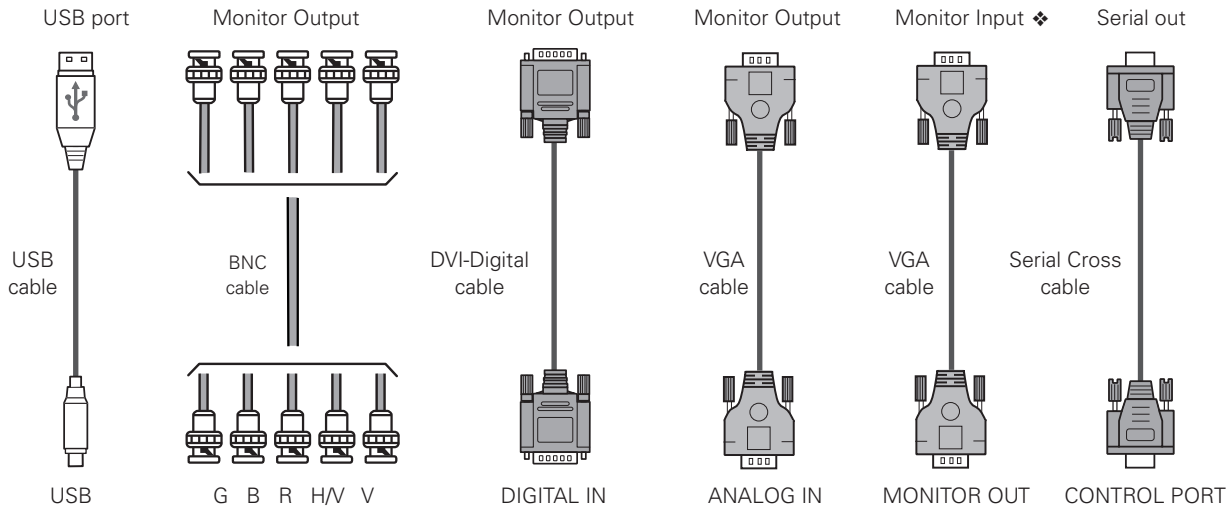
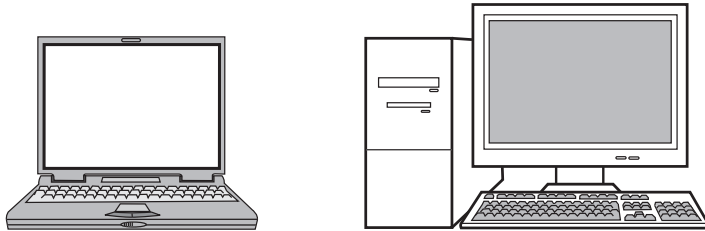

Unplug the power cords of both the projector and external equipment from the AC outlet before connecting cables.

❖ See the next page for the signals that can output to the MONITOR OUT terminal.

Connecting to Video Equipment (Video, S-Video)

Cables used for connection (* = Cables not supplied with this projector.)

- Video Cable (RCA x 1 or RCA x 3) *
- BNC Cable *
- S-VIDEO Cable *
- Scart-VGA Cable *

Monitor Out Signal Table

Input Terminal		Monitor Out	Cable
Input 1	D-sub15	RGB (PC analog)	YES
		RGB (SCART)	NO
	DVI-D	RGB (PC digital)	NO
		RGB (AV HDCP)	NO
Input 2	5BNC	RGB	YES
		Video	YES
		Y, Cb/Cr	YES
Input 3	RCA	Y, Cb/Cr	YES
	S-Video	S-video	NO
	Video	Video	YES
Network		NO	

* A cable with one end D-sub 15 and the other end (Black box) compatible with each equipment is necessary.



Unplug the power cords of both the projector and external equipment from the AC outlet before connecting cables.

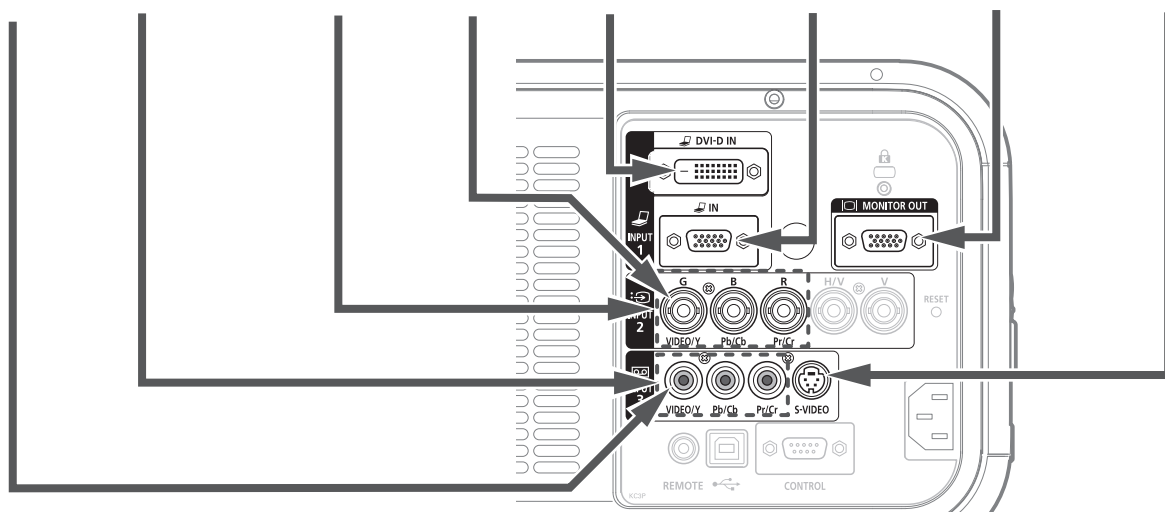
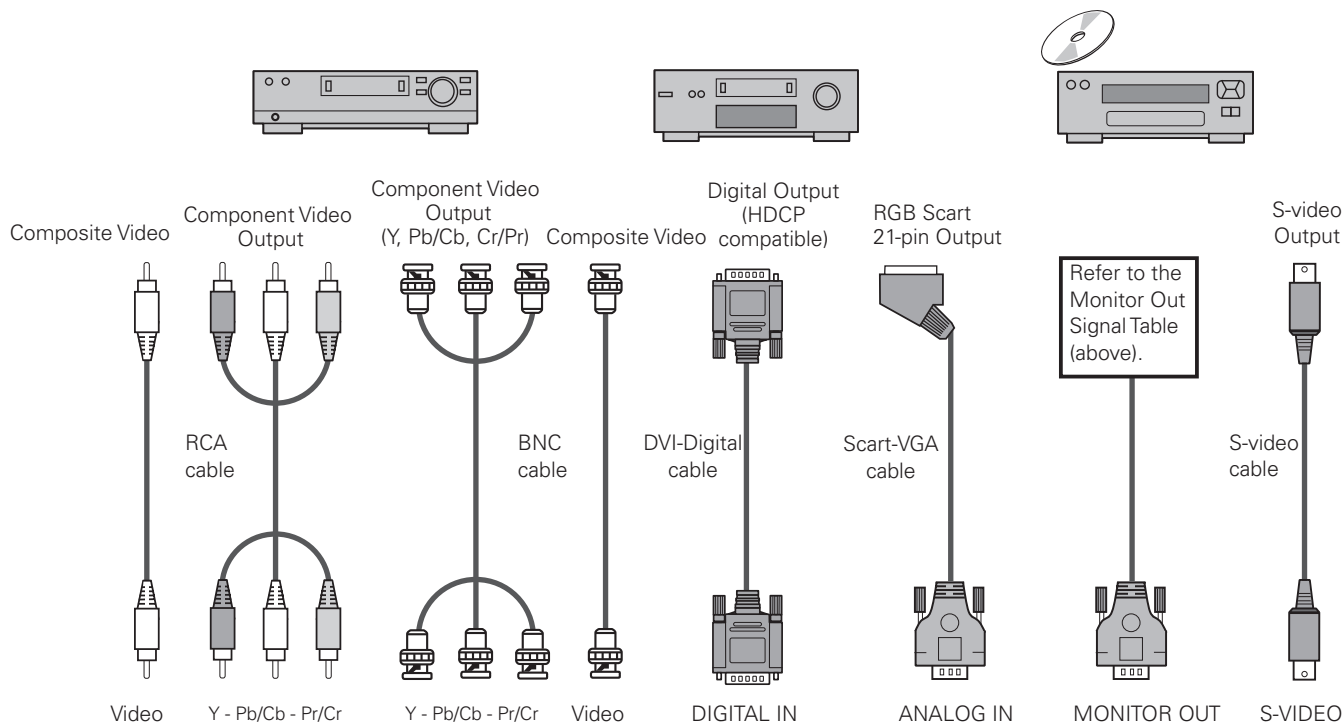

Installation

Connecting the AC Power Cord

This projector uses nominal input voltages of 100–120 V or 200–240 V AC and it automatically selects the correct input voltage. It is designed to work with single-phase power systems having a grounded neutral conductor. To reduce the risk of electrical shock, do not plug into any other type of power system.

If you are not sure of the type of power being supplied, consult your authorized dealer or service station.

Connect the projector with all peripheral equipment before turning on the projector.



CAUTION

For safety, unplug the AC power cord when the projector is not in use. When the projector is connected to an outlet with AC power cord, it is in stand-by mode and consumes a little electric power.

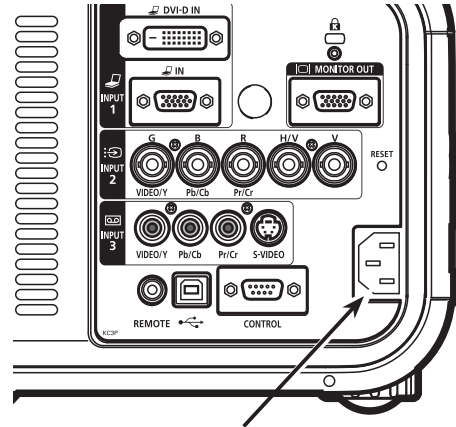

Connect the AC power cord (supplied) to the projector.

The AC outlet must be near this equipment and must be easily accessible.

NOTE ON THE POWER CORD

AC power cord must meet the requirements of the country where you use the projector.

Confirm the AC plug type with the chart below and proper AC power cord must be used.

If the supplied AC power cord does not match your AC outlet, contact your sales dealer.

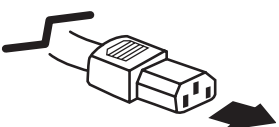
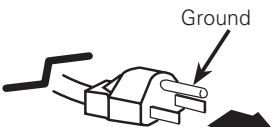
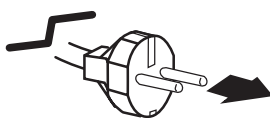
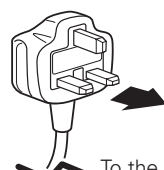
Projector side	AC Outlet side		
 <p>To POWER CORD CONNECTOR on your projector.</p>	<p>For the U.S.A. and Canada</p>  <p>To the AC Outlet. (120 V AC)</p>	<p>For Continental Europe</p>  <p>To the AC Outlet. (200–240 V AC)</p>	<p>For the U.K.</p>  <p>To the AC Outlet. (200–240 V AC)</p>

Basic Operation

Turning On the Projector

- 1** Complete peripheral connections (with a computer, VCR, etc.) before turning on the projector.
- 2** Connect the projector's AC power cord into an AC outlet. The LAMP indicator lights red and the POWER indicator lights green.
- 3** Press the POWER button on the side control or the ON button on the remote control unit. The LAMP indicator dims and the cooling fans start to operate. The preparation display appears on the screen and the countdown starts.
- 4** After the countdown, the input source that was selected the last time and the Lamp mode status icon (see page 51) appear on the screen.

If the projector is locked with a PIN code, PIN code Input Dialog Box will appear. Enter the PIN code as instructed below.

Enter a PIN code

Use the Point ▲▼ buttons on the side control or Number buttons on the remote control unit to enter a number.

When using side control

Use the Point ▲▼ buttons on the side control to select a number. Press the Point ► button to fix the number and move the red frame pointer to the next box. The number changes to "*" Repeat this step to complete entering a four-digit number. After entering the four-digit number, move the pointer to "Set." Press the OK button so that you can start to operate the projector.

When using remote control unit

Press the Number buttons on the remote control unit to enter a number (p.14). When you complete entering a four-digit number, the pointer moves to "Set." Press the OK button so that you can start to operate the projector.

If you fixed an incorrect number, use the Point ◀ button to move the pointer to the number you want to correct, and then enter the correct number.

If you entered an incorrect PIN code, "PIN code" and the number (****) will turn red for a moment. Enter the correct PIN code all over again.

What is PIN code?

PIN (Personal Identification Number) code is a security code that allows the person who knows it to operate the projector. Setting a PIN code prevents unauthorized use of the projector.

A PIN code consists of a four-digit number. Refer to the PIN code lock function in the Setting Menu on page 53-54 for locking operation of the projector with your PIN code.

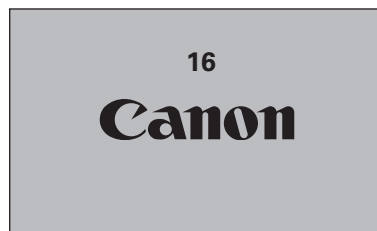

The preparation display will disappear after 30 seconds.

Selected Input Source and Lamp mode

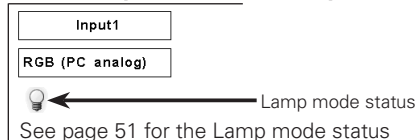

✓ Note:

- The Lamp replacement icon and the Filter replacement or the Filter cartridge replacement icon may appear on the screen depending on the usage state of the projector.
- When the filter cartridge replacement icon keeps appearing on the screen at turning on the projector for some time and no action is taken to replace the filter cartridge, the projector will be automatically shut down in 3 minutes after turning on to protect the projector. (pp. 56-58, 70)

PIN code Input Dialog Box

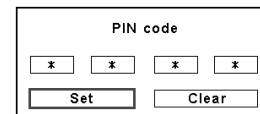

OK After the OK icon disappears, you can operate the projector.

✓ Note:

- When the Logo select function is set to "Off," the logo will not be shown on the screen (p.49).
- When the "Countdown off" or "Off" is selected in the Display function, the countdown will not be shown on the screen (p.48).
- During the countdown period, all operations are invalid.
- If the correct PIN code number is not entered within three minutes after the PIN code dialog box appeared, the projector will be turned off automatically.
- The "1234" is set as the initial PIN code at the factory.

Turning Off the Projector

- 1** Press the POWER button on the side control or the STAND-BY button on the remote control unit, and "Power off?" appears on the screen.
- 2** Press the POWER button on the side control or the STAND-BY button on the remote control unit again to turn off the projector. The LAMP indicator lights bright and the POWER indicator turns off. After the projector is turned off, the cooling fans operate for 90 seconds. You cannot turn on the projector during this cooling down period.
- 3** When the projector has cooled down enough, the POWER indicator lights green and then you can turn on the projector. To unplug the AC power cord, wait until the projector is completely cooled down.

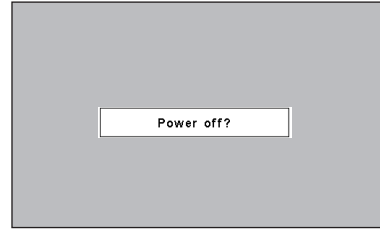

"Power off?" disappears after 4 seconds.



TO MAINTAIN THE LIFE OF THE LAMP, ONCE YOU TURN THE PROJECTOR ON, WAIT AT LEAST FIVE MINUTES BEFORE TURNING IT OFF. DO NOT UNPLUG THE AC POWER CORD WHILE COOLING FANS ARE RUNNING OR BEFORE THE POWER INDICATOR LIGHTS GREEN AGAIN. OTHERWISE IT WILL RESULT IN SHORTENING OF THE LAMP LIFE.



DO NOT OPERATE THE PROJECTOR CONTINUOUSLY WITHOUT REST. CONTINUOUS USE MAY RESULT IN SHORTENING THE LAMP LIFE. TURN OFF THE PROJECTOR AND LET STAND FOR ABOUT AN HOUR IN EVERY 24 HOURS.

✓ Note:

- When the On start function is set to "On," the projector will be turned on automatically by connecting the AC power cord to an AC outlet (p.52).
- The running speed of cooling fans is changed according to the temperature inside the projector.
- Do not put the projector in a case before the projector is cooled enough.
- If the WARNING TEMP. indicator blinks red, see "Warning Indicators" on page 63.
- The projector cannot be turned on during the cooling period with the POWER indicator turned off. You can turn it on again after the POWER indicator becomes green again.

How to Operate the On-Screen Menu

The projector can be adjusted or set via the On-Screen Menu. For each adjustment and setting procedure, refer to the respective sections in this manual.

- 1** Press the MENU button on the side control or the remote control unit to display the On-Screen Menu.
- 2** Use the Point ◀▶ buttons to select a Menu icon. Use the Point ▲▼ buttons to select an item in the selected menu.
- 3** Press the OK button to show the item data. Use the Point ◀▶ buttons to adjust the values.

To close the On-Screen Menu, press the MENU button again.

✓ Note:

- The selected item is not active until the OK button is pressed.

Side Control

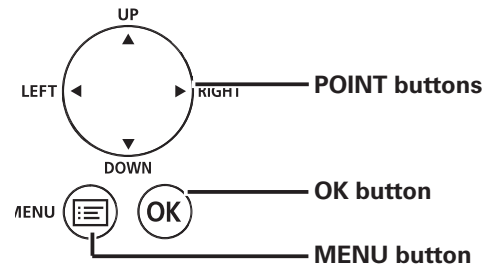

Remote Control Unit

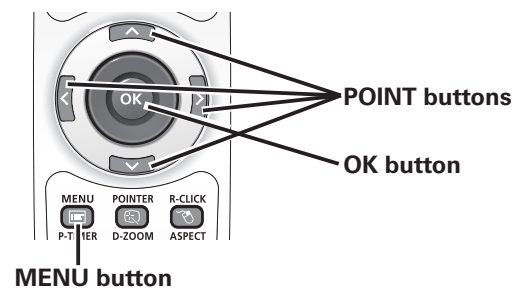

On-Screen Menu

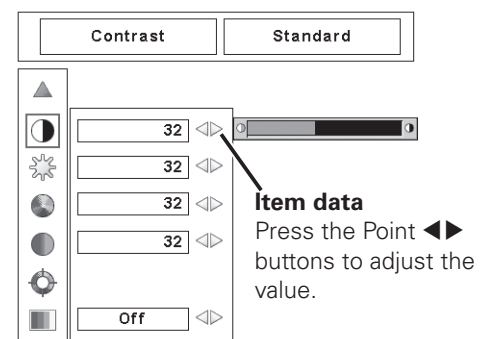
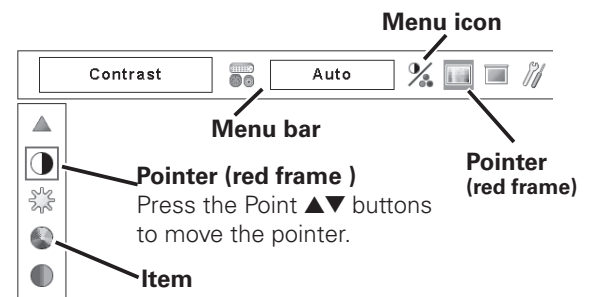

Basic Operation

Menu Bar

For detailed functions of each menu, see "Menu Tree" on pages 66-68.

For Computer Source

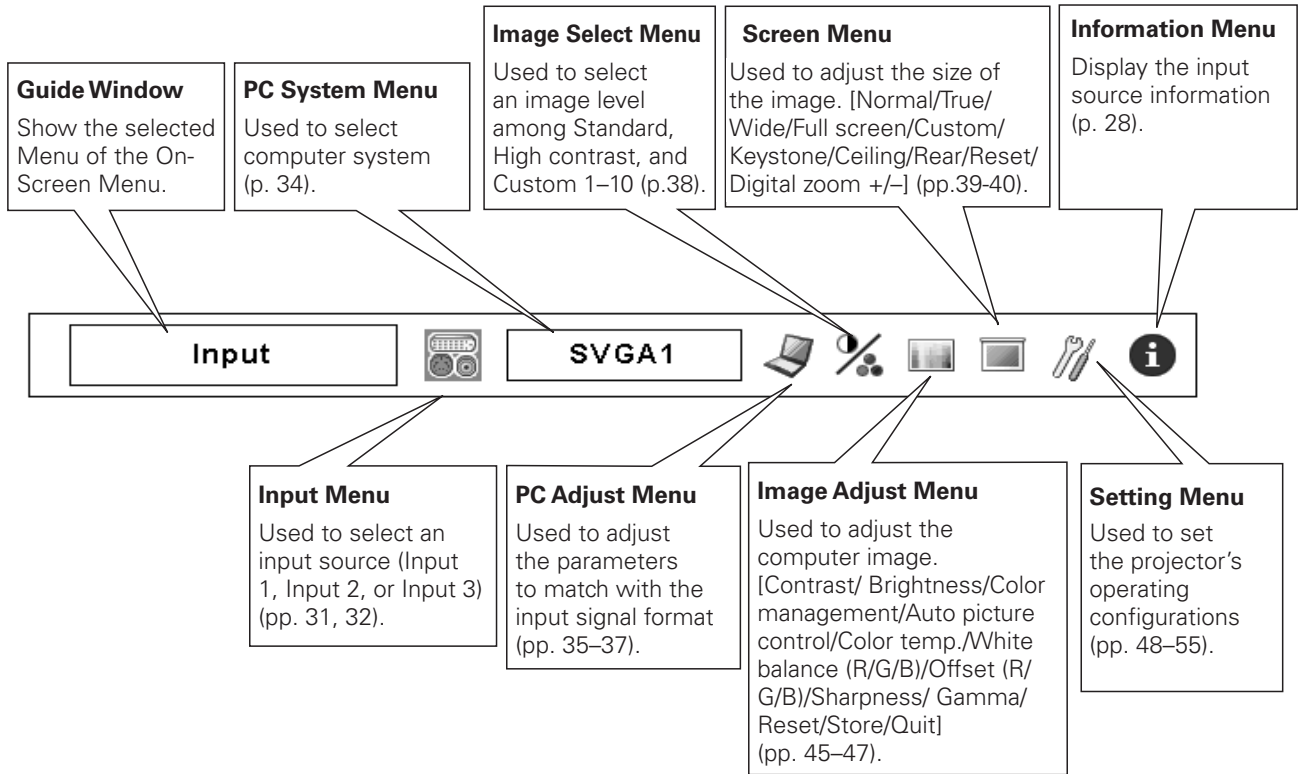

For Video Source

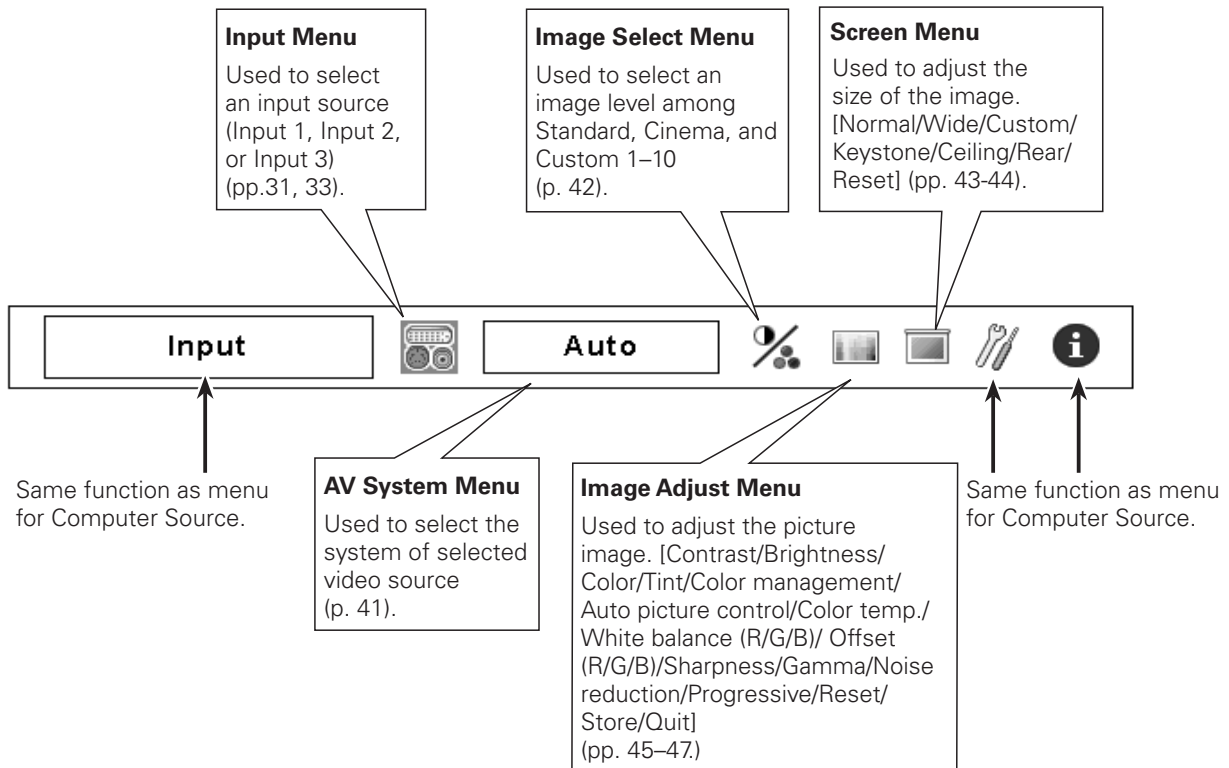

Operating with Projector Control

Lens Operation

The following lens operation can be made with the Lens button on the side control.

Press the LENS button to enter each lens operation mode. The selected adjustment display appears on the screen.

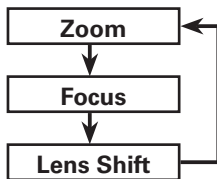

Side Control

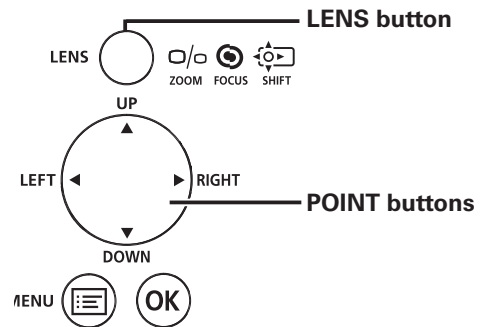

Zoom Adjustment

Display "Zoom" on the screen. Use the Point ▲▼ buttons to zoom in and out the image.



Focus Adjustment

Display "Focus" on the screen. Use the Point ▲▼ buttons to adjust focus of the image.

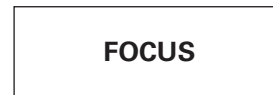

Lens Shift Adjustment

Display "Lens shift" on the screen. Use the Point ▲▼◀▶ buttons to position the screen to the desired point without having picture distortion.

The screen can be moved up or down to 50 percent, or sideways up to 10 percent from the central axis of the lens shift.

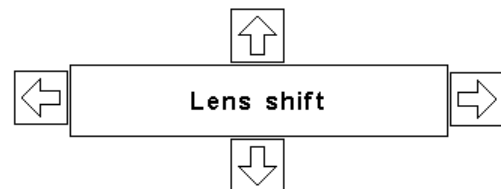

✓ Note:

- The arrow disappears at the maximum lens shift in each direction.
- The arrow turns red when the lens shift comes to the center position of the screen.

Operating with Remote Control Unit

Using the remote control unit for some frequently used operations is advisable. Just pressing one of the buttons enables you to make the desired operation quickly without calling up the On-Screen Menu.

FREEZE button

Press the FREEZE button on the remote control unit to freeze the picture on the screen. To cancel the FREEZE function, press the FREEZE button again or press any other button.

AUTO PC button

Press the AUTO PC button on the remote control unit to operate the Auto PC Adj. function. The computer screen adjustment can be done easily by pressing this button. See page 35 for details.

D-ZOOM button

Press the D-ZOOM button on the remote control unit to enter to the Digital zoom +/- mode. See page 40 for details.

ASPECT button

Press the ASPECT button on the remote control unit to select the desired screen size. The selected screen size symbol appears on the screen for 4 seconds. See pages 39 to 40 and 43 to 44 for details.

Press and hold the ASPECT button for more than 5 seconds to return all the screen size adjustment setting to the factory default setting.

LENS-SHIFT button

See page 27 for details.

ZOOM buttons

Press the ZOOM buttons on the remote control unit to zoom in and out the image.

FOCUS buttons

Press the FOCUS buttons on the remote control unit to adjust focus of the image.

INFO. button

Information display can be used to confirm the current operating condition of the projector and the signal being projected through the projector.

Press the INFO. button on the remote control unit to display the information window on the screen. To hide the information window, press the INFO. button again or Point  buttons.

The information window can also be selected from the menu.

Remote Control Unit

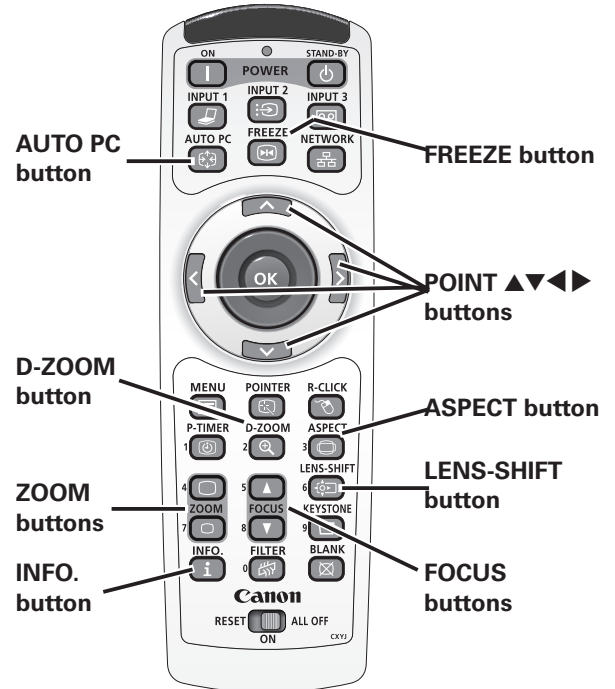



✓ Note:

- See the next page for the description of other buttons.

Information Menu



Information Menu

Input	Input 1	
	RGB (PC Analog)	
H-sync freq.	15.7 KHz	
V-sync freq.	30.0 Hz	
Aspect	Normal	
Language	English	
Lamp status		
Power management	Ready	5 Min.
Security	Key lock	
	PIN code lock	Off
Remote control	Code 1	

* The H- and V-sync freq. values described in this figure may be different from the actual values.

FILTER button

Press and hold the FILTER button for more than 5 seconds to operate electrically operated filter to replace the filter.

✓ Note:

- When the filter is replaced, the total accumulated time of the filter use is automatically set to 0.

BLANK button

Press the BLANK button on the remote control unit to black out the image. To restore to normal, press the BLANK button again or press any other button.



"Blank" disappears after 4 seconds.

MOUSE POINTER button

Move the pointer on the screen with this button.

POINTER button

Press POINTER button on the remote control unit to display the Pointer on the screen.

P-TIMER button

Press the P-TIMER button on the remote control unit. The Timer display "00 : 00" appears on the screen and starts to count time (00 : 00–59 : 59).

To stop the P-TIMER, press the P-TIMER button.

To cancel the P-TIMER, press the P-TIMER button again.

KEystone button

Press the KEystone button on the remote control unit. The "Keystone" appears on the screen.

Use the Point ▲▼◀▶ buttons to correct keystone distortion. The keystone adjustment can be stored (pp.40, 44).

Reduce the upper width with Point ▲ button.

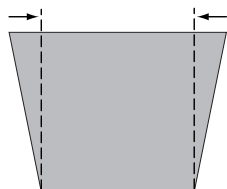

Reduce the lower width with Point ▼ button.

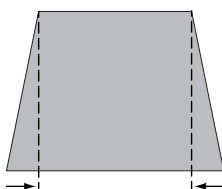

Reduce the left part with Point ◀ button.

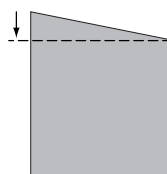

Reduce the right part with Point ▶ button.

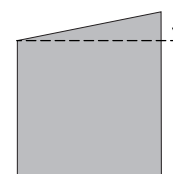

Remote Control Unit

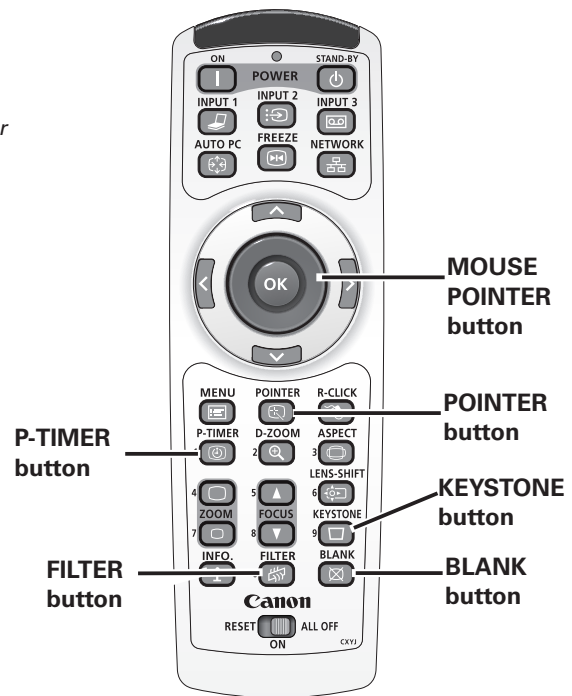

✓ Note:

- See the previous page for the description of other buttons.



P-Timer display

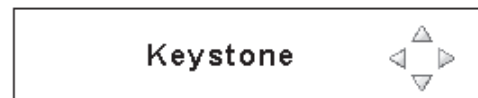

- The white arrows indicate that there is no correction.
- A red arrow indicates the direction of correction.
- An arrow disappears at the maximum correction.
- If you press the KEystone button on the remote control unit again while the Keystone dialog box is being displayed, the keystone adjustment will be canceled.
- "Keystone" disappears after 10 seconds.

Pointer Function

You can move the Pointer of the projector with the remote control unit to emphasize a part of the projected image.

- 1 Press the POINTER button to activate the Pointer function.
- 2 Use the MOUSE POINTER button to move the Pointer.
- 3 To cancel the Pointer function, press the POINTER button again or press any other button.

Pointer

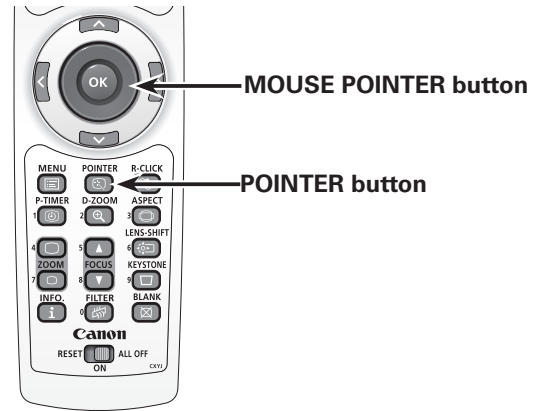
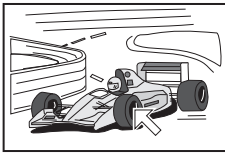

✓ Note:

- You can choose the pattern of Pointer (Arrow/Cross/Dot) in the Setting Menu (p. 52)

Wireless Mouse Operation

The remote control unit can be used as a wireless mouse for your computer.

- 1 Before operating the wireless mouse, connect your computer and the projector with the supplied USB cable (p. 20).
When the Pointer function is used, the wireless mouse is not available.
- 2 When a USB cable is connected to the computer and the projector, turn on the projector first, then the computer. If you turn on the computer first, the wireless mouse function may not operate properly.

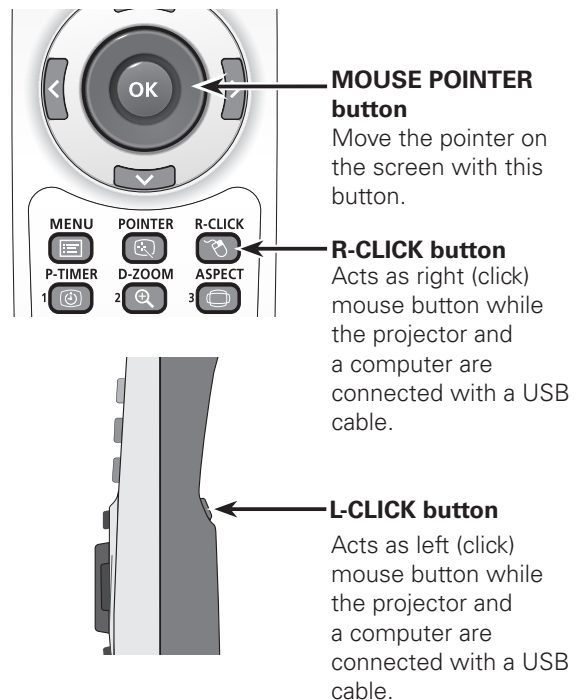

Input Selection

Input

Side Control

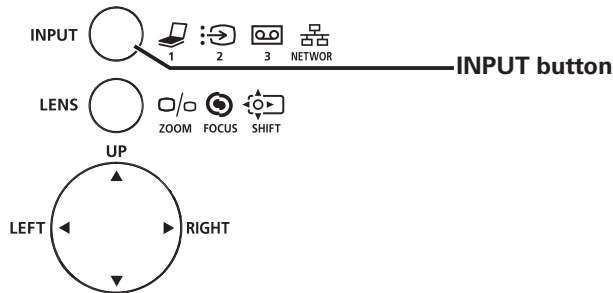

Side Control button operation

INPUT button

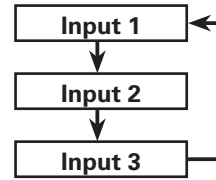

Side Control Operation

Press the INPUT button on the side control. It switches to INPUT 1, INPUT 2, and INPUT 3 as you press the INPUT button.

Before using the INPUT button on the side control, you must select a correct input source by On-Screen Menu and the latest input source will be displayed.

Remote Control Unit

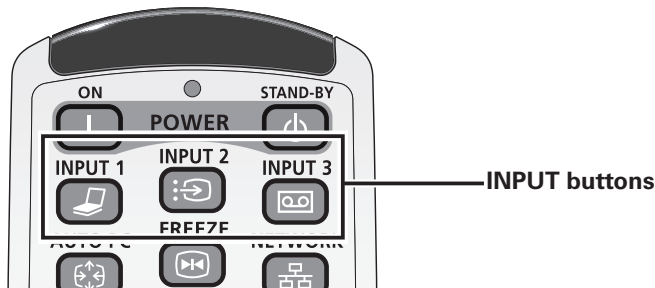

Remote Control button operation

INPUT 1 button

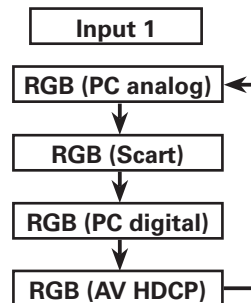

INPUT 2 button

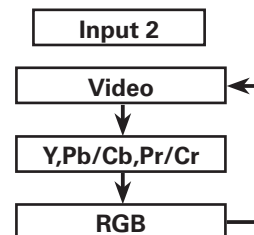

INPUT 3 button

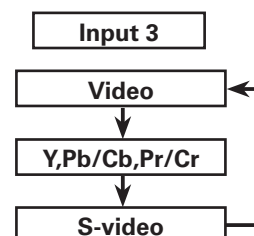

Remote Control Operation

Press the INPUT 1, INPUT 2, or INPUT 3 buttons on the remote control unit. The input source appears on the screen as you press each button. Select the connected input source.

Computer Input Source Selection

Menu Operation

WHEN SELECTING INPUT 1 (COMPUTER INPUT TERMINALS)

- 1 Press the MENU button to display the On-Screen Menu. Use the Point ◀▶ buttons to move the red frame pointer to the INPUT Menu icon.
- 2 Use the Point ▲▼ buttons to move the red arrow pointer to the desired input and then press the OK button. The Source Select Menu appears.
- 3 Use the Point ▲▼ buttons to select the desired source and then press the OK button.

RGB (PC analog)

When your computer is connected to the INPUT 1 (ANALOG) terminal, select RGB (PC analog).

RGB (PC digital)

When your computer is connected to INPUT 1 (DIGITAL) terminal, select RGB (PC digital).

✓ Note:

- *INPUT SOURCE* changes if the *INPUT 1* button on the remote control unit is pressed.
- *HDCP (High-bandwidth Digital Content Protection)* is a system for protecting digital entertainment content which is delivered by *DVI (Digital Visual Interface)* from being copied. The specification of *HDCP* is decided and controlled by *Digital Content Protection, LLC*. Should the specification be changed, this projector may not display the digital content protected by *HDCP*.

INPUT MENU

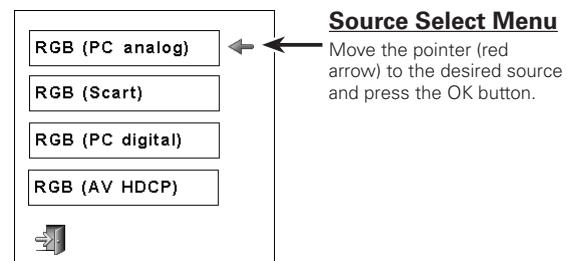
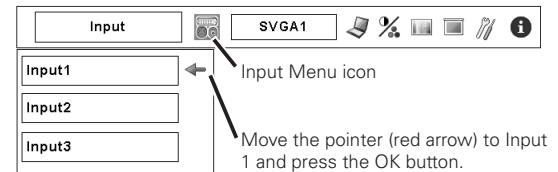

WHEN SELECTING INPUT 2 (5 BNC INPUT JACKS)

When connecting the computer output [5 BNC Type (Green, Blue, Red, Horiz. Sync, and Vert. Sync.)] from the computer to G, B, R, H/HV, and V jacks:

RGB

When your computer is connected to the INPUT 2 (5 BNC INPUT JACKS) terminal, select RGB.

INPUT MENU

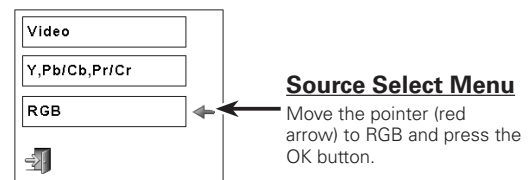
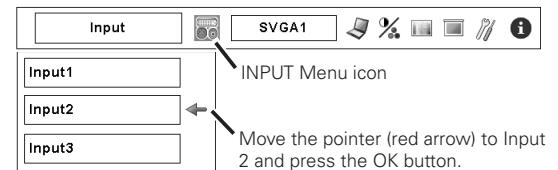

Video Input Source Selection

Menu Operation

WHEN SELECTING INPUT 1 (COMPUTER INPUT TERMINALS)

When connecting to video equipment, select the type of Video source in the Source Select Menu.

RGB (Scart)

When scart video equipment is connected to the INPUT 1 (ANALOG) terminal, select RGB (Scart).

RGB (AV HDCP)

If the HDCP-compatible signal source is connected to the INPUT 1 (DIGITAL) terminal, select RGB (AV HDCP).

WHEN SELECTING INPUT 2 (5 BNC INPUT JACKS)

When connecting to video equipment, select the type of Video source in the Source Select Menu.

Video

When the video input signal is connected to the VIDEO jack, select Video.

Y, Pb/Cb, Pr/Cr

When the video input signal is connected to the Y-Pb/Cb-Pr/Cr jacks, select Y, Pb/Cb, Pr/Cr.

WHEN SELECTING INPUT 3 (AV TERMINALS)

When connecting to video equipment, select the type of Video source in the Source Select Menu.

Video

When the video input signal is connected to the VIDEO jack, select Video.

Y, Pb/Cb, Pr/Cr

When the video input signal is connected to the Y-Pb/Cb-Pr/Cr jacks, select Y, Pb/Cb, Pr/Cr.

S-Video

When the video input signal is connected to the S-VIDEO jack, select S-Video.

INPUT MENU

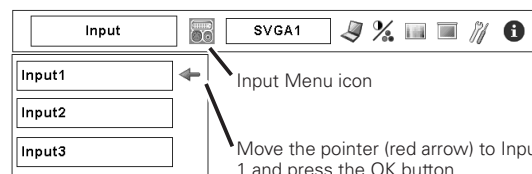

Input 1

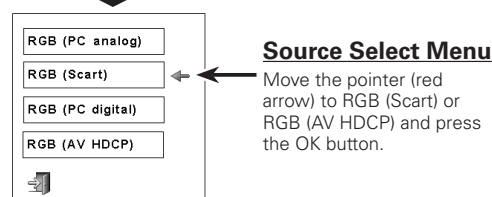

INPUT MENU

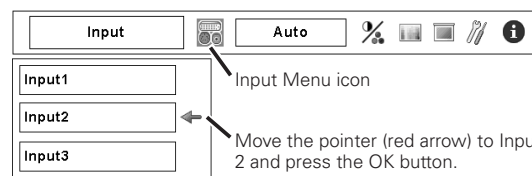

Input 2

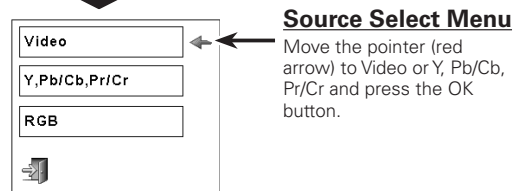

INPUT MENU

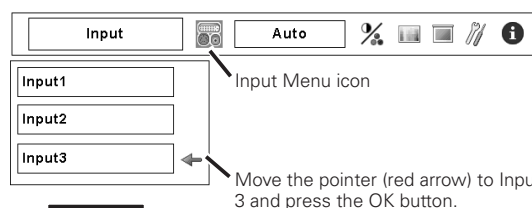

Input 3

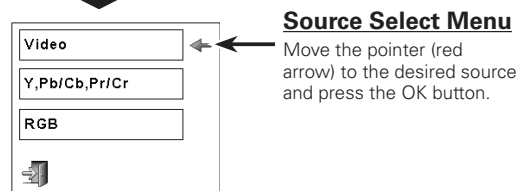

Computer Input

Computer System Selection

Automatic Multi-Scan System

This projector automatically tunes to various types of computers based on VGA, SVGA, XGA, SXGA, SXGA+, WXGA, or UXGA (refer to "Compatible Computer Specifications" on pages 71–72). If a computer is selected as a signal source, this projector automatically detects the signal format and tunes to project a proper image without any additional settings. (Some computers need to be set manually.)

One of the following messages may appear when:

Auto

The projector cannot recognize the connected signal conforming to the provided PC Systems. The "Auto" is displayed on the System Menu box and the Auto PC Adjustment function works to display proper images. If the image is not projected properly, a manual adjustment is required. (pp. 36–37.)

There is no signal input from the computer. Check the connection between your computer and the projector. (See "Troubleshooting" on page 64.)

Mode 1

The preset system is manually adjusted in the PC Adjust Menu. The adjusted data can be stored in the Mode 1–10. (pp. 36–37)

SVGA 1

PC systems provided in this projector is chosen. The projector chooses a proper system provided in the projector and displays it.

* Mode 1 and SVGA 1 are examples.

Selecting Computer System Manually

PC system can also be selected manually.

- 1 Press the MENU button to display the On-Screen Menu. Use the Point ◀▶ buttons to move the red frame pointer to the PC System Menu icon.
- 2 Use the Point ▲▼ buttons to move the red arrow pointer to the desired system, and then press OK button.

PC SYSTEM MENU

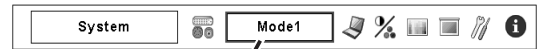

PC System Menu icon
Selected system is displayed.

PC SYSTEM MENU

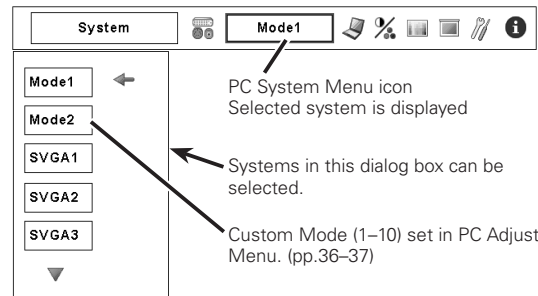

PC System Menu icon
Selected system is displayed

Systems in this dialog box can be selected.

Custom Mode (1–10) set in PC Adjust Menu. (pp.36–37)

Auto PC Adjustment

Auto PC Adjustment function is provided to automatically adjust Fine sync, Total dots, Horizontal and Vertical positions to conform to your computer.

Direct Operation

The Auto PC adjustment function can be operated directly by pressing the AUTO PC button on the remote control unit.

Remote Control Unit

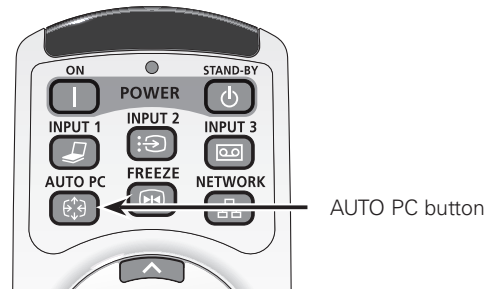

Menu Operation

Auto PC adj.

- 1 Press the MENU button to display the On-Screen Menu. Use the Point ◀▶ buttons to move the red frame pointer to the PC Adjust Menu icon.
- 2 Use the Point ▲▼ buttons to move the red frame pointer to the AUTO PC adj. icon and then press the OK button twice.

To store the adjusted parameters.

The adjusted parameters from the Auto PC Adjustment can be stored in the projector. Once the parameters are stored, the setting can be done just by selecting Mode in PC SYSTEM Menu (p.34). See MANUAL PC ADJUSTMENT on pages 36–37.

✓ Note:

- Fine sync, Total dots, Horizontal and Vertical position of certain computers cannot be fully adjusted with the Auto PC Adjustment function. When the image is not provided properly with this operation, manual adjustments are required. (pp. 36–37.)
- Auto PC Adjustment cannot be operated in Digital Signal Input on the DVI terminal and “480p,” “575p,” “480i,” “575i,” “720p,” “1035i,” or “1080i” is selected on the PC SYSTEM Menu.
- Depending on the condition of signals and the type and length of cables, the signals may not be properly viewed.

PC ADJUST MENU

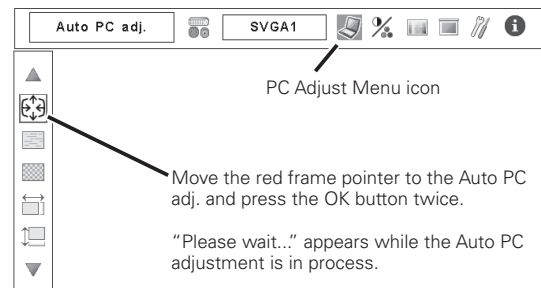

Manual PC Adjustment

Some computers employ special signal formats which may not be tuned by Multi-Scan system of this projector. Manual PC Adjustment enables you to precisely adjust several parameters to match those special signal formats. The projector has 10 independent memory areas to store those parameters manually adjusted. It allows you to recall the setting for a specific computer.

✓ Note: The PC Adjust Menu cannot be operated when the digital signal input on the DVI terminal is selected on PC System Menu.

- 1** Press the MENU button to display the On-Screen Menu. Use the Point ◀▶ buttons to move the red frame pointer to the PC Adjust Menu icon.
- 2** Use the Point ▲▼ buttons to move the red frame pointer to the desired item and then press the OK button to display the adjustment dialog box. Use the Point ◀▶ buttons to adjust the setting value.

Fine sync

Use the Point ◀▶ buttons to adjust the value, eliminating a flicker from the image displayed (from 0 to 31).

Total dots

Use the Point ◀▶ buttons to adjust the number of total dots in one horizontal period to match your PC image.

Position H

Use the Point ◀▶ buttons to adjust the horizontal picture position.

Position V

Use the Point ◀▶ buttons to adjust the vertical picture position.

Current mode

Press the OK button to show H-sync freq. and V-sync freq. of the connected computer.

Clamp

Use the Point ◀▶ buttons to adjust the clamp level. When the image has dark bars, try this adjustment.

Display area H

Use the Point ◀▶ buttons to adjust the horizontal area displayed by this projector.

Display area V

Use the Point ◀▶ buttons to adjust the vertical area displayed by this projector.

PC ADJUST MENU

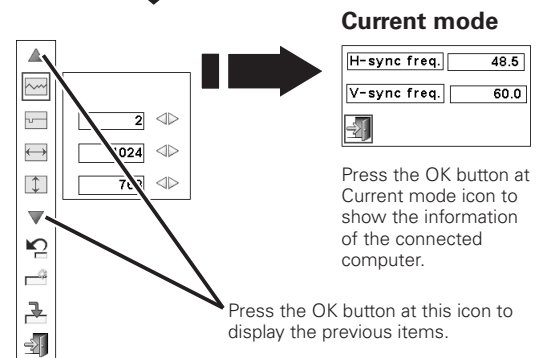
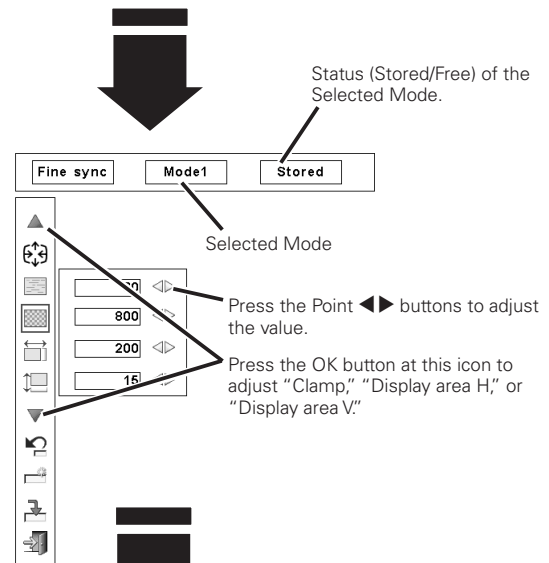
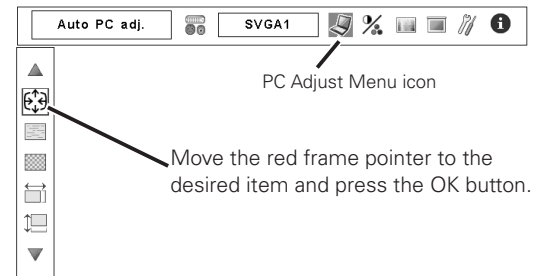



Reset

To reset the adjusted data, select Reset and press the OK button. A confirmation box appears and then select [Yes]. All adjustments will return to their previous figures.



Mode free

To clear the adjusted data, select Mode free and then press the OK button. Move the red arrow pointer to the Mode that you want to clear and then press the OK button.



Store

To store the adjusted data, select Store and then press the OK button. Move the red arrow pointer to one of the Mode 1 to 10 in which you want to store, and then press the OK button.



Quit

Exit the PC Adjust Menu.

To clear the adjusted data.

Where to free?

▲									
Mode1	Stored	0	0	0	0	0	0	0	←
Mode2	Free	0	0	0	0	0	0	0	
Mode3	Free	0	0	0	0	0	0	0	
Mode4	Free	0	0	0	0	0	0	0	
Mode5	Free	0	0	0	0	0	0	0	
▼									

OK?

Yes ←

No

Close this dialog box.

Confirmation box appears and then select [Yes].

To store the adjusted data.

Where to store?

▲									
Mode1	Stored	0	0	0	0	0	0	0	←
Mode2	Free	0	0	0	0	0	0	0	
Mode3	Free	0	0	0	0	0	0	0	
Mode4	Free	0	0	0	0	0	0	0	
Mode5	Free	0	0	0	0	0	0	0	
▼									

This Mode has stored parameters.

Vacant

Values of "Total dots," "Position H," "Position V," "Display area H," and "Display area V."

Close this dialog box.

OK?

Yes ←

No

Confirmation box appears and then select [Yes].

Image Level Selection

Menu Operation

- 1** Press the MENU button to display the On-Screen Menu. Use the Point ◀▶ buttons to move the red frame pointer to the Image Select Menu icon.
- 2** Use the Point ▲▼ buttons to move the red frame pointer to the desired image level and then press the OK button.



Standard

Normal picture level preset on the projector.



High contrast

Picture level with improved halftone for graphics.



Custom 1–10

User preset picture adjustment in the Image Adjust Menu. (p. 47)

IMAGE SELECT MENU

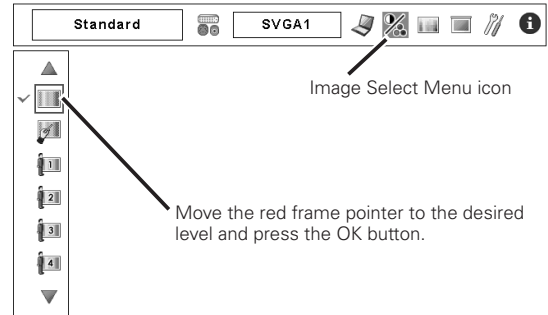

Screen Size Adjustment

Select the desired screen size that conforms to the input signal source.

- 1 Press the MENU button to display the On-Screen Menu. Use the Point ◀▶ buttons to move the red frame pointer to the Screen Menu icon.
- 2 Use the Point ▲▼ buttons to move the red frame pointer to the desired function and then press the OK button.



Normal

Provide the image at the normal computer aspect ratio of 4:3.



True

Provide the image in its original size. When the original image size is larger than the screen size (1024 x 768), the projector enters to the panning mode automatically. Use the Point ▲▼◀▶ buttons to pan the image. When adjusted, the arrows will turn red. When reached to the correction limits, the arrows will disappear.



Wide

Provide the image to fit the wide video aspect ratio (16:9) by expanding the image width uniformly. This function can be used to provide the squeezed video signal at 16:9.



Full screen

Provides the full screen image.



Custom

Adjust the screen scale and position manually with this function. Press the OK button at Custom and the "Custom" is displayed on the screen for a few seconds. To display the Aspect dialog box, press the OK button at Custom again and then the Aspect dialog box appears.

- Scale H/V..... Adjust the Horizontal/Vertical screen scale.
- H&V..... When set to "On," the aspect ratio is fixed. The "Scale V" appears dimmed and becomes unavailable. Adjust "Scale H," then the screen scale is automatically modified based on the aspect ratio.
- Position H/V..... Adjust the Horizontal/Vertical screen position.
- Common Save the adjusted scale to all the inputs. Press the OK button at Common to display a confirmation box. To save the scale, press the OK button at "Yes." When Custom is selected, the saved scale is used.
- Reset..... Reset the all adjusted values. Press the OK button at Reset to display a confirmation box. To reset, press the OK button at "Yes."

SCREEN MENU

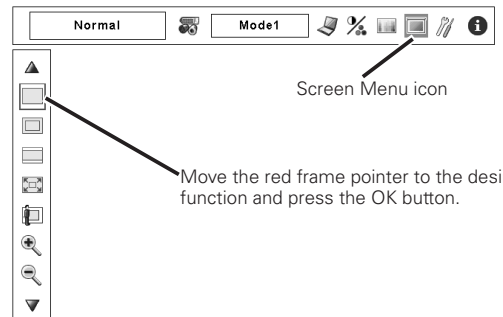

✓ Note:

- The projector cannot display any resolution higher than 1600 x 1200. If your computer's screen resolution is higher than 1600 x 1200, lower the resolution before connecting the projector.
- The image data other than XGA (1024 x 768) is modified to fit the screen size in initial mode.
- True, Full screen, and Digital zoom +/- cannot be selected when no signal is detected in the PC System Menu. (p.34)

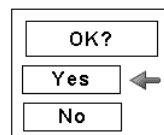
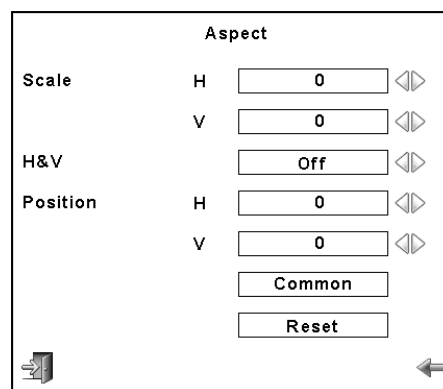

Press the OK button at Common or Reset, to display a confirmation box.

✓ Note:

- When no signal is detected, "Normal" is set automatically and the Aspect dialog box disappears.
- The adjustable range for Scale H/V and Position H/V is limited depending on the input signal.



Keystone

This function is used to store or reset the keystone correction when the AC power cord is unplugged. Use the Point ◀▶ buttons to switch between each option.

Store. . . Keep the keystone correction even when the AC power cord is unplugged.

Reset . . Release the keystone correction when the AC power cord is unplugged.

To correct keystone distortion, press the OK button. The Keystone dialog box appears. Use the Point ▲▼◀▶ buttons to correct keystone distortion. (p.29)



Ceiling

When this function is set to "On," the picture is top/bottom and left/right reversed. This function is used to project the image from a ceiling-mounted projector.



Rear

When this function is set to "On," the picture is left/right reversed. This function is used to project the image from the rear of the screen.



Reset

This function returns all adjusted values to the factory default settings. Press the OK button at Reset to display a confirmation box. To reset, press the OK button at "Yes."



Quit

Exit the Screen Size Adjustment Menu.

For zooming in and out the images



Digital zoom +

Select Digital zoom +. The On-Screen Menu disappears and "D- zoom +" appears. Press the OK button to expand the image size. Use the Point ▲▼◀▶ buttons to pan the image. The Panning function can work only when the image is larger than the screen size.

You can also enter the Digital zoom + mode by pressing the D-ZOOM button on the remote control unit.



Digital zoom -

Select Digital zoom -. The On-Screen Menu disappears and "D- zoom -" appears. Press the OK button to compress the image size.

You can also enter the Digital zoom - mode by pressing the D-ZOOM button on the remote control unit.

To exit the Digital Zoom +/- mode, press any button except the D-ZOOM , OK, and Point buttons.

SCREEN MENU

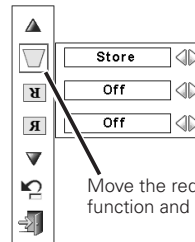

Move the red frame pointer to the desired function and press the OK button.

Ceiling

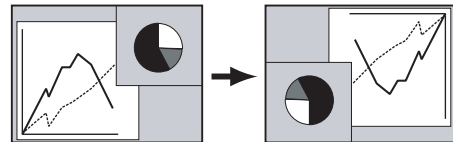

Rear

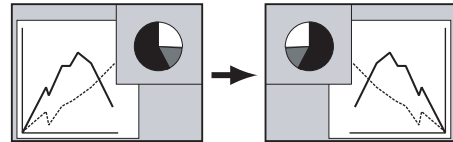

✓ Note:

- The panning function may not operate properly if the stored Mode in the PC Adjust Menu is used. (p. 37)
- The minimum compression ratio can be limited depending on the input signal or when the Keystone function is working.
- Digital zoom +/- cannot be selected when Full screen or True is selected.

Video Input

Video System Selection

- 1 Press the MENU button to display the On-Screen Menu. Use the Point ◀▶ buttons to move the red frame pointer to the AV System Menu icon.
- 2 Use the Point ▲▼ buttons to move the red arrow pointer to the desired system and then press the OK button.

Video Jack or S-Video Jack

Auto

The projector automatically detects an incoming video system, and adjusts itself to optimize its performance.

When Video System is PAL-M or PAL-N, select the system manually.

PAL/SECAM/NTSC/NTSC4.43/PAL-M/PAL-N

If the projector cannot reproduce proper video image, select a specific broadcast signal format from among PAL, SECAM, NTSC, NTSC 4.43, PAL-M, and PAL-N.

AV SYSTEM MENU (VIDEO OR S-VIDEO)

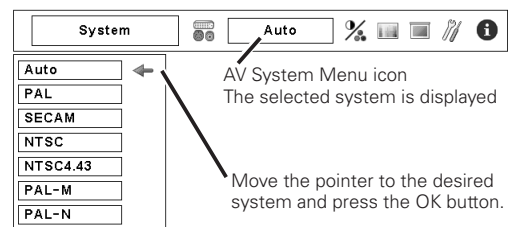

Y, Pb/Cb, Pr/Cr Jacks

Auto

The projector automatically detects an incoming video signal, and adjusts itself to optimize its performance.

When the Video System is 1035i or 1080i, select the system manually.

COMPONENT VIDEO SIGNAL FORMAT

If the projector cannot reproduce proper video image, select a specific component video signal format from among 480i, 575i, 480p, 575p, 720p, 1035i, and 1080i.

AV SYSTEM MENU (COMPONENT VIDEO)

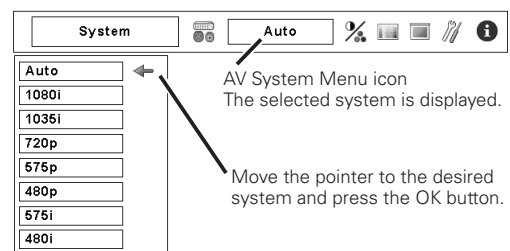

Image Level Selection

Menu Operation

- 1** Press the MENU button to display the On-Screen Menu. Use the Point ◀▶ buttons to move the red frame pointer to the Image Select Menu icon.
- 2** Use the Point ▲▼ buttons to move the red frame pointer to the desired image level and then press the OK button.



Standard

Normal picture level preset on the projector.



Cinema

Picture level adjusted with fine tone.



Custom 1–10

User preset picture adjustment in the Image Adjust Menu. (p. 47)

IMAGE SELECT MENU

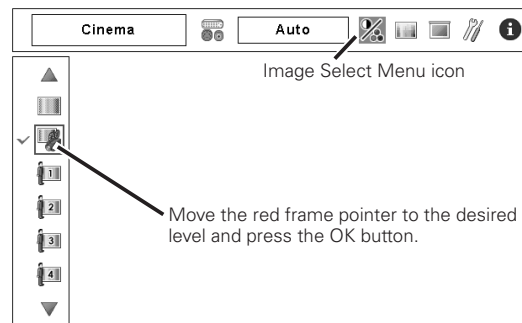

Screen Size Adjustment

- 1 Press the MENU button to display the On-Screen Menu. Use the Point ◀▶ buttons to move the red frame pointer to the Screen Menu icon.
- 2 Use the Point ▲▼ buttons to move the red frame pointer to the desired function and then press the OK button.



Normal

Provide the image at the normal video aspect ratio of 4:3.



Wide

Provide the image at the wide screen ratio of 16:9.



Custom

Adjust the screen scale and position manually with this function. Press the OK button at Custom and the "Custom" is displayed on the screen for a few seconds. To display the Aspect dialog box, press the OK button at Custom again and then the Aspect dialog box appears.

- Scale H/V Adjust the Horizontal/Vertical screen scale.
- H&V When set to "On," the aspect ratio is fixed. The "Scale V" appears dimmed and becomes unavailable. Adjust "Scale H," then the screen scale is automatically modified based on the aspect ratio.
- Position H/V Adjust the Horizontal/Vertical screen position.
- Common Save the adjusted scale to all the inputs. Press the OK button at Common to display a confirmation box. To save the scale, press the OK button at "Yes." When Custom is selected, the saved scale is used.
- Reset Reset the all adjusted values. Press the OK button at Reset to display a confirmation box. To reset, press the OK button at "Yes."

SCREEN MENU

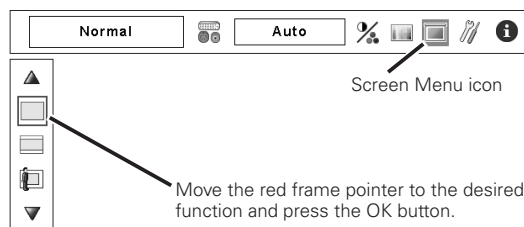

✓ Note:

- Wide cannot be operated when "720p," "1035i," or "1080i" is selected on AV System Menu (p.41).

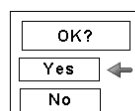
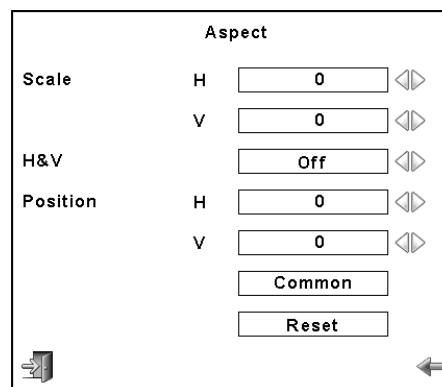

Press the OK button at Common or Reset, to display a confirmation box.

✓ Note:

- When no signal is detected, "Normal" is set automatically and the Aspect dialog box disappears.
- The adjustable range for Scale H/V and Position H/V is limited depending on the input signal.

Video Input



Keystone

This function is used to store or reset the keystone correction when the AC power cord is unplugged. Use the Point ◀▶ buttons to switch between each option.

Store. . . Keep the keystone correction even when the AC power cord is unplugged.

Reset . . . Release the keystone correction when the AC power cord is unplugged.

To correct keystone distortion, press the OK button. The Keystone dialog box appears. Use the Point ▲▼◀▶ buttons to correct keystone distortion. (p.29)



Ceiling

When this function is set to "On," the picture is top/bottom and left/right reversed. This function is used to project the image from a ceiling-mounted projector.



Rear

When this function is set to "On," the picture is left/right reversed. This function is used to project the image from the rear of the screen.



Reset

This function returns all adjusted values to the factory default settings. Press the OK button at Reset to display a confirmation box. To reset, press the OK button at "Yes."



Quit

Exit the Screen Size Adjustment Menu.

SCREEN MENU

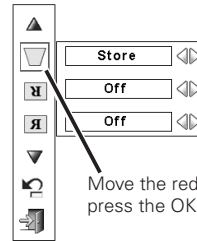

Move the red frame pointer to a function and press the OK button.

Ceiling

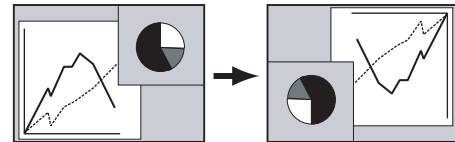

Rear

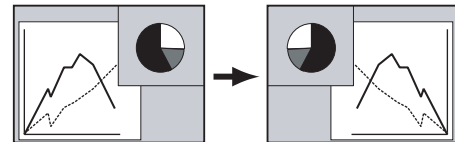

Picture Image

Image Adjustment

- 1 Press the MENU button to display the On-Screen Menu. Use the Point ◀▶ buttons to move the red frame pointer to the Image Adjust Menu icon.
- 2 Use the Point ▲▼ buttons to move the red frame pointer to the desired item and then press the OK button to display the adjustment dialog box. Use the Point ◀▶ buttons to adjust the setting value.



Contrast

Press the Point ◀ button to decrease contrast; press the Point ▶ button to increase the contrast (from 0 to 63).



Brightness

Press the Point ◀ button to decrease the brightness; press the Point ▶ button to increase the brightness (from 0 to 63).



Color *

Press the Point ◀ button to decrease the intensity of the color; press the Point ▶ button to increase the intensity of the color (from 0 to 63).



Tint *

Press the Point ◀▶ buttons to adjust the tint value to obtain proper color balance (from 0 to 63).



Color Management

The Color Management function can be used to adjust the LEVEL, PHASE, and GAMMA of the selected display colors (except for black, white, and gray) on the screen and replace these colors with other colors if required.

You can store up to eight (8) color management data.

- 1 Use the Point ▲▼ buttons to move the red frame pointer to Color Management, and then press the OK button. The projected image freezes, and the COLOR MANAGEMENT POINTER appears.
- 2 Use the Point ▲▼◀▶ buttons to move the pointer to the spot where you want to adjust the color and then press the OK button. The COLOR SELECTION window appears, and the color in the center of the pointer is selected and you can adjust the color.
- 3 Use the Point ▲▼◀▶ buttons to adjust the LEVEL and PHASE of the color, and then press the OK button to confirm the setting. Then use the Point ▲▼ buttons to adjust the GAMMA for the color and press the OK button to accept the setting. After adjusting, press the OK button to go to the COLOR MANAGEMENT LIST.

COLOR SELECTION MODE

LIST

Go to the COLOR MANAGEMENT LIST.

IMAGE ADJUST MENU

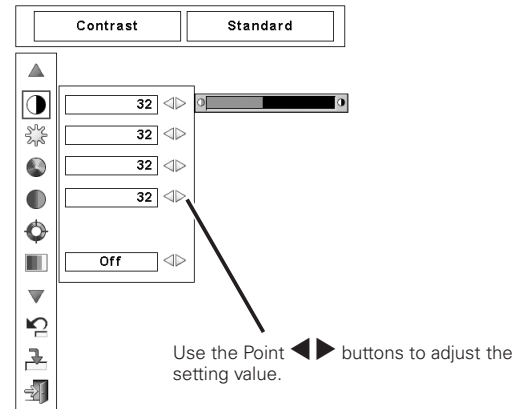
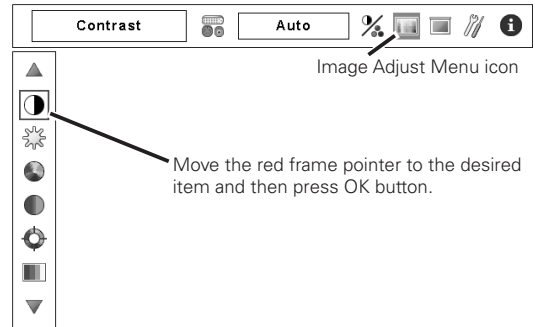

POINTER MODE

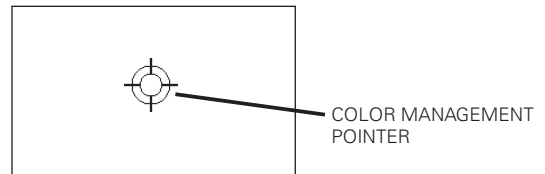

✓ Note:

- * Displayed only in Video Input.
- Tint cannot be selected when the video system is PAL, SECAM, PAL-M, or PAL-N (p.41).

COLOR SELECTION MODE (continued)

COLOR M.

Return to the COLOR MANAGEMENT POINTER. (If you press the MENU button on the side control or the remote control unit, it returns to the COLOR MANAGEMENT POINTER and you will need to reselect and readjust the color.)

MENU

Return to the IMAGE ADJUST Menu. Any settings that have been changed will not be stored. To store the changed settings, be sure to select "LIST" and go to the COLOR MANAGEMENT LIST.

- 4** In the COLOR MANAGEMENT LIST, the adjusted color data are checkmarked. You can decide whether or not to apply the adjusted color data in the list to the projected image (see below).

LIST MODE



Clear the check mark if you do not want to apply the adjusted color data; select the check mark and then press the OK button. The check mark disappears.

COLOR PALETTE

Return to the COLOR SELECTION mode so that you can readjust the setting for the color in that line. (This option is not available if the check mark is cleared.)

DEL

Select the DEL box if you want to delete the adjusted data. Press the OK button and a confirmation box appears and then select [Yes]

ALL DEL

Delete all the data in the list. Press the OK button and a confirmation box appears and then select [Yes].

MENU

The same function as stated above.

COLOR M.

The same function as stated above.



Auto picture control

Use the Point ◀▶ buttons to select the desired Auto picture control position (Off, L1 or L2).

Off Auto picture control OFF position.

L1 Auto picture control LEVEL 1 position.

L2 Auto picture control LEVEL 2 position.



Color temp.

Use the Point ◀▶ buttons to select the desired Color temp. level (High, Mid, Low, or XLow).

COLOR SELECTION MODE

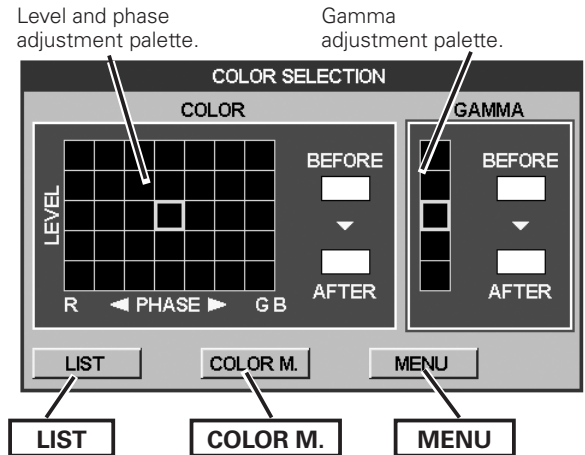

LIST MODE

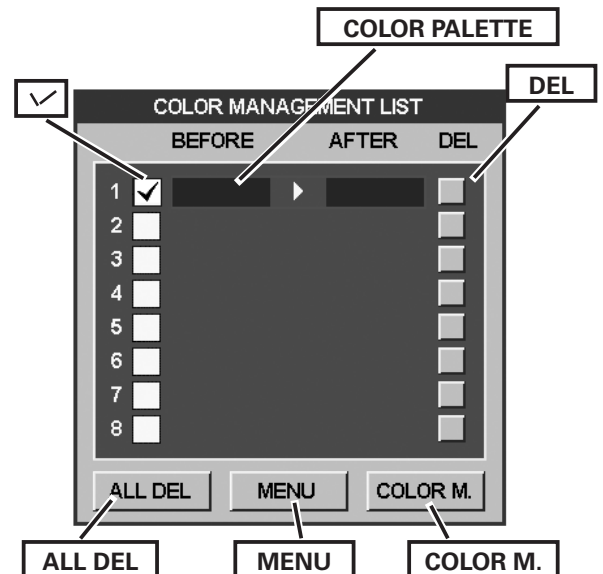



White balance (Red/Green/Blue)

Press the Point ◀ button to lighten red/green/blue tone; press the Point ▶ button to deepen red/green/blue tone (from 0 to 63).



Offset (Red/Green/Blue)

Press the Point ◀ button to lighten red/green/blue tone of the black level of an image; press the Point ▶ button to deepen red/green/blue tone of the black level of an image (from 0 to 63).



Sharpness

Press the Point ◀ button to decrease the sharpness of the image; press the Point ▶ button to increase the sharpness of the image (from 0 to 31).



Gamma

Use the Point ◀▶ buttons to adjust the gamma value to obtain a better balance of contrast (from 0 to 15).



Noise reduction *

Noise interference on the screen can be reduced. Press the Point ◀▶ buttons to change the noise reduction mode.

- Off Noise reduction mode is "Off"
- On Noise reduction mode is "On"



Progressive *

An interlaced video signal can be displayed in progressive mode. Press the Point ◀▶ buttons to change the progressive scan mode.

- Off Progressive scan mode is "Off."
- On Progressive scan mode is "On."
- Film For watching a film. With this function, the projector reproduces pictures faithful to the original film quality.



Reset

To reset the adjusted data, select Reset and press the OK button. A confirmation box appears and then select [Yes]. All adjustments will return to their previous figures.



Store

To store the adjusted data, move the red frame pointer to the Store icon and press the OK button. The Image Level Menu appears. Move the red arrow pointer to any of the Custom 1 to 10 in which you want to set and press the OK button. A confirmation box appears and then select [Yes].



Quit

Exit the Image Adjust Menu.

✓ Note:

- * Displayed only in Video Input.
- When the White balance Red, Green, or Blue is adjusted, the Color temp. level will change to "Adj."
- The Film mode in the Progressive function cannot be selected when the video signal format is 1080i or 1035i.
- Progressive cannot be selected when "480p," "575p," or "720p" is selected (p.41).

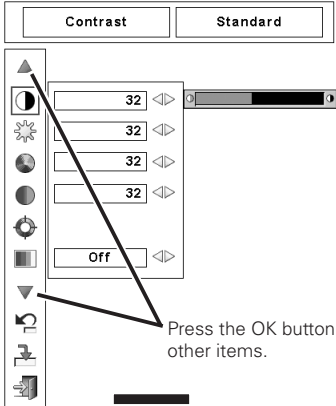

Press the OK button at this icon to display other items.

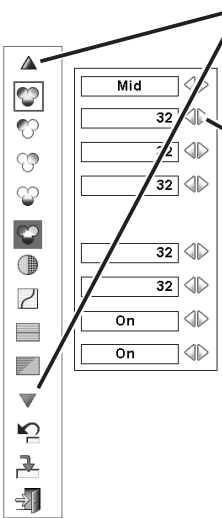

Press the OK button at this icon to display the previous items.

Press the Point ◀▶ buttons to adjust the setting value.

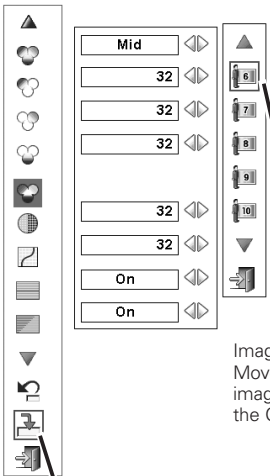

Image Level Menu Move the red frame pointer to an image item to be set and then press the OK button.

Store icon Press the OK button at this icon to store the adjustment.

Setting

Setting

This projector has a Setting menu that allows you to set up other various functions.

- 1 Press the MENU button to display the On-Screen Menu. Use the Point ◀▶ buttons to move the red frame pointer to the Setting Menu icon.
- 2 Use the Point ▲▼ buttons to move the red frame pointer to the desired item and then press the OK button. The Setting dialog box appears.

Language

The language used in the On-Screen Menu is available in English, German, French, Italian, Spanish, Portuguese, Dutch, Swedish, Russian, Chinese, Korean, or Japanese.

Menu

This function allows you to adjust the position of the On-Screen Display and the value adjustment bar in the Picture Image Adjustment Menu.

Position

This function is used to adjust the On-Screen Menu display position. Press the OK button and the adjustment screen appears (arrows appear). Use the Point ▲▼◀▶ buttons to adjust the position. After making the adjustment, press the OK button to return to the Menu screen.

Simple menu

When this function is set to "On," the value adjustment bar in the Picture Image Adjustment Menu appears on the screen.

Display

This function decides whether to display On-Screen Displays.

- On Shows all the On-Screen Displays. Use this function when you want to project images after the lamp becomes bright enough. The factory default setting is in this option.
- Countdown Off. . . Show the input image instead of the countdown when turning on the projector. Use this function when you want to project the image as early as possible even when the lamp is not bright enough.
- Off Hide the On-Screen Displays except:
 - On-Screen Menu
 - "Power off?" (p.24)
 - Color management operation screen (pp.45-46)
 - "No signal" for Power management (p.52)
 - P-TIMER (p.29)
 - "Please wait..."
 - Arrows for the True function in the Screen Menu (p.39)

Background

The selected background screen will be displayed when no input signal is detected.

- Blue . . . Blue colored background.
- User . . . The image you captured.
- Black . . . Black colored background.

SETTING MENU (Language)

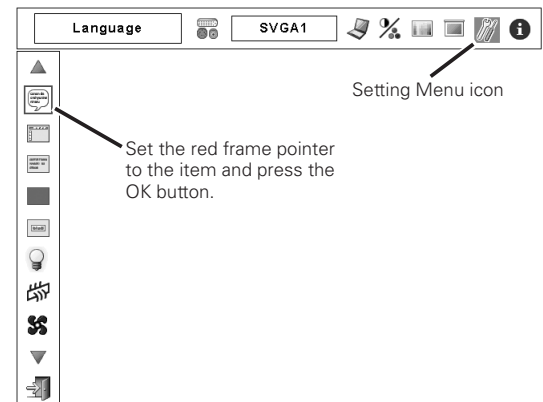

Press the OK button at Language, then the Language Menu appears.

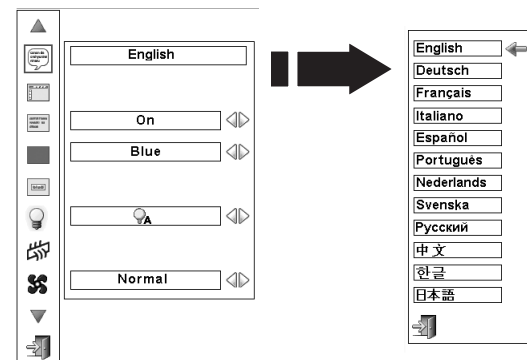

Menu

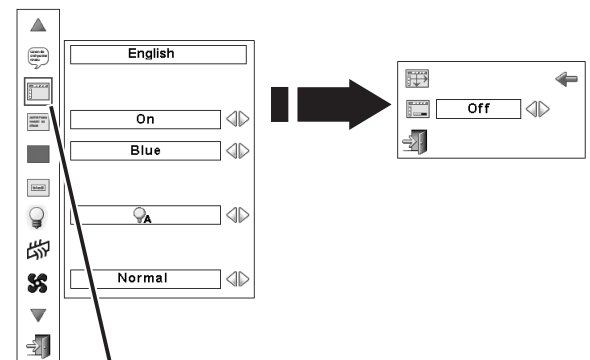

✓ Note:

- User cannot be selected when the image is not captured.



Logo

This function allows you to customize the screen logo with Logo select, Capture, and Logo PIN code lock functions.

✓ Note:

- When "On" is selected in the Logo PIN code lock function, Logo select and Capture functions cannot be selected.



Logo select

This function decides on the starting-up display from among the following options.

- User . . . Show the image you captured.
- Default . Show the factory-set logo.
- Off Show the countdown display only.



Capture

This function enables you to capture an image being projected to use it for a starting-up display or interval of presentations.

Select Capture and press the OK button.
A confirmation box appears and select [Yes] to capture the projected image.

After capturing the projected image, go to the Logo select function and set it to "User". Then the captured image will be displayed the next time you turn on the projector.

To cancel the Capture function, select [No].

✓ Note:

- Before capturing an image, select "Standard" in the Image Select Menu to capture a proper image (pp. 38, 42). Adjusted image on the screen cannot be captured.
- A signal from a computer can be captured up to XGA (1024 X 768).
- Certain signals may not be captured properly.
- When capturing the image that has been adjusted by the Keystone function, the adjusted data is automatically reset and the projector captures an image without keystone correction.
- When starting to capture a new image, the previously stored image is cleared even if you cancel the capturing.
- Once you exit the Logo Menu after setting the Logo lock to "On," you are required to enter the PIN code every attempting to change the Logo setting.
- User cannot be selected when the image is not captured.

Logo

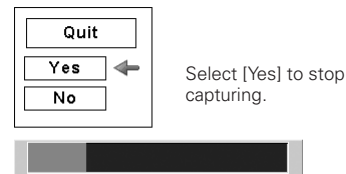
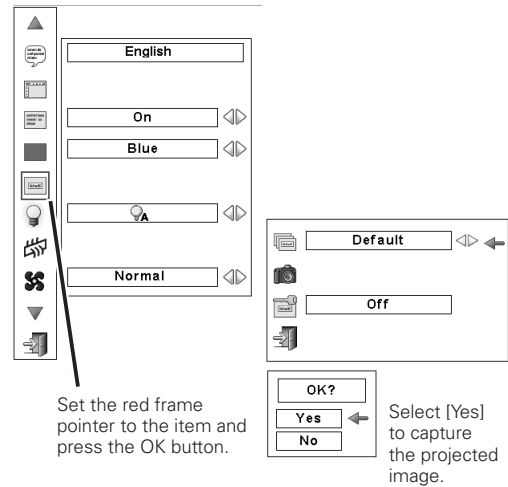

Capture

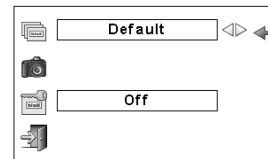



Logo PIN code lock

This function prevents an unauthorized person from changing the screen logo.

- Off The screen logo can be changed freely from the Logo Menu.
- On The screen logo cannot be changed without a Logo PIN code.

If you want to change the Logo PIN code lock setting, press the OK button and the Logo PIN code dialog box appears. Enter a Logo PIN code by following the steps below. The initial Logo PIN code is set to "4321" at the factory.

Enter a Logo PIN code

Use the Point ▲▼ buttons on the side control or Number buttons on the remote control unit to enter a number.

When using side control

Use the Point ▲▼ buttons on the side control to select a number. Press the Point ► button to fix the number and move the red frame pointer to the next box. The number changes to "*." Repeat this step to complete entering a four-digit number. After entering the four-digit number, move the pointer to "Set." Press the OK button so that you can change the Logo PIN code lock setting.

When using remote control unit

Press the Number buttons on the remote control unit to enter a number (p.14). When you complete entering a four-digit number, the pointer moves to "Set." Press the OK button so that you can change the Logo PIN code lock setting.

If you fixed an incorrect number, use the Point ◀ button to move the pointer to the number you want to correct, and then enter the correct number.

If you entered an incorrect PIN code, "Logo PIN code" and the number (****) will turn red for a moment. Enter the correct PIN code all over again.

Change the Logo PIN code lock setting

Use the Point ◀▶ buttons to switch On/Off, and then press the Point ▼ button to move the pointer to "Quit." Press the OK button to close the dialog box.

Change the Logo PIN code

Logo PIN code can be changed to your desired four-digit number. Press the Point ▼ button to select "Logo PIN code change" and then press the OK button. The New Logo PIN code input dialog box appears. Set a new Logo PIN code.

Be sure to note the new Logo PIN code and keep it at hand. If you lost the number, you could no longer change the Logo PIN code setting. For details on PIN code setting, refer to "PIN code lock" on pages 53–54.

Logo PIN Code Lock

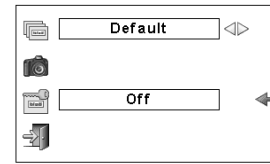

Enter a Logo PIN code

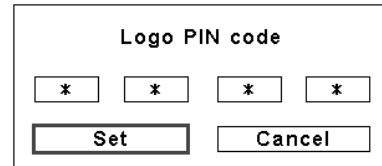

After a correct Logo PIN code is entered, the following dialog box appears.

Change the Logo PIN code lock setting



Use the Point ◀▶ buttons to switch On/Off,

Change the Logo PIN code

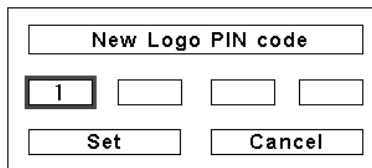

CAUTION:

WHEN YOU HAVE CHANGED THE LOGO PIN CODE, WRITE DOWN THE NEW PIN CODE IN COLUMN OF THE LOGO PIN CODE NO. MEMO ON PAGE 76, AND KEEP IT SECURELY. SHOULD THE LOGO PIN CODE BE LOST OR FORGOTTEN, THE LOGO PIN CODE SETTING CAN NO LONGER BE CHANGED.

NOTE:

If you forget your Logo PIN code and unable to change it, the Logo PIN code can be reset to the factory default setting (4321) according to the following procedures. When you reset the Logo PIN code, the PIN code and Key lock will be reset, as well.

1. Unplug the AC Power Cord from the AC outlet.
2. Hold down the OK button on the projector and connect the AC Power Cord into the outlet again. Keep holding down the OK button until the POWER indicator lights. The Logo PIN code returns to the factory default setting while the Logo PIN code lock state will remain the same as the previous set state.



Lamp mode

This function allows you to change the brightness of the screen.

- Auto mode Brightness according to the input signal.
- Normal mode Normal brightness.
- Eco 1 mode Lower brightness and Fan control set to Normal. Lower brightness reduces the lamp power consumption and extends the lamp life.
- Eco 2 mode Lower brightness and Fan control set to Max. Lower brightness reduces the lamp power consumption and extends the lamp life. It is recommended to use Eco 2 mode when using the projector continuously over a long period of time. The fan noise becomes louder in Eco 2 mode than in Eco 1 mode. Select the suitable mode for the used environment.



Filter control

You can replace the filter with this function. Press the OK button at Filter control to display a confirmation box. To replace, press the OK button at "YES" and the electrically operated filter starts to scroll.

You can also replace the filter by using the remote control unit (p. 29).

✓ Note:

- Filter replacement icon and "Please wait..." message appear on the screen when the filter is being scrolled.
- When the filter is replaced, the total accumulated time of the filter use is automatically set to 0.



Fan control

Choose the running speed of cooling fans from the following options.

- Normal..... Operate in this mode under normal conditions.
- Max Use this mode when you want to increase the cooling effect when operating the projector in high ambient temperature environment. Fan noise is louder than "Normal".



Remote control

The eight different remote control codes (Code 1–Code 8) are assigned to the projector; the factory-set, initial code (Code 1) and the other seven codes (Code 2 to Code 8).

The same code should set on both the projector and the remote control unit. For example, operating the projector in "Code 7", the remote control code also must be switched to "Code 7".

To change the code for the projector

Select a remote control code in this Setting Menu.

To change the code for the remote control unit:

Press and hold the MENU button and a number button (1–8) on the remote control unit for more than 5 seconds to switch between the codes (p. 16).



RC sensor

Select a location of the infrared remote receiver of the remote control unit. See "Remote Control Receivers and Operating Range" on page 15 for details.

- Both..... Activate both the front and back receiver.
- Front..... Activate only the front receiver.
- Back..... Activate only the back receiver.

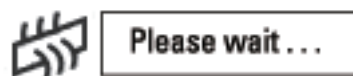

Remote control

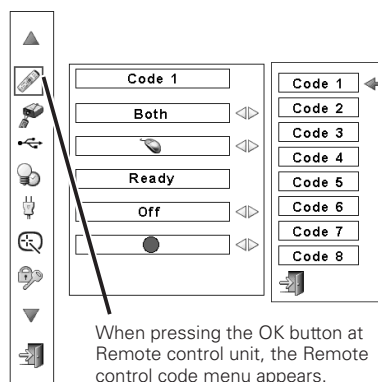

Setting



USB

The Projector has a USB port for interactive operation between the projector and computers. Set the mode by following the steps below.

Wireless Mouse mode

Select “” when controlling a computer with the remote control unit of this projector.

Projector mode:

“” Not used.



Power management

For reducing power consumption as well as maintaining the lamp life, the Power management function turns off the projection lamp when the projector is not used for a certain period.

If the input signal is interrupted and no button is pressed for more than 30 seconds, the timer display with “No signal” appears. It starts the countdown until the lamp is turned off. The countdown time can be set between 1 and 30 minutes.

Use the Point buttons to set the countdown timer.

Select one of the following options:

- Ready When the lamp has been fully cooled down, the POWER indicator starts blinking. In this condition, the projection lamp is turned on if the input signal is reconnected or any button on the side control or remote control unit is pressed .
- Shutdown When the lamp has been fully cooled down, the power is turned off.
- Off Power Management function is off.

✓ Note:

- Factory default is “Ready: 5 min.”



On start

When this function is set to “On,” the projector will be automatically turned on just by connecting the AC power cord to the wall outlet.

✓ Note:

- Be sure to turn off the projector properly (see “Turning Off the Projector” on page 24). If the projector is turned off in the incorrect sequence, the On start function does not work properly.



Pointer

You can emphasize a part of the projected image with this function. Use the Point buttons to select a pattern of the Pointer (Arrow, Cross, or Dot) (P. 30)

✓ Note:

- The Point buttons and OK button are invalid when the Pointer function is operating.

Power management



Time left before the lamp is off

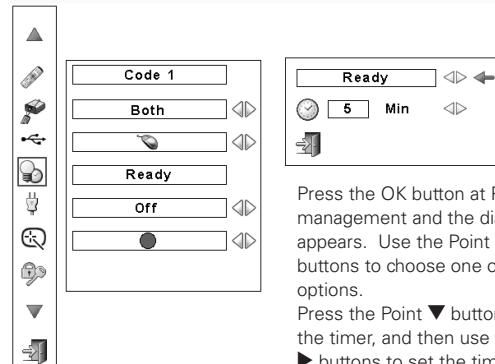

Press the OK button at Power management and the dialog box appears. Use the Point buttons to choose one of the three options. Press the Point button to select the timer, and then use the Point buttons to set the timer

 **Security**

 **Key lock**

This function locks the side control and remote control buttons to prevent operation by unauthorized persons.

 Unlocked.

 Lock the side control buttons.
To unlock, use the remote control unit.

 Lock the remote control buttons.
To unlock, use the side control.

If the side control accidentally becomes locked and you do not have the remote control unit nearby and unable to operate the projector, contact the service station.

 **PIN code lock**

This function prevents the projector from being operated by unauthorized persons and provides the following setting options for security.

- Off Unlocked.
- On1 Enter the PIN code every time turning on the projector.
- On2 Enter the PIN code to operate the projector once the power cord is disconnected; as long as the AC power cord is connected, the projector can be operated without a PIN code.

Whenever you change the PIN code lock setting or the PIN code (the four-digit number), you are required to enter the PIN code. "1234" is set as the initial PIN code at the factory.

If you want to change the PIN code lock setting, press the OK button and the PIN code dialog box appears. Enter a PIN code by following the steps on the next page.

Security

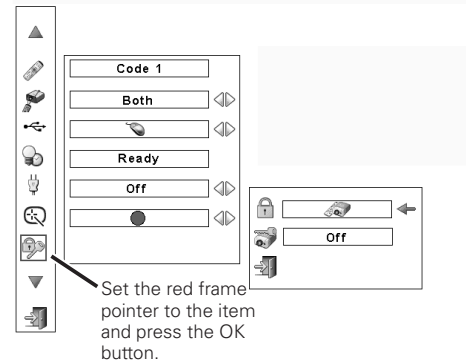

Key lock

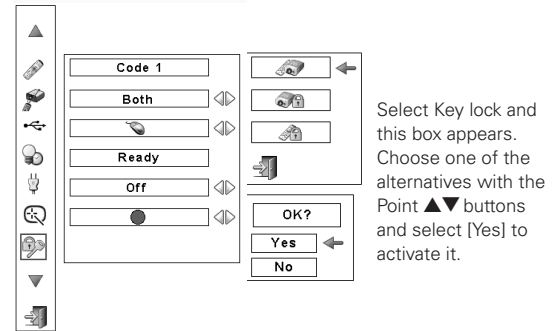

PIN code lock

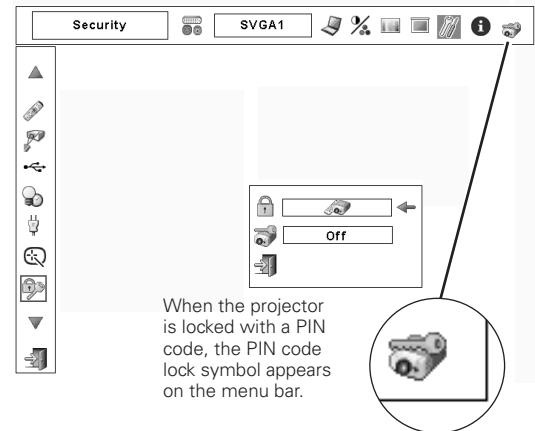

Enter a PIN code

Use the Point ▲▼ buttons on the side control or Number buttons on the remote control unit to enter a number.

When using side control

Use the Point ▲▼ buttons on the side control to select a number. Press the Point ► button to fix the number and move the red frame pointer to the next box. The number changes to “*.” Repeat this step to complete entering a four-digit number. After entering the four-digit number, move the pointer to “Set.” Press the OK button so that you can change the PIN code lock setting.

When using remote control unit

Press the Number buttons on the remote control unit to enter a number (p.14). When you complete entering a four-digit number, the pointer moves to “Set.” Press the OK button so that you can change the PIN code lock setting.

If you fixed an incorrect number, use the Point ◀ button to move the pointer to the number you want to correct, and then enter the correct number.

If you entered an incorrect PIN code, “PIN code” and the number (****) will turn red for a moment. Enter the correct PIN code all over again.

Change the PIN Code Lock setting

Use the Point ◀► button to select Off, On1, or On2 and then move the pointer to “Quit” with the Point ▼ button. Press the OK button to close the dialog box.

Change the PIN Code

The PIN code can be changed to your desired four-digit number. Press the Point ▼ buttons to select “PIN code change” and press the OK button. The New PIN code input dialog box appears. Set a new PIN code.

CAUTION:

WHEN YOU HAVE CHANGED THE PIN CODE, WRITE DOWN A NEW PIN CODE IN COLUMN OF THE PIN CODE NO. MEMO ON PAGE 76, AND KEEP IT SECURELY. IF YOU FORGET YOUR PIN CODE, THE PROJECTOR CAN NO LONGER BE STARTED.



Lamp counter

This function is used to reset the lamp counter.

When the lamp life reaches a recommended lamp replacement time, the time shown in the dialog box turns red and the Lamp replacement icon appears on the screen, indicating that the end of lamp life is approaching.

When replacing the projection lamp, reset the lamp counter. See “Resetting the Lamp Counter” on page 60.

✓ Note:

- The Lamp replacement icon will not appear when the Display function is set to “Off” (p.48), during “Freeze” (p.28), or “Blank” (p.29).

Enter a PIN code

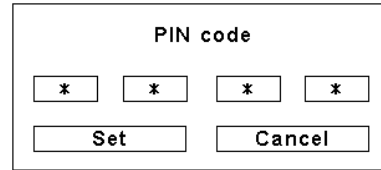

After a correct Logo PIN code is entered, the following dialog box appears.

Change the PIN code lock setting



Use the Point ◀► buttons to switch between the options.

Change the PIN code

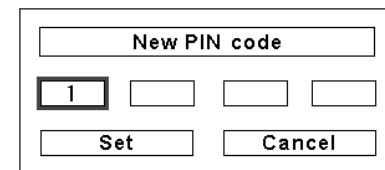

NOTE:

If you forget your PIN code and unable to change it, the PIN code can be reset to the factory default setting (1234) according to the following procedures. When you reset the PIN code, the Logo PIN code and Key lock will be reset, as well.

1. Unplug the AC Power Cord from the AC outlet.
2. Hold down the OK button on the projector and connect the AC Power Cord into the outlet again. Keep holding down the OK button until the POWER indicator lights. The PIN code returns to the factory default setting while the PIN code lock state will remain the same as the previous set state.



This icon appears on the screen when the end of lamp life is approaching.

✓ Note:

- This icon also appears at turning on and selecting input source.



Filter counter

This function is used to set a frequency for the filter replacement.

Use the Point ▲▼ buttons to move the red frame pointer to Filter counter and then press the OK button. A dialog box appears showing the Used time option and the Scrolls remaining option.

Used Time Show the total accumulated time of the filter use, timer setting option and the Reset options. When the projector reaches a time set in the timer setting, the Filter replacement icon (Fig. 1) appears on the screen and the total accumulated time turns red, indicating that the filter replacement is necessary. If the filter is out of scroll and the projector reaches a time set in the timer setting, Fig. 2 appears on the screen, indicating that the filter cartridge replacement is necessary.

Scrolls remaining . . Show the scroll counter and the Reset options. When the filter scroll is counted down to 1 (Scroll counter on the screen is showing "0 scroll(s)", the last scroll icon (Fig. 3) appears on the screen. When the filter scroll is counted down to 0, the Filter cartridge replacement icon (Fig. 4) appears on the screen and the WARNING FILTER indicator lights orange, indicating that the filter cartridge replacement is necessary.

To set a timer, press the OK button on Used time option. Move the red arrow pointer to the timer setting option and use the Point ◀▶ buttons to select from (Off/ 400H/700H/1000H) depending on the use environment.

When replacing the Filter cartridge, reset the Filter counter and the Scroll counter (p.58).

✓ Note:

- Do not reset the counter(s) when the filter or the filter cartridge are not replaced.
- Timer setting notifies that the filter needs replacement. To replace the filter, use the filter control function (p.51).



Test pattern

Various test pattern are available for use when setting up the projector.



Factory default

This function returns all setting values except for the user logo, PIN code lock, Logo PIN code lock, lamp counter, and filter counter to the factory default settings.



Quit

Exit the Setting Menu.

Filter counter



Set the red frame pointer to the item and press the OK button.

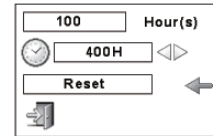
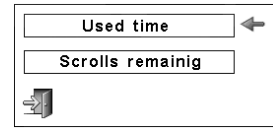

Use the Point ◀▶ buttons to set the timer. Select from (Off/ 400H/700H/1000H) depending on the use environment.

Fig.1 Filter replacement icon



Filter replacement icon appears on the screen at a set time.

Fig.2



Fig.3 Last scroll icon



Last scroll icon appears on the screen when the filter is down to the last scroll.

Fig.4 Filter cartridge replacement icon



Filter cartridge replacement icon appears on the screen when the filter scroll is counted down to 0 scroll.

✓ Note:

- Fig.1, Fig. 2, Fig. 3 and Fig. 4 appear at turning on and selecting input source.
- Fig.1, Fig. 2, Fig. 3 and Fig. 4 will not appear when the Display function is set to "Off" (p.48), during "Freeze" (p.28), or "Blank" (p.29).

Factory default

Set the red frame pointer to the item and press the OK button.

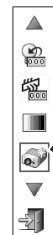

Select Factory default and this box appears. Select [Yes], and the next box appears.

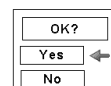
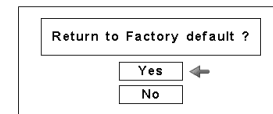

Select [Yes] to activate it.

Maintenance and Care

Filter Instructions

Filter prevents dust from accumulating on the optical elements inside the projector. Should the filter becomes clogged with dust particles, it will reduce cooling fans' effectiveness and may result in internal heat buildup and adversely affect the life of the projector. This projector has an electrically operated filter which helps you to replace the filter easily. The projector monitors the condition of the filter at all time and replaces a filter with a new one automatically when it detects the clogging.

If the projector reaches a time set in the timer setting (p. 55), a Filter replacement icon (Fig.1) appears on the screen and the WARNING FILTER indicator on the top panel lights up (p.70). When you see this icon, replace the filter as soon as possible (pp.29, 51). If the filter is out of scroll and the projector reaches a time set in the timer setting, Fig. 2 appears on the screen, indicating that the filter cartridge replacement is necessary.

When the filter scroll is counted down to 1, the Last scroll icon (Fig.3) appears on the screen, indicating that there is one scroll left in the filter cartridge (p.55).

If the projector detects that the filter is clogged and no scroll is left in the filter cartridge, a Filter cartridge replacement icon (Fig. 4) appears on the screen and the WARNING FILTER indicator on the top panel lights up (p.70). When you see this icon, replace the filter cartridge (p.57) and reset the Filter counter (p.58) and the Scroll counter (p.58).

When the filter is being scrolled using the remote control unit (p.29) or the Filter control function in the setting menu (p.51), a Filter replacement icon and "Please wait..." message (Fig.5) appear on the screen and the WARNING FILTER indicator blinks slow (approx. 2 seconds ON, 2 seconds OFF) (p.69).

The WARNING FILTER indicator blinks fast when the projector detects an abnormal condition, the filter cartridge is not installed properly, or the filter scroll is not working properly (p.70).

✓ Note:

- Fig.1, Fig.2, Fig.3, Fig. 4 and Fig.5 will not appear when the Display function is set to "Off" (p.48), during "Freeze" (p.28), or "Blank" (p.29).
- The filter cannot be rewinded.
- The filter can be scrolled 9 times since the filter cartridge has 10 scrolls.
- The filter cartridge is disposable. Do not clean and reuse the filter cartridge.
- Do not expose the filter cartridge to water or liquid, or it may cause a breakdown.
- Replace the filter cartridge after all the scroll is used up. If you replace the filter cartridge when there are some scrolls left in the filter cartridge, the filter counter and the scroll counter do not recognize the correct number of remaining scrolls and the reset function cannot work properly. It may cause a breakdown.
- Do not use the filter cartridge with other projector. The filter counter and the scroll counter do not recognize the correct number of remaining scrolls of the used filter cartridge and the reset function cannot work properly. It may cause a breakdown.
- Make sure that the projection lamp is turn off when you are replacing the filter cartridge. If you replace the filter cartridge when the projection lamp is turn on, the projector will be shut down automatically for safety purpose
- When you forget to reset the filter counter, the projector cannot recognize the correct number of remaining scrolls and may cause a breakdown.
- Do not forget to reset the filter counter and the scroll counter in the setting menu after replacing the filter cartridge. If you forget to reset the filter counter and the scroll counter, the projector cannot recognize the correct number of remaining scrolls and may cause a breakdown.



Fig.1 Filter replacement icon



Fig.2



Fig.3 Last scroll icon



Fig.4 Filter cartridge replacement icon

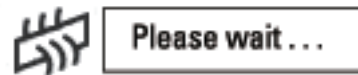

Fig.5 Filter replacement icon and "Please wait..." message.

Replacing the Filter Cartridge

- 1** Turn off the projector, and unplug the AC power cord from the AC outlet.
- 2** First, clean up the dust on the projector and around the air vents.
- 3** Press ▲ on the filter cover to release the latch and open the filter cover.
- 4** Pull out the filter cartridge. When taking out the filter cartridge, put your finger on the filter cartridge's tab and then pull.
- 5** Put the new one back into the position and close the filter cover. Make sure that the filter cartridge is properly and fully inserted.
- 6** Connect the AC power cord to the projector and turn on the projector.
- 7** **Reset the filter counter and the scroll counter** (p.58).



CAUTION

Make sure the filter cartridge is inserted in the projector. If the filter cartridge is not inserted, the projector cannot be turned on.
Do not put anything into the air vents. Doing so may result in malfunction of the projector.

RECOMMENDATION

We recommend avoiding dusty/smoky environments when operating the projector. Usage in these environments may cause a poor image quality.

When using the projector under dusty or smoky conditions, dust may accumulate on a lens, liquid crystal panels, or optical elements inside the projector. Such condition may degrade the quality of the projected image.

When the symptoms above are noticed, contact your authorized dealer or service station for proper cleaning.

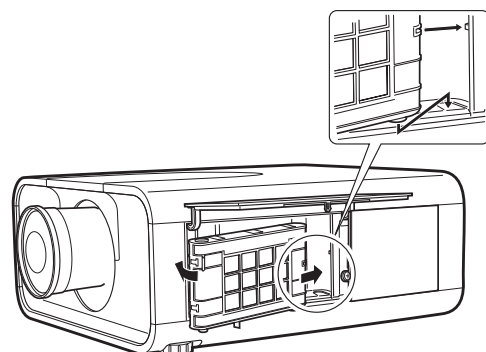
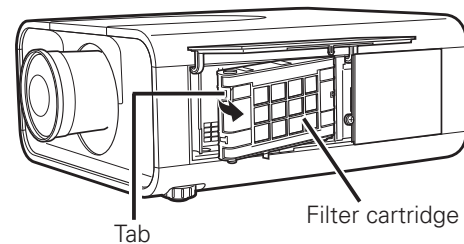
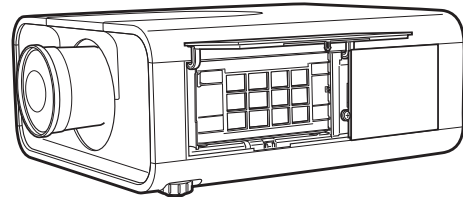
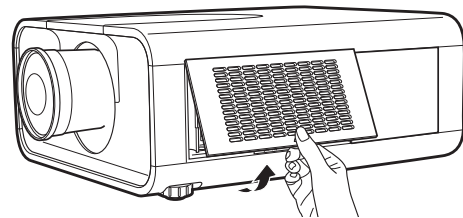
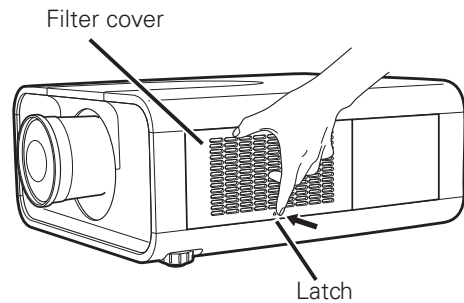

Resetting the Filter Counter

Be sure to reset the Filter counter after replacing the filter cartridge.

- 1** Press the MENU button to display the On-Screen Menu. Use the Point ◀▶ buttons to move the red frame pointer to the Setting Menu icon.
- 2** Use the Point ▲▼ buttons to move the red frame pointer to Filter counter and then press the OK button. A dialog box appears showing the Used time option and the Scrolls remaining option. Use the Point ▲▼ buttons to select Used time.
- 3** Used time shows the total accumulated time of the filter use, a timer setting option, and the Reset option. Select Reset and the "Filter counter Reset?" appears. Select [Yes] to continue.
- 4** Another confirmation dialog box appears, select [Yes] to reset the Filter counter.

Filter counter

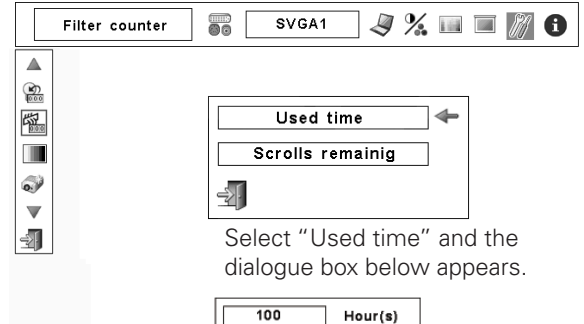

Select "Used time" and the dialogue box below appears.

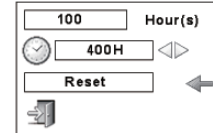

Select Reset and the "Filter counter Reset?" appears.

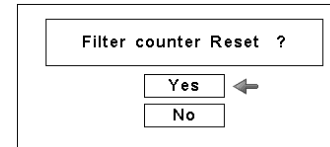

Select [Yes], then another confirmation box appears.

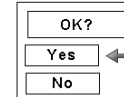

Select [Yes] again to reset the Filter counter.

Resetting the Scroll Counter

Be sure to reset the Scroll counter after replacing the filter cartridge.

- 1** Press the MENU button to display the On-Screen Menu. Use the Point ◀▶ buttons to move the red frame pointer to the Setting Menu icon.
- 2** Use the Point ▲▼ buttons to move the red frame pointer to Filter counter and then press the OK button. A dialog box appears showing the Used time option and the Scrolls remaining option. Use the Point ▲▼ buttons to select Scroll(s) remaining.
- 3** Scroll(s) remaining shows the number of the remaining scrolls and the Reset option. Select Reset and the "Scroll counter Reset?" appears. Select [Yes] to continue.
- 4** Another confirmation dialog box appears, select [Yes] to reset the Scroll counter.

Scroll counter

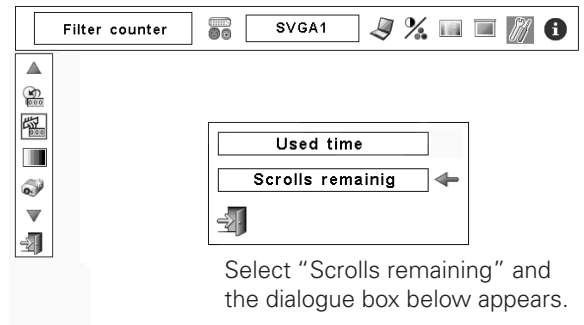

Select "Scrolls remaining" and the dialogue box below appears.

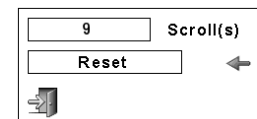

Select Reset and the "Scroll counter Reset?" appears.

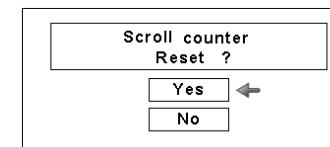

Select [Yes], then another confirmation box appears.

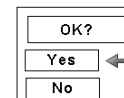

Select [Yes] again to reset the Scroll counter.

Lamp Replacement

When the projection lamp of the projector reaches its end of life, the Lamp replacement icon appears on the screen and LAMP REPLACE indicator lights orange. Replace the lamp with a new one promptly. The timing when the LAMP REPLACE indicator should light is depending on the lamp mode.

Top Panel

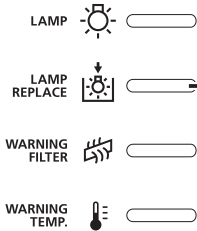

LAMP REPLACE indicator



Lamp replacement icon

✓ **Note:**

- The Lamp replacement icon will not appear when the Display function is set to "Off" (p.48), during "Freeze" (p.28), or "Blank" (p.29).

Follow these steps to replace the lamp.

- 1 Turn off the projector and unplug the AC power cord. Let the projector cool for at least 45 minutes.
- 2 Open the filter cover. (p.57)
- 3 Loosen the screw and open the lamp cover. Pull out the lamp by using the built in handle.
- 4 Replace the lamp with a new one. Make sure that the lamp is properly and fully inserted.
- 5 Close the lamp cover and secure the screw.
- 6 Close the filter cover.
- 7 Connect the AC power cord to the projector and turn on the projector.
- 8 **Reset the Lamp counter** (p.60)

✓ **Note:**

- Be sure to insert the lamp in the correct direction.
- Do not reset the Lamp counter when the projection lamp is not replaced.

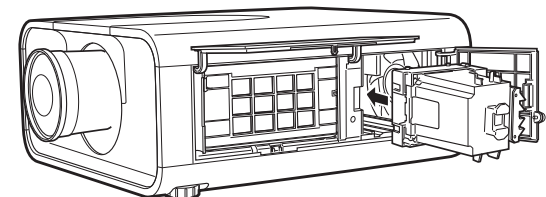
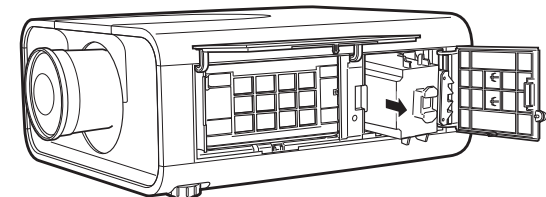
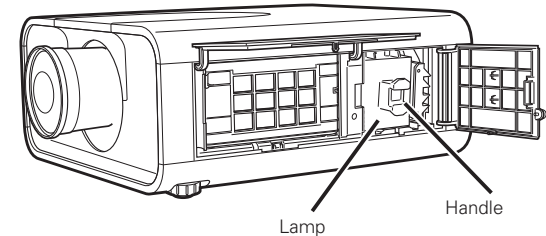
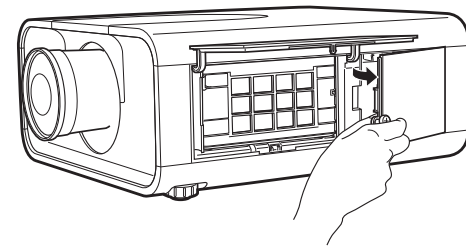
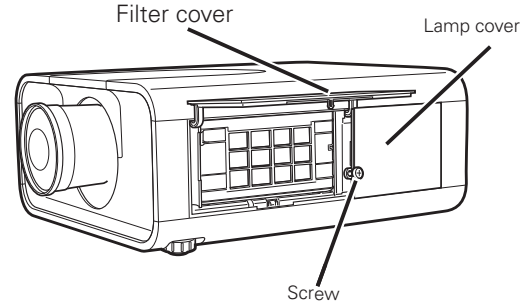

CAUTION

Allow a projector to cool for at least 45 minutes before you open the lamp cover. The inside of the projector can become very hot.



CAUTION

For continued safety, replace with a lamp of the same type. Do not drop the lamp or touch the glass bulb! The glass can shatter and may cause injury.

Resetting the Lamp Counter

Be sure to reset the Lamp counter after the lamp is replaced. When the Lamp counter is reset, the LAMP REPLACE indicator stops lighting and the Lamp replacement icon disappears.

- 1 Press the MENU button to display the On-Screen Menu. Use the Point ◀▶ buttons to move the red frame pointer to the Setting Menu icon
- 2 Use the Point ▲▼ buttons to move the red frame pointer to Lamp counter and then press the OK button. A dialog box appears showing the total accumulated time of the lamp usage and the reset option. Select Reset and the "Lamp replacement counter Reset?" appears. Select [Yes] to continue.
- 3 Another confirmation dialog box appears and select [Yes] to reset the Lamp counter.

✓ **Note:**

- Do not reset the Lamp counter without replacing the lamp. Be sure to reset the Lamp counter only after replacing the lamp.

Lamp counter

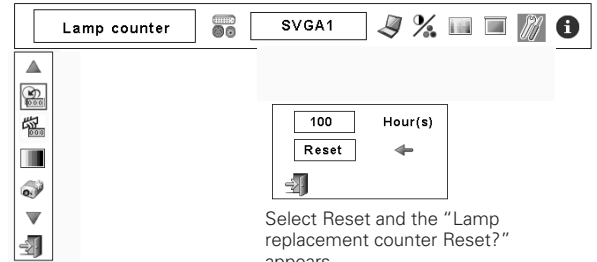

Select Reset and the "Lamp replacement counter Reset?" appears.

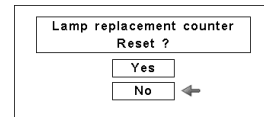

Select [Yes], then another confirmation box appears.

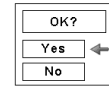

Select [Yes] again to reset the lamp counter.

ORDER REPLACEMENT LAMP

Replacement lamp can be ordered through your dealer. When ordering, give the following information to the dealer.

- **Model No. of your projector** : **LV-7585**
- **Replacement Lamp Type No.** : **LV-LP29**



LAMP HANDLING PRECAUTIONS

This projector uses a high-pressure lamp which must be handled carefully and properly. Improper handling may result in accidents, injury, or create a fire hazard.

- Lamp lifetime may differ from lamp to lamp and according to the environment of use. There is no guarantee of the same lifetime for each lamp. Some lamps may fail or terminate their lifetime in a shorter period of time than other similar lamps.
- If the projector indicates that the lamp should be replaced, i.e., if the LAMP REPLACE indicator lights up, replace the lamp with a new one IMMEDIATELY after the projector has cooled down. (Follow carefully the instructions in the Lamp Replacement section of this manual.) Continuous use of the lamp with the LAMP REPLACE indicator lighted may increase the risk of lamp explosion.
- Lamp may explode as a result of vibration, shock or degradation as a result of hours of use as its lifetime draws to an end. Risk of explosion may differ according to the environment or conditions in which the projector and lamp are being used.

IF A LAMP EXPLODES, THE FOLLOWING SAFETY PRECAUTIONS SHOULD BE TAKEN.

If a lamp explodes, disconnect the projector's AC plug from the AC outlet immediately. Contact an authorized service station for a checkup of the unit and replacement of the lamp. Additionally, check carefully to ensure that there are no broken shards or pieces of glass around the projector or coming out from the cooling air circulation holes. Any broken shards found should be cleaned up carefully. No one should check the inside of the projector except those who are authorized trained technicians and who are familiar with projector service. Inappropriate attempts to service the unit by anyone, especially those who are not appropriately trained to do so, may result in an accident or injury caused by pieces of broken glass.

Cleaning the Projection Lens

Unplug the AC power cord before cleaning.

Gently wipe the projection lens with a cleaning cloth that contains a small amount of non-abrasive camera lens cleaner, or use a lens cleaning paper or commercially available air blower to clean the lens.

Avoid using an excessive amount of cleaner. Abrasive cleaners, solvents, or other harsh chemicals might scratch the surface of the lens.

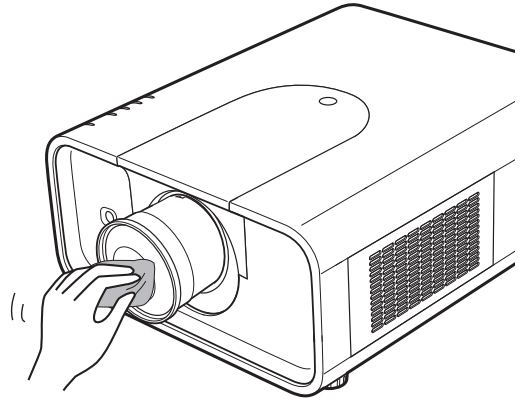

Cleaning the Projector Cabinet

Unplug the AC power cord before cleaning.

Gently wipe the projector body with a soft dry cleaning cloth. When the cabinet is heavily soiled, use a small amount of mild detergent and finish with a soft dry cleaning cloth. Avoid using an excessive amount of cleaner. Abrasive cleaners, solvents, or other harsh chemicals might scratch the surface of the cabinet.

When the projector is not in use, put the projector in an appropriate carrying case to protect it from dust and scratches.

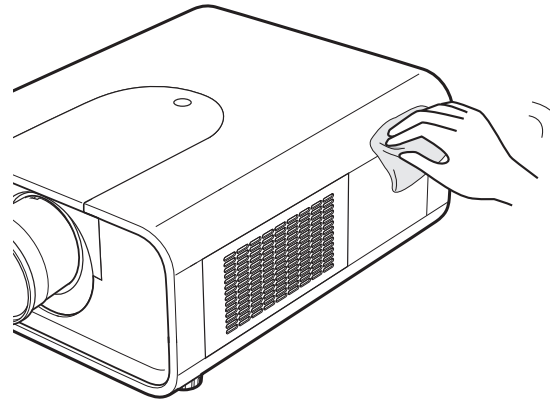

Warning Indicators

The WARNING indicators show the state of the function which protects the projector. Check the state of the WARNING indicators and the POWER indicator to take proper maintenance.

The projector is shut down and the WARNING TEMP. indicator is blinking red.

When the temperature inside the projector reaches a certain level, the projector will be automatically shut down to protect the inside of the projector. The LAMP indicator turns red and the WARNING TEMP indicator blinks while the projector is being cooled down. When the projector has cooled down enough (to its normal operating temperature), it can be turned on again by pressing the POWER button.

✓ Note:

- The WARNING TEMP. indicator continues to blink even after the temperature inside the projector returns to normal. When the projector is turned on again, the WARNING TEMP. indicator stops blinking.

Then check the matters below:

- Did you provide appropriate space for the projector to be ventilated? Check the installing condition to see if the air vents of the projector are not blocked.
- Has the projector been installed near an Air-Conditioning/ Heating Duct or Vent? Move the installation of the projector away from the duct or vent.
- Is the filter clean? Replace the filter with a new one.

The projector is shut down; and the LAMP indicator is lighting and other four indicators are blinking.

When the projector detects an abnormal condition, it will be automatically shut down to protect the inside of the projector and the LAMP indicator lights on and other four indicators blink. In this case, unplug the AC power cord and plug it, and then turn on the projector once again to verify operation. If the projector cannot be turned on and these indicators are still lighting and blinking, unplug the AC power cord and contact the service station.



CAUTION

DO NOT LEAVE THE PROJECTOR WITH THE AC POWER CORD CONNECTED UNDER AN ABNORMAL CONDITION. IT MAY RESULT IN FIRE OR ELECTRIC SHOCK.

Top Panel

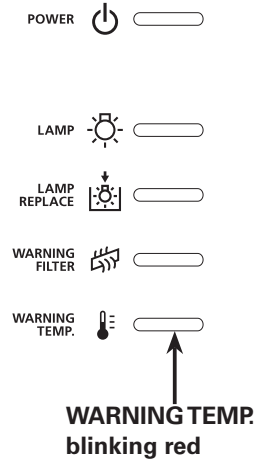

Top Panel

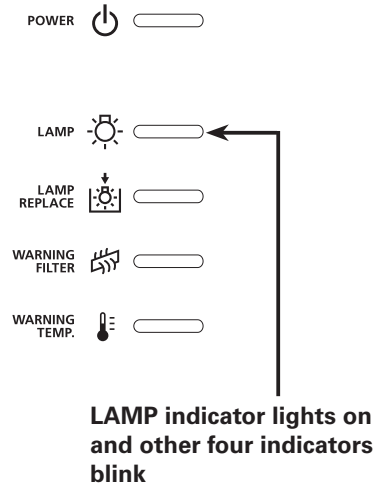





Appendix

Troubleshooting

Before calling your dealer or service center for assistance, check the items below once again.

1. Make sure you have properly connected the projector to peripheral equipment as described on pages 20–21.
2. Check the cable connection. Make sure that all computers, video equipment, and power cords are properly connected.
3. Make sure that all power is switched on.
4. If the projector still does not produce an image, restart your computer.
5. If an image still does not appear, disconnect the projector from your computer and check your computer monitor's display. A problem may be noticed with your graphics controller rather than with the projector. (When you reconnect the projector, be sure to turn the computer and monitor off before you turn on the projector. Turn on equipment in the order of the projector and computer.)
6. If a problem still persists, check the following solutions.

Problem:	Try These Solutions
No power.	<ul style="list-style-type: none"> ● Plug the power cord of the projector into the AC outlet. ● Wait until the POWER indicator stops blinking to turn on the projector again. (See page 23) ● Check the WARNING TEMP. indicator. If the WARNING TEMP. indicator is blinking, the projector cannot be turned on. (See page 63.) ● Check the projection lamp. (See page 59.) ● Unlock the Key lock function for the projector. (See page 53) ● See if the filter cartridge is inserted. (See page 57)
Image is out of focus.	<ul style="list-style-type: none"> ● Adjust the focus of the projector. ● Make sure the projection screen is at least 4.6' (1.4 m) away from the projector. ● Check the projection lens to see if it needs cleaning. <p>NOTE: Moving the projector from a cool to a warm place may result in moisture condensation on the projection lens. If this happens, leave the projector off and wait until condensation evaporates.</p>
Picture is left/right reversed.	<ul style="list-style-type: none"> ● Check the Ceiling/Rear function. (See pages 40, 44)
Picture is top/bottom reversed.	<ul style="list-style-type: none"> ● Check the Ceiling function. (See pages 40, 44.)
Some displays are not seen during operations.	<ul style="list-style-type: none"> ● Check the Display function. (See page 48.)
No image.	<ul style="list-style-type: none"> ● Check the connection between your computer or video equipment and the projector. ● It takes about 30 seconds to display an image after turning on the projector. ● See if the selected system is corresponding with your computer or video equipment. ● Make sure the temperature is not out of specified operating temperature (41°F–104°F [5°C–40°C]).
 appears on the screen	<ul style="list-style-type: none"> ● The end of lamp life is approaching. Replace the lamp with a new one promptly. (See page 59)
  appears on the screen	<ul style="list-style-type: none"> ● The filter is out of scroll. Replace the filter cartridge with a new one promptly. (See pages 56-57)

Problem:	Try These Solutions
Remote control unit does not work.	<ul style="list-style-type: none"> ● Check the batteries. ● Check if the ALL-OFF switch on the remote control unit is set to "ON." ● Check if the RC sensor is set properly. (See page 51) ● Make sure no obstruction is between the projector and the remote control unit. ● Make sure you are not too far from the projector when using the remote control unit. Maximum operating range is 16.4' (5 m). ● Make sure that the remote control code conforms to the projector's code. (See page 51.) ● Unlock the Key lock function for the remote control unit. (See page 53). ● Wireless remote control unit does not work when the remote control cable is connected to the projector. (See page 15).
Wireless mouse function does not work.	<ul style="list-style-type: none"> ● Check the cable connection between the projector and your computer. ● Check the mouse setting on your computer. ● Turn on the projector before you turn on the computer.
Unable to unlock the Logo PIN code lock, Security key lock or Security PIN code lock.	<ul style="list-style-type: none"> ● Contact the service station.
 <p>appears on the screen</p>	<ul style="list-style-type: none"> ● Your operation is invalid. Operate correctly.

WARNING:

High voltages are used to operate this projector. Do not attempt to open the cabinet.

If problems still persist after following all operating instructions, contact the dealer where you purchased the projector or the service center. Specify the model number and explain about the problem. We will advise you how to obtain service.

Menu Tree

Computer Input/Video Input

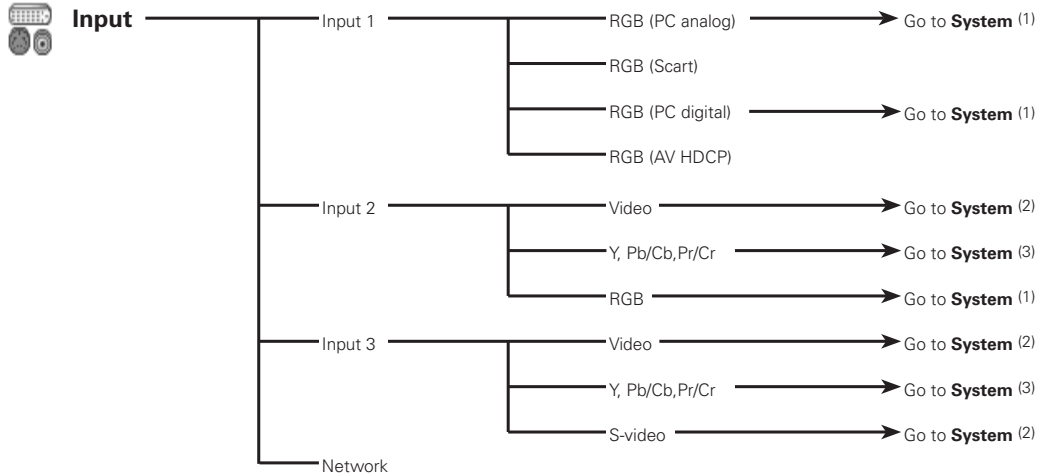

Information

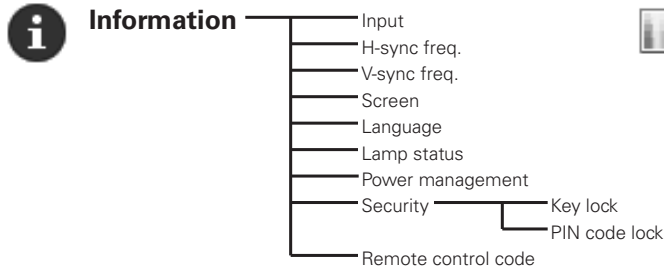
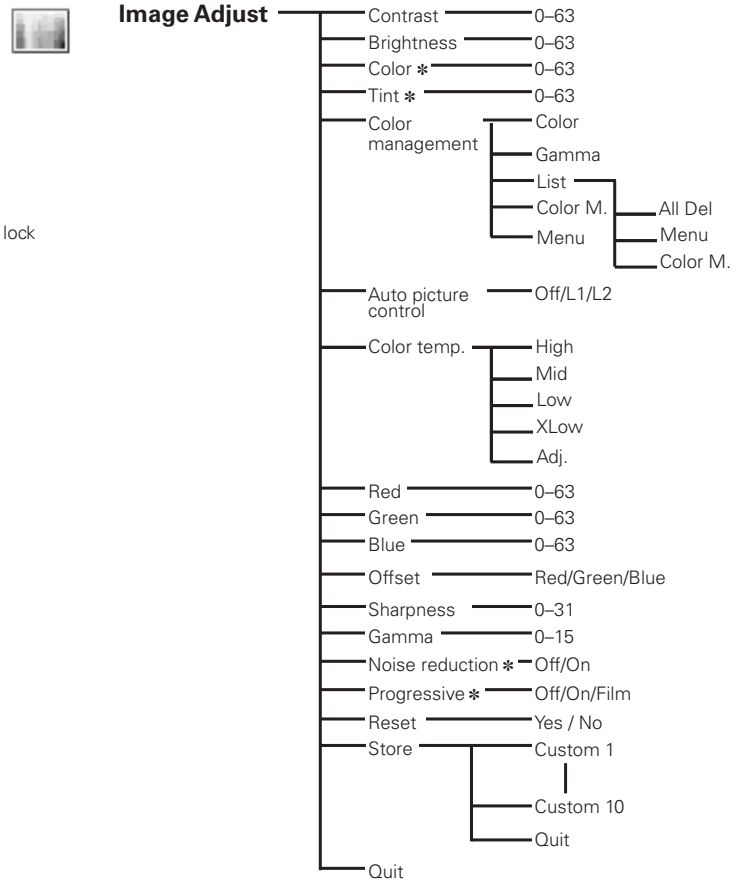

Image Adjust



* Displayed only in Video Input

✓ Note:

- The Menu display varies depending on the input signal.

Computer Input

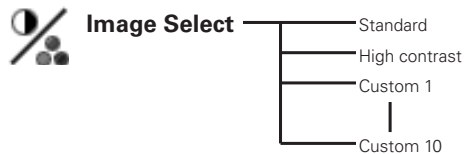
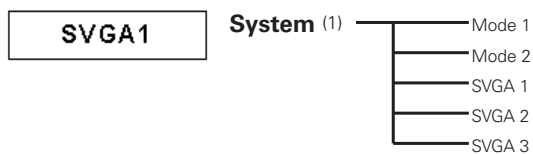

* System displayed in the System Menu varies depending on the input signal.

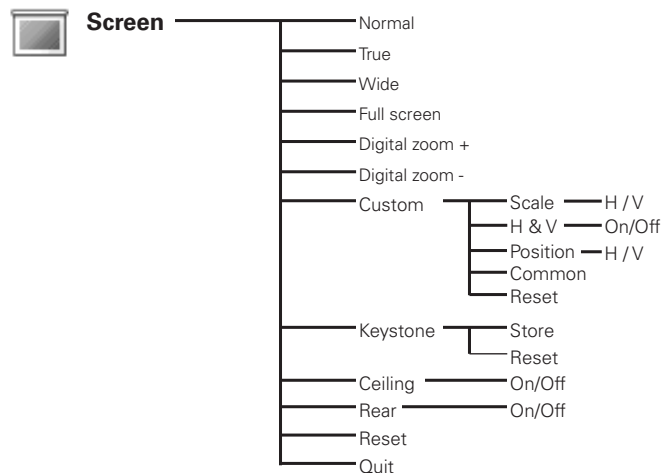
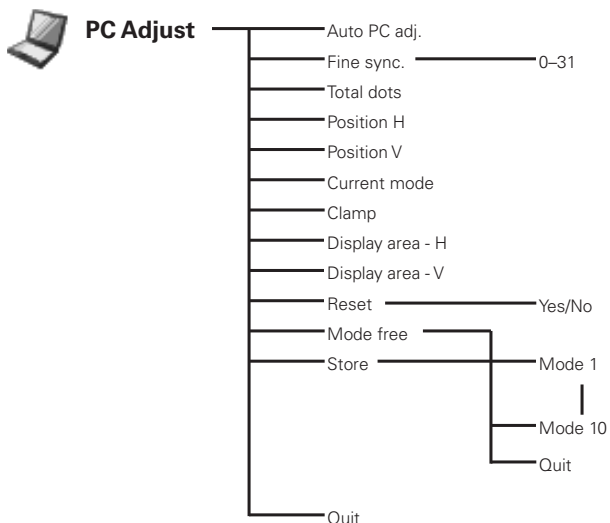

Video Input

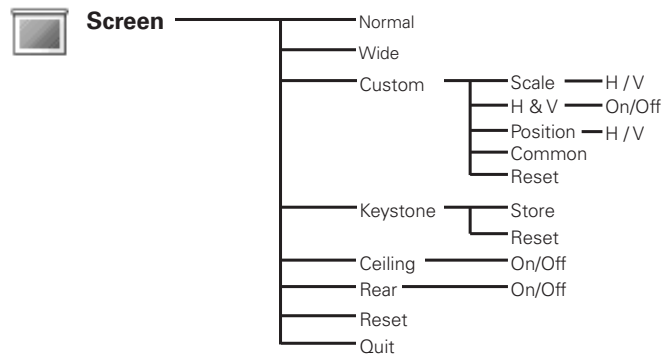
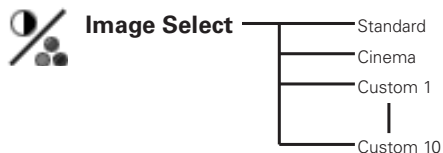
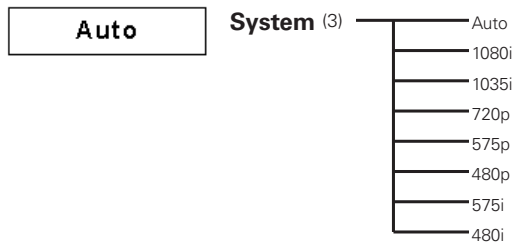
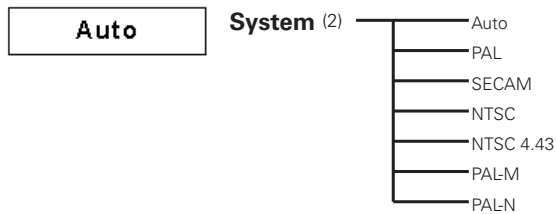

✓ Note:

• The Menu display varies depending on the input signal.

Computer Input/Video Input



Setting

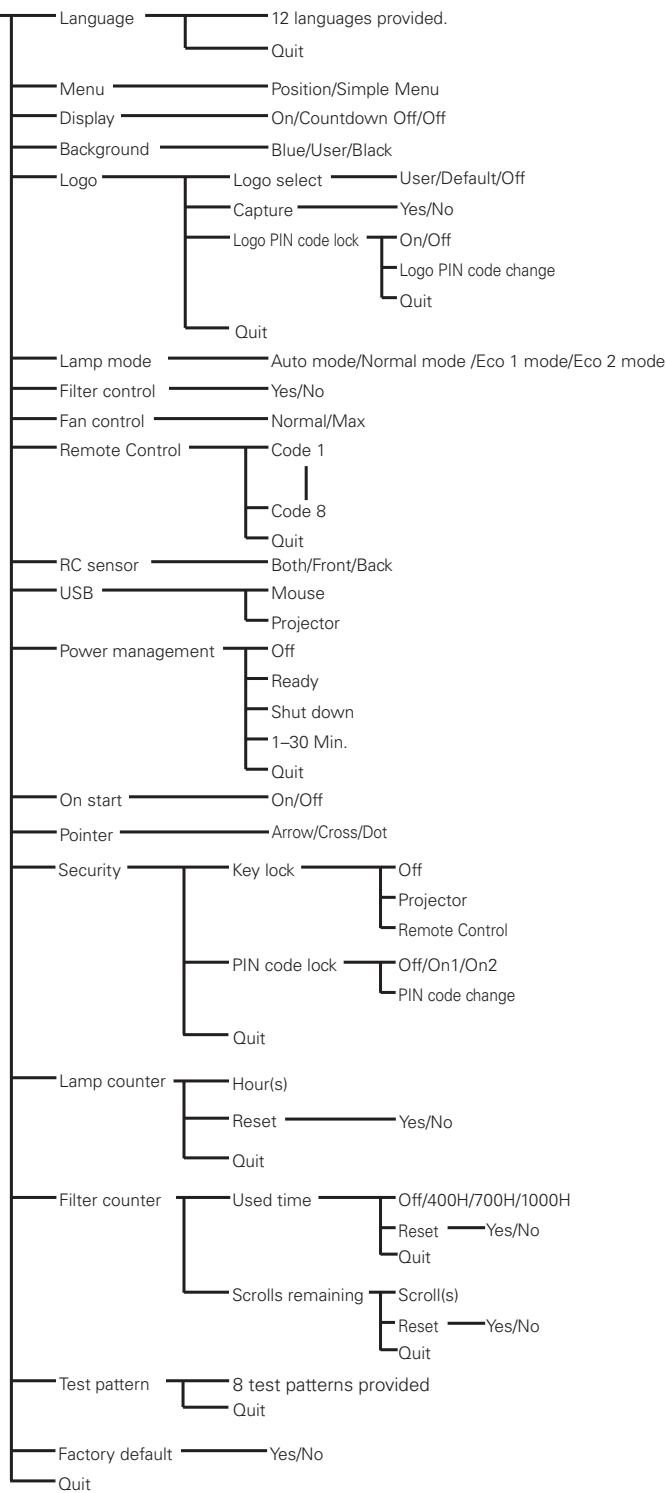

Indicators and Projector Condition

Check the indicators for the projector condition.

The projector is operating normally.

Indicators					Projector Condition
POWER green	LAMP red	WARNING TEMP red	WARNING FILTER orange	LAMP REPLACE orange	
●	●	●	*	❖	The projector is off. (The AC power cord is unplugged.)
○	○	●	*	❖	The projector is in stand-by mode. Press the POWER button to turn on the projector.
○	●	●	*	❖	The projector is operating normally.
●	○	●	*	❖	The projector is preparing for stand-by or the projection lamp is being cooled down. The projector cannot be turned on until cooling is completed and the POWER indicator lights green.
⦿	●	●	*	❖	The projector is in the Power management mode.
○	○	●	⦿	❖	The filter is scrolled using the FILTER button on the remote control unit or the Filter control function in the setting menu. When the filter is being scrolled, the Filter replacement icon and "Please wait..." message (Fig. 1) appear on the screen for 10 seconds.
					

Fig.1 Filter replacement icon and "Please wait..."

The projector is detecting abnormal condition.

Indicators					Projector Condition
POWER green	LAMP red	WARNING TEMP red	WARNING FILTER orange	LAMP REPLACE orange	
○	●	⦿	*	❖	The temperature inside the projector is elevated close to the abnormally high level.
●	○	⦿	*	❖	The temperature inside the projector is abnormally high. The projector cannot be turned on. When the projector is cooled down enough and the temperature returns to normal, the POWER indicator lights green and the projector can be turned on. (The WARNING TEMP. indicator keeps blinking.) Check and replace the filter.

○ ●●● on

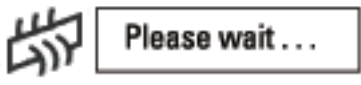
● ●●● dim

● ●●● off

⦿ ●●● blinking at the normal rate
(approx. 1 second ON,
1 second OFF)

⦿ ●●● blinking fast
(approx. 0.5 seconds ON,
0.5 seconds OFF)

⦿ ●●● blinking slow
(approx. 2 seconds ON,
2 seconds OFF)

Indicators					Projector Condition
POWER green	LAMP red	WARNING TEMP. red	WARNING FILTER orange	LAMP REPLACE orange	
○	○		*	❖	The projector has been cooled down enough and the temperature returns to normal. When turning on the projector, the WARNING TEMP. indicator stops blinking. Check and replace the filter.
●	○	●	*		The lamp cannot light up. (The projector is preparing for stand-by or the projection lamp is being cooled down. The projector cannot be turned on until cooling is completed.)
○	○	●	*		The lamp cannot light up. (The lamp has been cooled down enough and the projector is in stand-by mode and ready to be turned on with the POWER button.)
○	○	●	*	○	The lamp has been used overtime. Replace the lamp immediately and then reset the lamp counter. The indicator will be turned off after resetting the counter.
○	○	●	○	❖	If the Filter counter reached a time set in the timer setting, a Filter replacement icon (Fig.2) appears on the screen and the WARNING FILTER indicator on the top panel lights up. Replace the filter as soon as possible. If the filter is out of scroll and the projector reaches a time set in the timer setting, Fig. 3 appears on the screen and the WARNING FILTER indicator lights up. Replace the filter cartridge as soon as possible.
 Fig.2 Filter replacement icon Fig.3 Fig.4 Filter cartridge replacement icon					If the filter is clogged and no scroll is left in the filter cartridge, a Filter cartridge replacement icon (Fig.4) appears on the screen and the WARNING FILTER indicator lights up. Replace the filter cartridge as soon as possible. ✓ Note: • Fig.2, Fig.3 and Fig.4 icon will not appear when the Display function is set to "Off" (p.48), during "Freeze" (p.28), or "Blank" (p.29).
	○				The filter cartridge is not installed in the projector. Check the filter compartment to see if the filter cartridge is installed in the projector. When the filter cartridge is installed and the indicators continue to light and blink, read the column below. The projector detects an abnormal condition and cannot be turned on. Unplug the AC power cord and plug it again to turn on the projector. If the projector is turned off again, unplug the AC power cord and contact the dealer or the service center. Do not leave the projector on. It may cause an electric shock or a fire hazard.

- * When the filter detects clogging, reaches a time set in the timer setting or runs out of the filter scroll, the WARNING FILTER indicator lights orange. When this indicator lights orange, replace the filter or the filter cartridge with a new one promptly. Reset the Filter counter and Scroll counter after replacing the filter cartridge (p.58).
When the projection lamp reaches its end of life, the LAMP REPLACE indicator lights orange. When this indicator lights
- ❖ orange, replace the projection lamp with a new one promptly. Reset the lamp counter after replacing the lamp (p.59).

Compatible Computer Specifications

Basically this projector can accept the signal from all computers with the V- and H-Frequency mentioned below and less than 180 MHz of Dot Clock.

PC Adjustment is limited when selecting these modes.

ON-SCREEN DISPLAY	RESOLUTION	H-Freq. (kHz)	V-Freq.(Hz)	ON-SCREEN DISPLAY	RESOLUTION	H-Freq. (kHz)	V-Freq.(Hz)
VGA 1	640x480	31.470	59.880	SXGA 4	1400x1050	64.030	60.010
VGA 2	720x400	31.470	70.090	SXGA 5	1400x1050	62.500	58.600
VGA 3	640x400	31.470	70.090	SXGA 6	1280x1024	71.690	67.190
VGA 4	640x480	37.860	74.380	SXGA 7	1280x1024	81.130	76.107
VGA 5	640x480	37.860	72.810	SXGA 8	1280x1024	63.980	60.020
VGA 6	640x480	37.500	75.000	SXGA 9	1280x1024	79.976	75.025
VGA 7	640x480	43.269	85.000	SXGA 10	1280x960	60.000	60.000
MAC LC13	640x480	34.970	66.600	SXGA 11	1152x900	61.200	65.200
MAC 13	640x480	35.000	66.670	SXGA 12	1152x900	71.400	75.600
480p	640x480	31.470	59.880	SXGA 13	1280x1024 (Interlace)	50.000	86.000
575p	768x575	31.250	50.000	SXGA 14	1280x1024 (Interlace)	50.000	94.000
575i	768x576 (Interlace)	15.625	50.000	SXGA 15	1280x1024	63.370	60.010
480i	640x480 (Interlace)	15.734	60.000	SXGA 16	1280x1024	76.970	72.000
SVGA 1	800x600	35.156	56.250	SXGA 17	1152x900	61.850	66.000
SVGA 2	800x600	37.880	60.320	SXGA 18	1280x1024 (Interlace)	46.430	86.700
SVGA 3	800x600	46.875	75.000	SXGA 19	1280x1024	63.790	60.180
SVGA 4	800x600	53.674	85.060	SXGA 20	1280x1024	91.146	85.024
SVGA 5	800x600	48.080	72.190	SXGA+ 1	1400x1050	63.970	60.190
SVGA 6	800x600	37.900	61.030	SXGA+ 2	1400x1050	65.350	60.120
SVGA 7	800x600	34.500	55.380	SXGA+ 3	1400x1050	65.120	59.900
SVGA 8	800x600	38.000	60.510	SXGA+ 4	1400x1050	64.030	60.010
SVGA 9	800x600	38.600	60.310	SXGA+ 5	1400x1050	62.500	58.600
SVGA 10	800x600	32.700	51.090	MAC 21	1152x870	68.680	75.060
SVGA 11	800x600	38.000	60.510	MAC	1280x960	75.000	75.080
MAC 16	832x624	49.720	74.550	MAC	1280x1024	80.000	75.080
XGA 1	1024x768	48.360	60.000	WXGA 1	1366x768	48.360	60.000
XGA 2	1024x768	68.677	84.997	WXGA 2	1360x768	47.700	60.000
XGA 3	1024x768	60.023	75.030	WXGA 3	1376x768	48.360	60.000
XGA 4	1024x768	56.476	70.070	WXGA 4	1360x768	56.160	72.000
XGA 5	1024x768	60.310	74.920	WXGA 6	1280x768	47.776	59.870
XGA 6	1024x768	48.500	60.020	WXGA 7	1280x768	60.289	74.893
XGA 7	1024x768	44.000	54.580	WXGA 8	1280x768	68.633	84.837
XGA 8	1024x768	63.480	79.350	WXGA 9	1280x800	49.600	60.050
XGA 9	1024x768 (Interlace)	36.000	87.170	WXGA 10	1280x800	41.200	50.000
XGA 10	1024x768	62.040	77.070	UXGA 1	1600x1200	75.000	60.000
XGA 11	1024x768	61.000	75.700	UXGA 2	1600x1200	81.250	65.000
XGA 12	1024x768 (Interlace)	35.522	86.960	UXGA 3	1600x1200	87.500	70.000
XGA 13	1024x768	46.900	58.200	UXGA 4	1600x1200	93.750	75.000
XGA 14	1024x768	47.000	58.300	720p	1280x720	45.000	60.000
XGA 15	1024x768	58.030	72.000	720p	1280x720	37.500	50.000
MAC 19	1024x768	60.240	75.080	1035i	1920x1035 (Interlace)	33.750	60.000
SXGA 1	1152x864	64.200	70.400	1080i	1920x1080 (Interlace)	33.750	60.000
SXGA 2	1280x1024	62.500	58.600		1920x1080 (Interlace)	28.125	50.000
SXGA 3	1280x1024	63.900	60.000				

*

*
*
*
*

* True cannot be selected when UXGA1, UXGA2, UXGA3, and UXGA4 are selected (p.39)

Appendix

When an input signal is digital from the DVI terminal, refer to the chart below.

ON-SCREEN DISPLAY	RESOLUTION	H-Freq. (kHz)	V-Freq. (Hz)	ON-SCREEN DISPLAY	RESOLUTION	H-Freq. (kHz)	V-Freq. (Hz)
D-VGA	640x480	31.470	59.940	D-WXGA 9	1280x800	49.600	60.050
D-480p	720x480	31.470	59.880	D-WXGA 10	1280x800	41.200	50.000
D-575p	720x575	31.250	50.000	D-720p	1280x720	45.000	60.000
D-SVGA	800x600	37.879	60.320	D-720p	1280x720	37.500	50.000
D-XGA	1024x768	43.363	60.000	D-1035i	1920x1035 (Interface)	33.750	60.000
D-WXGA 1	1366x768	48.360	60.000	D-1080i	1920x1080 (Interface)	33.750	60.000
D-WXGA 2	1360x768	47.700	60.000		1920x1080 (Interface)	28.125	50.000
D-WXGA 3	1376x768	48.360	60.000	D-1080psf/30	1920x1080	33.750	60.000
D-WXGA 4	1360x768	56.160	72.000	D-1080psf/25	1920x1080	28.125	50.000
D-WXGA 5	1366x768	46.500	50.000	D-1080psf/24	1920x1080	27.000	48.000
D-WXGA 6	1280x768	47.776	59.870				
D-WXGA 7	1280x768	60.289	74.893				

✓ **Note:**

- When the input signal is D-SXGA 1, D-SXGA 2, and D-SXGA 3, images may not be displayed properly depending on computers.
- Depending on the condition of signals and the type and length of cables, these signals may not be properly viewed.
- Specifications are subject to change without notice.

Technical Specifications

Mechanical Information

Projector Type	Multi-media Projector
Dimensions (W x H x D)	14.57" x 7.36" x 19.37" (370 mm x 187 mm x 492 mm) (Not including raised portions)
Net Weight	28.7 lbs (13.0 kg)
Feet Adjustment	0° to 6.5°

Panel Resolution

LCD Panel System	1.3" TFT Active Matrix type, 3 panels
Panel Resolution	1,024 x 768 dots
Number of Pixels	2,359,296 (1,024 x 768 x 3 panels)

Signal Compatibility

Color System	PAL, SECAM, NTSC, NTSC4.43, PAL-M, and PAL-N
High Definition TV Signal	480i, 480p, 575i, 575p, 720p, 1035i, and 1080i
Scanning Frequency	H-sync. 15 kHz–100 kHz, V-sync. 48 Hz–100 Hz

Optical Information

Projection Image Size (Diagonal)	Adjustable from 31" to 400"
Throw Distance	4.6' - 48.2' (1.4 m - 14.7 m)
Projection Lens	F= 1.7 to 2.0, f= 48.2 to 62.6 mm with motor zoom and focus
Projection Lamp	330 W NSHA lamp

Interface

Input 1	Digital (DVI-D) x 1, Analog (Mini D-sub 15 pin) x 1
Monitor Out	Analog RGB (Mini D-sub 15 pin) Terminal x 1
Input 2	BNC Type x 5 (G or Video/Y, B or Cb-Pb, R or Cr-Pr, HV and V)
Input 3	RCA Type x 3 (Video/Component), Mini DIN 4 pin x 1 (S-video)
R/C Jack	Mini jack (stereo) (Wired Remote) x 1
Control Port	D-sub 9 pin x 1
USB Connector	USB Series B x 1
Option	Network Imager Terminal x 1

Power

Voltage and Power Consumption	AC 100–120 V (4.6A Max. Ampere), 50/60 Hz (The U.S.A and Canada) AC 200–240 V (2.3A Max. Ampere), 50/60 Hz (Continental Europe and The U.K.) 490W (17.6W in stand-by mode)
-------------------------------	--

Operating Environment

Operating Temperature	41°F–104°F (5°C–40°C)
Storage Temperature	14°F–140°F (-10°C–60°C)

Remote Control Unit

Battery	AAA or LR03 Type x 2
Operating Range	16.4' (5 m/±30°)
Dimensions	1.8" (W) x 1.0" (H) x 5.7" (D) (45 mm x 25 mm x 145 mm)
Net Weight	3.5 oz (99 g) (including batteries)

Accessories

User's Manual (CD-ROM)	Light-block sheet (For option lens)
Quick Start Guide	Spacer (For option lens)
AC Power Cord	Logo Plate

Remote Control Unit and Batteries	<ul style="list-style-type: none"> ● The specifications are subject to change without notice.
VGA Cable	<ul style="list-style-type: none"> ● LCD panels are manufactured to the highest possible standards. Even though 99.99% of the pixels are effective, a tiny fraction of the pixels (0.01% or less) may be ineffective by the characteristics of the LCD panels.
USB Cable	
PIN Code Label	

Optional Parts

The parts listed below are optionally available. When ordering those parts, specify the item name and Model No. to the sales dealer.

Model No.

Ultra Wide Angle Lens	Type No. : LV-IL01
Wide Angle Zoom Lens	Type No. : LV-IL02
Long Focus Zoom Lens	Type No. : LV-IL03
Ultra Long Focus Zoom Lens	Type No. : LV-IL04
Ceiling Attachment	Type No. : LV-CL13
High Ceiling Attachment	Type No. : LV-CL14
DVI Cable	Type No. : LV-CA29
Scart-VGA Cable	Type No. : LV-CA31
Network Imager	Type No. : LV-NI02

Lens Replacement

The lens of this projector can be replaced with other optional lens. This feature enables you to use the projector for wide variety of uses.

For installation and replacement of the lens, always contact the sales dealer. The projector lens must be installed or replaced by well-trained sales or service engineers. Do not attempt to install and replace the lens by yourself as it may cause injury.



Do not hold the lens when carrying or lifting the projector. It may cause serious damage to the projector.

To the sales and service engineers:

For the lens replacement and lens installation, refer to the installation manual of the optional lens. Before replacing and installing the lens, make sure that you are using the lens with the correct Type No.

PJ Link Notice

This projector is compliant with PJLink Standard Class 1 of JBMIA (Japan Business Machine and Information System Industries Association). The projector supports all commands defined by PJLink Class 1 and is verified conformance with PJLink Standard Class 1.

Projector Input		PJLink Input	Parameter
Input 1	RGB (PC analog)	RGB 1	11
	RGB (Scart)	RGB 2	12
	RGB (PC digital)	DIGITAL 1	31
	RGB (AV HDCP)	DIGITAL 2	32
Input 2	Video	VIDEO 1	21
	Y, Pb/Cb,Pr/Cr	VIDEO 2	22
	RGB	RGB 3	13
Input 3	Video	VIDEO 3	23
	Y, Pb/Cb,Pr/Cr	VIDEO 4	24
	S-video	VIDEO 5	25
Input 4	Network	NETWORK 1	51

PJLink is a registered trademark of JBMIA and pending trademark in some countries.



Configurations of Terminals

ANALOG/ MONITOR OUT (Mini D-sub 15 pin)

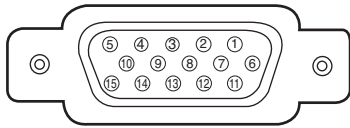

1	Red Input	9	+5V Power
2	Green Input	10	Ground (Vert. sync.)
3	Blue Input	11	Sense 0
4	Sense 2	12	DDC Data
5	Ground (Horiz.sync.)	13	Horiz. sync.
6	Ground (Red)	14	Vert. sync.
7	Ground (Green)	15	DDC Clock
8	Ground (Blue)		

DIGITAL DVI-D (DVI 24 PIN)

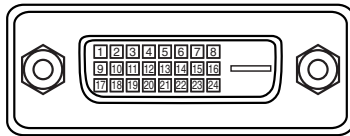

1	T.M.D.S. Data2-	9	T.M.D.S. Data1-	17	T.M.D.S. Data0-
2	T.M.D.S. Data2+	10	T.M.D.S. Data1+	18	T.M.D.S. Data0+
3	T.M.D.S. Data2 Shield	11	T.M.D.S. Data1 Shield	19	T.M.D.S. Data0 Shield
4	No Connect	12	No Connect	20	No Connect
5	No Connect	13	No Connect	21	No Connect
6	DDC Clock	14	+5V Power	22	T.M.D.S. Clock Shield
7	DDC Data	15	Ground (for +5V)	23	T.M.D.S. Clock+
8	No Connect	16	Hot Plug Detect	24	T.M.D.S. Clock-

USB CONNECTOR (Series B)

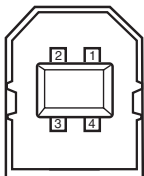

1	Vcc
2	- Data
3	+ Data
4	Ground

CONTROL PORT CONNECTOR (D-sub 9 pin)

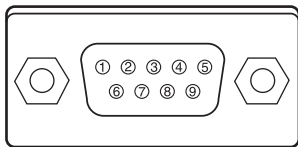

	Serial
1	---
2	R X D
3	T X D
4	---
5	SG
6	---
7	RTS
8	CTS
9	---

While the projector is locked with the PIN code...

Put the label below (supplied) on in a prominent place of the projector's body while it is locked with a PIN code.

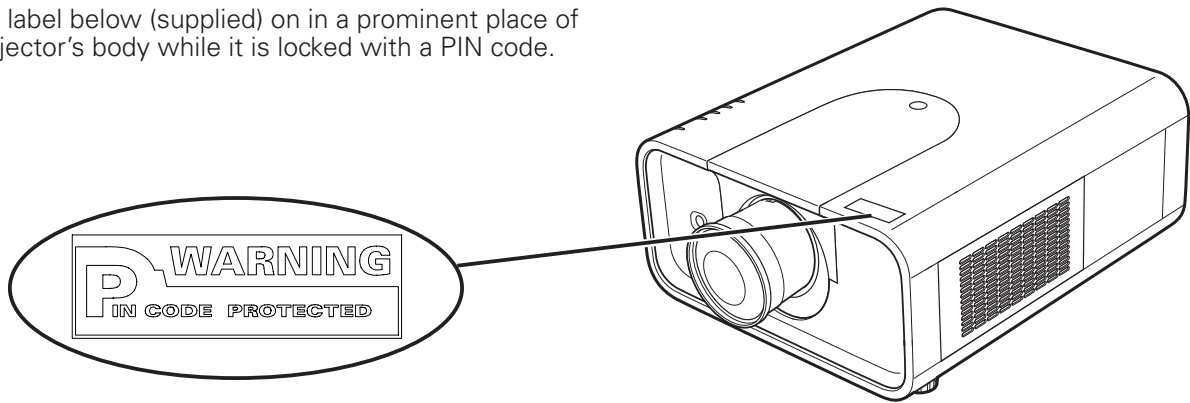

The logo is upside down when hanging the projector from the ceiling...

When hanging the projector from the ceiling, the logo looks upside down. To display the logo in correct direction, put the logo plate (supplied) on the reversed logo.

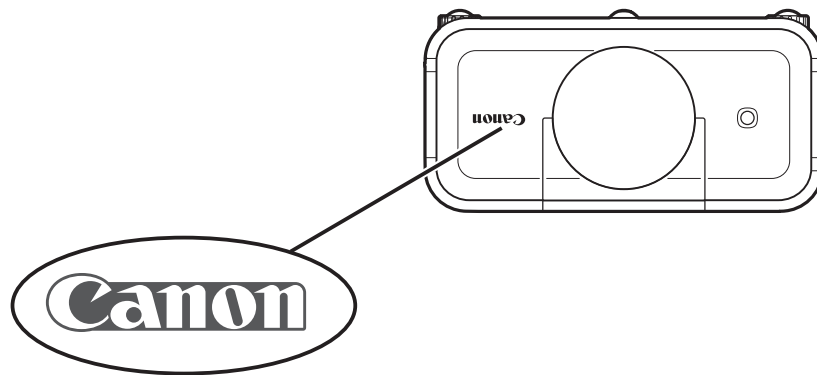

Dimensions

Unit: inch (mm)

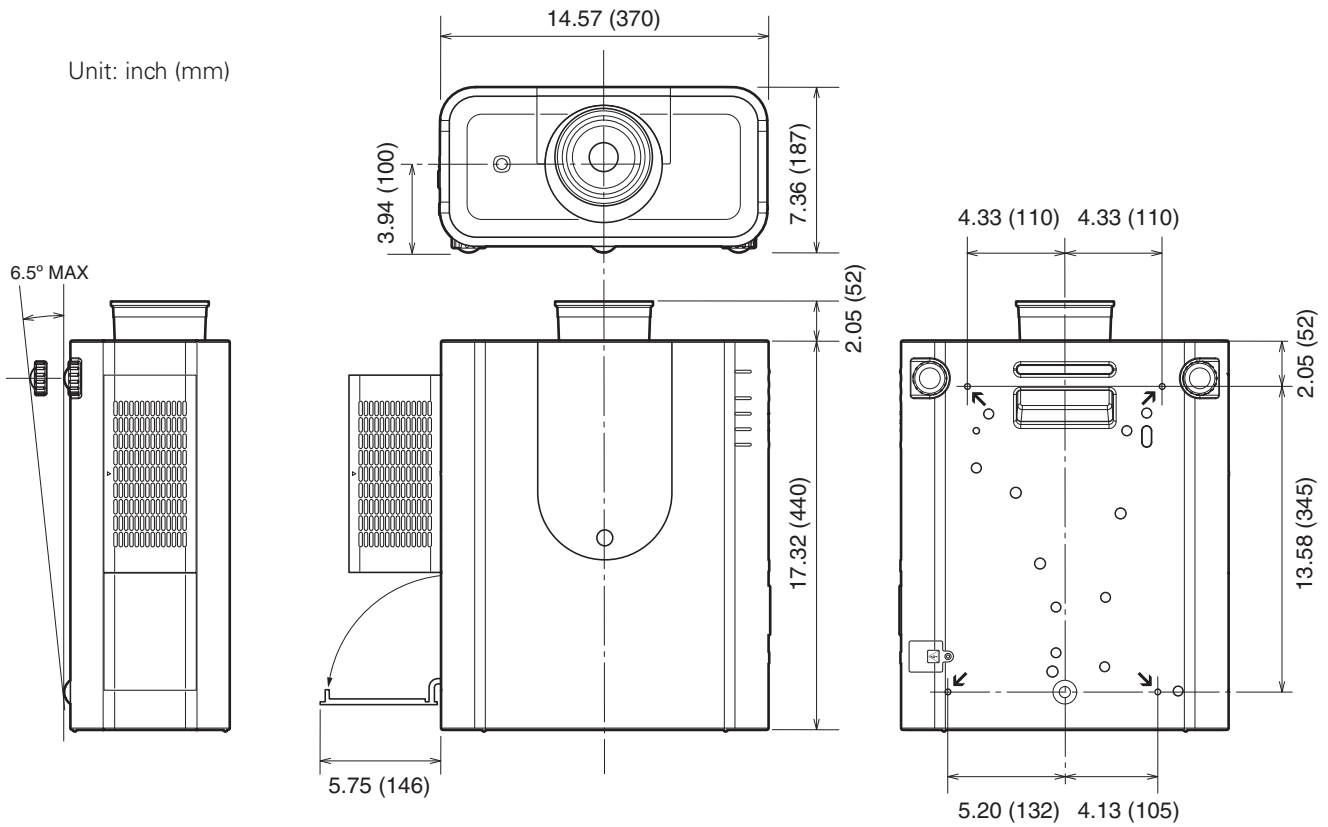

↘ Screw Holes for Ceiling Mount
Screw: M6
Depth: 0.393 (10.0)

Serial Control Interface

This projector provides a function to control and monitor the projector's operations by using the RS-232C serial port.

Operation

- 1** Connect a RS-232C serial cross cable to CONTROL PORT on the projector and serial port on the PC.
(See p.20)
- 2** Launch a communication software provided with PC and setup the communication condition as follows:

Baud rate	: 9600 / 19200 bps
Parity check	: none
Stop bit	: 1
Flow control	: none
Data bit	: 8

✓ **Note:**

- *The default of the baud rate is set to 19200 bps. If an error occurs in the communication, change the serial port and the communication speed (baud rate).*

- 3** Type the command for controlling the projector and then enter the "Enter" key.

Example

When you want to change the input to INPUT 2, Type 'C' '0' '6' 'Enter'.

✓ **Note:**

- *Enter with ASCII 64-byte capital characters and one-byte characters.*

Functional Execution Command

Format

The command is sent from PC to the projector with the format below;

'C' [Command] 'CR'

Command: two characters (refer to the command table below).

-The projector decodes the command and returns the 'ACK' with the format below;

'ACK' 'CR'

-When the projector can not decode the command, it returns with format below.

'?' 'CR'

Command	Function
C00	Turn the projector ON
C01	Turn the projector OFF (immediately OFF)
C02	Turn the projector OFF
C05	Select Input 1
C06	Select Input 2
C07	Select Input 3
C08	Select Network
C0D	Video mute ON
C0E	Video mute OFF
C0F	Aspect 4:3
C10	Aspect 16:9
C1C	Menu ON
C1D	Menu OFF
C20	Brightness UP
C21	Brightness DOWN
C23	Select Input 2 Video
C24	Select Input 2 Y, Pb/Cb,Pr/Cr
C25	Select Input 2 RGB
C28	ON Start ON
C29	ON Start OFF
C33	Select Input 3 Video
C34	Select Input 3 S-video
C35	Select Input 3 Y, Pb/Cb,Pr/Cr

Command	Function
C3A	Pointer RIGHT
C3B	Pointer LEFT
C3C	Pointer UP
C3D	Pointer DOWN
C3F	Enter
C46	Zoom DOWN
C47	Zoom UP
C4A	Focus DOWN
C4B	Focus UP
C50	Select Input 1 Analog RGB
C51	Select Input 1 SCART
C52	Select Input 1 DVI (PC Digital)
C53	Select Input 1 DVI (AV HDCP)
C5D	Lens shift UP
C5E	Lens shift DOWN
C5F	Lens shift LEFT
C60	Lens shift RIGHT
C89	Auto PC Adj.
C8E	Keystone UP
C8F	Keystone DOWN
C90	Keystone RIGHT
C91	Keystone LEFT

Status Read Command

Format

The command is sent from PC to the projector with the format below;

'CR' [Command] 'CR'

Command: one character (refer to the command table below).

The projector decodes the command and returns the 'Character string' with the format below;

Command	Function	Projector Return	Projectro status
CR0	Status Read	00	Power On
		80	Stand-by mode
		40	Countdown
		20	Cooling down
		10	Power Malfunction
		28	Cooling down at the temperature abnormally
		24	Cooling down at Power Management mode
		04	Power Management mode after Cooling down
		21	Cooling down after the projector is turned off when the lamps are out.
		81	Stand-by mode after Cooling down when the lamps are out.
		88	Stand-by mode after Cooling down at the temperature abnormally.
CR6	Temperature Read	S1 S2 S3	S1 = Temperature at Sensor 1 (°C) S2 = Temperature at Sensor 2 (°C) S3 = Temperature at Sensor 3 (°C) (ex.) S1 = 12.3°C, S2 = 23.4°C, S3 = 34.5°C --> The projector displays "12.3 23.4 34.5" (For each sensor, two digit and the tenth place numbers are displayed with a space between each temperature.)
		?	Communication failure

The tables on page 79 and 80 show the typical command lists for controlling the projector. Please consult your local dealer for further information of other commands.

**CANON INC.**

30-2, Shimomaruko 3-chome, Ohta-ku,
Tokyo 146-8501, Japan

CANON U.S.A., INC.

One Canon Plaza, Lake Success, NY 11042,
U.S.A.

CANON CANADA, INC.

6390 Dixie Road Mississauga, Ontario L5T
1P7 Canada

CANON LATIN AMERICA, INC.

703 Waterford Way Suite 400 Miami, Florida
33126 U.S.A.

CANON MEXICANA, S. de R.L. de C.V.

Boulevard Manuel Avila Camacho, No. 138
PB, Pisos 15, 16 y 17 Col. Lomas de
Chapultepec, CP 11000, Mexico D.F., Mexico

CANON EUROPA N.V.

P.O.Box 2262, 1180 EG Amstelveen, The
Netherlands

**CANON COMMUNICATION & IMAGE
FRANCE S.A.**

12 Rue De L'Industrie, 92414 Corbevoie, Cedex, France

CANON (UK) LTD.

Woodhatch, Reigate, Surrey RH2 8BF,
United Kingdom

CANON DEUTSCHLAND GmbH

Europark Fichtenhain A 10, 47807 Krefeld,
Germany

CANON ITALIA S.p.A.

Via Milano, 8 San Donato M. se-20097 (MI), Italy

CANON (Schweiz) A.G.

Industriestrasse 12, 8305 Dietlikon,
Switzerland

CANON BELGIUM N.V./S.A

Bessenveldstraat 7, 1831 Diegem, Belgium

CANON GmbH

Zetschegasse 11, A-1230 Wien, Austria

CANON ESPANA S.A.

C/Joquin Costa 41, 28002 Madrid, Spain

CANON SVENSKA AB

Gustav III:s, Boulevard 26, 169 88 Solna, Sweden

CANON NORGE A/S

Hallagerbakken 110, P.O. Box 33, Holmlia,
N-1201 Oslo, Norway

CANON OY

Huopalahdentie 24, P.O. Box 1, FIN-00351
Helsinki, Finland

CANON HONGKONG CO., LTD.

19/F, The Metropolis Tower, 10 Metropolis
Drive, Hung Hom, Kln., H.K.

CANON SINGAPORE PTE. LTD.

1 HarbourFront Avenue #04-01, Keppel Bay
Tower Singapore 098632

CANON AUSTRALIA PTY. LTD.

1 Thomas Holt Drive, North Ryde, Sydney,
N.S.W.2113, Australia

CANON NEW ZEALAND LTD.

Akoranga Business Park, Akoranga Drive,
Northcote, Auckland, New Zealand

CANON DANMARK A/S

Knud Hoejgaards Vej 1, DK-2860 Soeborg, Denmark