

High-Quality, Easy-to-Use Compact Photo Printer.

- Light, compact body and an optional battery makes it easy to take this printer with you
- Preview your images on the built-in 2.5" tilt-up LCD
- Enhance your photos with the improved "Portrait Image Optimize"
- Print water resistant photos that last up to 100 years¹ in just 47 seconds²
- Print directly from your memory cards³, compatible digital camera, USB flash drive or wirelessly from a Bluetooth⁴ enabled device



FEATURES

SPEED & QUALITY

Dye-Sub

100
YEARS
PRINT

47²
sec.
4"×6"

16.8
million
COLORS

Exif Print

DPOF
Digital Print Order Format

Smooth Skin

EASE OF USE

Borderless Printing

Tilt-up

My Colors

ID Photo Print



Red-eye
Correction

Portrait
Image Optimize

Shuffle

NR
Noise Reduction
Technology

CONNECTIVITY

Memory Card³

Camera
Phone
Printing^{4,5}

USB
Memory

PictBridge

Bluetooth⁴
(Optional)

USB

OPTIONAL

BATTERY

CANON
IMAGE
GATEWAY

Windows
Mac

TECHNICAL SPECIFICATIONS

PRINT	
Print Features	Borderless/Bordered, Brightness (Manual), Date Print, DPOF ⁵ , File No. Print, Face Fine Print, ID Photo Print (6 copies of 1 image), Index Print, Layout Print (Fixed Size, 1-up/2-up/4-up/8-up), Movie Print, Potrait Image Optimize (i-Contrast, Noise Reduction), Shuffle (8 / 20 images per sheet), Smooth Skin, Wireless Printing (via Bluetooth device)
Print Speed²	Postcard Size Borderless Photo: 47 seconds
Printing Technology	Dye-Sublimation
Print Resolution (Up to)	Color: 300 x 300 dpi
Gradation	256 Levels per color
Paper Sizes	Card Size (2.13" x 3.39"), Postcard (3.94" x 5.83")
Paper Cartridge Capacity	36 Sheets (Postcard size)
MEMORY CARD SUPPORT³	
	SD™ Memory Card
	miniSD™ Card
	microSD™ Card
	SDHC™ Memory Card
	SDXC™ Memory Card
	miniSDHC™ Card
	microSDHC™ Card
	microSDXC™ Card
	MultiMediaCard®
	MMC <i>plus</i> Card
	MMC <i>mobile</i> Card
	MMC <i>micro</i> Card
	HC MMC <i>plus</i> Card
	RS-MMC™ Card
	CF® Card
	Microdrive®
	xD-Picture Card™
	Memory Stick®
	Memory Stick PRO™
	Memory Stick Duo™
	Memory Stick PRO Duo™
	Memory Stick Micro™



GENERAL	
Standard Interface	Bluetooth® v2.0 ⁴ (Optional) Card Slots (See Memory Card Support) PictBridge (Cable not included) USB USB Flash Drive
General Features	2.5" tilt-up LCD, 8 Multi Language UI, Battery (Optional), My Colors, PictBridge, Red-Eye Correction, Power Save, Anti-theft Wire Lock Slot (Kensington lock-style)
OS COMPATIBILITY⁷	
Windows®7, Windows Vista®, Windows XP and Mac OS® X v10.4 to v10.6.x	
SOFTWARE (WINDOWS/MAC)	
Setup Software & User's Guide CD-ROM Canon Utilities EOS Utility SELPHY CP800 (White) Printer Driver Compact Photo Printer Solution Disk SELPHY Photo Print	
WARRANTY⁸	
1-year limited warranty with InstantExchange program. 1-year toll-free technical phone support.	
BOX CONTENTS	
CP1 (White) Compact Photo Printer Paper Cassette (Postcard Size) Trial Standard Paper Pack (Postcard Size) Trial Ink Cassette (Postcard Size) Compact Power Adapter CP Printer Solution Disk AC Cable Document Kit: Support Center List User Registration Information Setup Software & User's Guide CD-ROM User Guide	







SELPHY CP800 (White)

Compact Photo Printer

ORDERING INFORMATION

MODEL NUMBER	DESCRIPTION	ITEM NUMBER	UPC CODE
SELPHY CP800 (White)	Compact Photo Printer	4595B001	
	Master Carton UPC		 10013803126034

OPTIONAL CONSUMABLES			
KC-18IF	Card "Full" Label/Ink Set 18 Sheets * PCC-CP300 Required	7741A001	
KC-18IL	Card "Mini" Label/Ink Set 18 Sheets * PCC-CP300 Required	7740A001	
KC-36IP	Card Size Label/Ink Set 36 Sheets * PCC-CP300 Required	7739A001	
KP-36IP	Postcard/36 Sheets	7737A001	
KP-108IN	Photo Paper/108 Sheets	3115B001	

ACCESSORIES			
BU-30	Bluetooth Adapter	2553B002	
PCC-CP300	Card Size Paper Cassette	2562B001	
NB-CP2L	Battery Pack	0188B001	

FOR REFERENCE ONLY

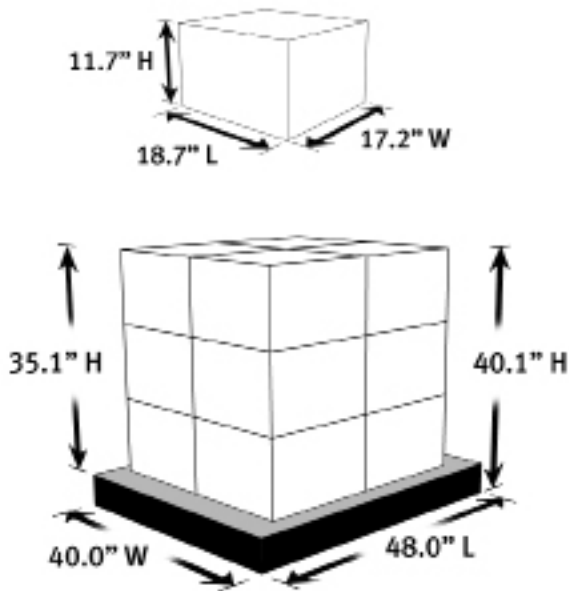

PALLET INFORMATION

ORIGIN	
Country of Origin	China
Tariff Number	8443321050
PRODUCT INFORMATION	
Individual Printer Dimensions	6.7" (L) x 4.7" (W) x 2.3" (H)
Individual Box Dimensions	10.2" (L) x 9.1" (W) x 5.5" (H)
Master Carton Dimensions	18.7" (L) x 17.2" (W) x 11.7" (H)
Individual Printer Weight	2.0 lbs.
Individual Box Weight	4.0 lbs.
Master Carton Weight	29.4 lbs.
PALLET INFORMATION	
Number of Boxes per Master Carton	6
Number of Master Cartons per Pallet	12
Dimensions (Pallet and MC)	48.0" (L) x 40.0" (W) 40.1" (H)
Dimensions without Pallet	37.4" (L) x 34.4" (W) 35.1" (H)
Loaded Pallet Weight	402.8 lbs.
DATE	
Availability	September 2010

SPECIFICATIONS ARE SUBJECT TO CHANGE WITHOUT NOTICE. ALL VIEWSCREEN AND PRINTER OUTPUT IMAGES ARE SIMULATED

- 1 Based on accelerated dark storage testing by Canon under controlled lighting, temperature and humidity conditions. Canon cannot guarantee the longevity of the prints; results may vary depending on printed images, display/storage conditions and environmental factors.
- 2 Print speed obtained using compatible Canon compact digital camera incorporating DIGIC II (other camera models may vary).
- 3 Compatible memory cards include SD™ Memory Card, SDHC™ Memory Card, SDXC™ Memory Card, MultiMediaCard®, MMC*plus* Card, HC MMC*plus* Card, CompactFlash® Card, Microdrive®, Memory Stick®, Memory Stick® PRO™, Memory Stick® Duo™ and Memory Stick® PRO Duo™. The following can be used with the addition of a special adapter sold separately: microSD™ Card, miniSD Card, microSDHC™ Card, miniSDHC™ Card, microSDXC™ Card, RS-MMC™, MMC*micro* Card, MMC*mobile* Card, xD-Picture Card® and Memory Stick Micro™.
- 4 Requires mobile phone (or other device) equipped with Bluetooth v2.0 and optional Canon Bluetooth Unit BU-30. Bluetooth operation depends on the device and software version used. Operating distance is approx. 10 meters but may vary due to obstacles, radio signals, locations where radio interference occurs, magnetic fields from microwave ovens, device sensitivity and/or antenna performance.
- 5 Requires mobile phone equipped with PictBridge technology and a USB cable.
- 6 Supports DPOF "Both" mode of both standard and index printing.
- 7 System requirements vary by application.
- 8 Warranty programs are subject to certain conditions and restrictions. See www.usa.canon.com/support for details.



©2010 Canon U.S.A., Inc. Canon and SELPHY are registered trademarks of Canon Inc. in the United States and may be registered trademarks in other countries. Microsoft, Windows, Windows Vista, the Windows Vista logo, Windows 7 and the Windows 7 logo are trademarks or registered trademarks of Microsoft Corporation in the United States and other countries. Macintosh and Mac are trademarks of Apple Inc., registered in the United States and other countries. The USB-IF logo is a trademark of Universal Serial Bus Implementers Forum, Inc. All other product and brand names are trademarks of their respective owners. As an ENERGY STAR® partner, Canon U.S.A., Inc. has determined that this product meets the ENERGY STAR® guidelines for energy efficiency.



USB

