

Canon

 imageFORMULA

DR-7090C

User Manual

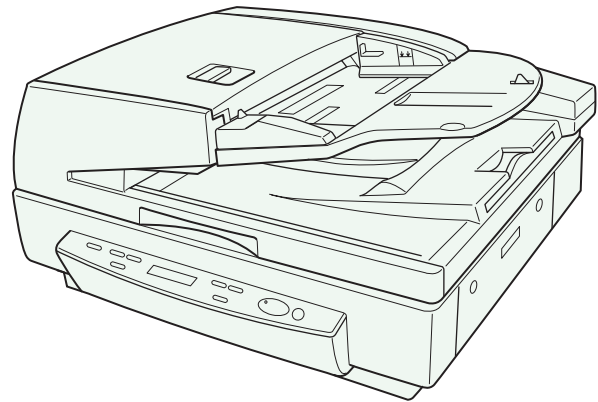

Please read this manual before using the scanner.
After you finish reading this manual, keep it in a safe place
for future reference.

FCC REGULATIONS (For 120 V model)

Document Scanner, Model M11067

This device complies with Part 15 of the FCC Rules.

Operation is subject to the following two conditions: (1) This device may not cause harmful interference, and (2) this device must accept any interference received, including interference that may cause undesired operation.

Note: This equipment has been tested and found to comply with the limits for a Class B digital device, pursuant to Part 15 of the FCC Rules. These limits are designed to provide reasonable protection against harmful interference in a residential installation. This equipment generates, uses, and can radiate radio frequency energy and, if not installed and used in accordance with the instructions, may cause harmful interference to radio communications. However, there is no guarantee that interference will not occur in a particular installation. If this equipment does cause harmful interference to radio or television reception, which can be determined by turning the equipment off and on, the user is encouraged to try to correct the interference by one or more of the following measures:

- Reorient or relocate the receiving antenna.
- Increase the separation between the equipment and receiver.
- Connect the equipment into an outlet on a circuit different from that to which the receiver is connected.
- Consult the dealer or an experienced radio/TV technician for help.

Use of shielded cable is required to comply with class B limits in Subpart B of Part 15 of FCC Rules.

Do not make any changes or modifications to the equipment unless otherwise specified in the manual. If such changes or modifications should be made, you could be required to stop operation of the equipment.

Canon U.S.A. Inc.

One Canon Plaza, Lake Success NY 11042, U.S.A.

Tel. No. (516)328-5000

RADIO INTERFERENCE REGULATIONS (For 120 V models)

This digital apparatus does not exceed the Class B limits for radio noise emissions from digital apparatus as set out in the interference-causing equipment standard entitled “Digital Apparatus”, ICES-003 of the Industry Canada.

RÈGLEMENT SUR LE BROUILLAGE RADIOÉLECTRIQUE (For 120 V models)

Cet appareil numérique respecte les limites de bruits radioélectriques applicables aux appareils numériques de Classe B prescrites dans la norme sur le matériel brouilleur: “Appareils Numériques”, NMB-003 édictée par l’Industrie Canada.

International ENERGY STAR® Office Equipment Program



As an ENERGY STAR® Partner, Canon Electronics Inc. has determined that this machine meets the ENERGY STAR® Program guidelines for energy efficiency.

The International ENERGY STAR® Office Equipment Program is an international program that promotes energy saving through the use of computers and other office equipment. The program backs the development and dissemination of products with functions that effectively reduce energy consumption. It is an open system in which business proprietors can participate voluntarily. The targeted products are office equipment, such as computers, monitors, printers, fax, machine, copiers, and scanners. The standards and logos are uniform among participating nations.

European Union (and EEA) only.



This symbol indicates that this product is not to be disposed of with your household waste, according to the WEEE Directive (2002/96/EC) and your national law. This product should be handed over to a designated collection point, e.g., on an authorized one-for-one basis when you buy a new similar product or to an authorized collection site for recycling waste electrical and electronic equipment (EEE). Improper handling of this type of waste could have a possible negative impact on the environment and human health due to potentially hazardous substances that are generally associated with EEE. At the same time, your cooperation in the correct disposal of this product will contribute to the effective usage of natural resources. For more information about where you can drop off your waste equipment for recycling, please contact your local city office, waste authority, approved WEEE scheme or your household waste disposal service. For more information regarding return and recycling of WEEE products, please visit www.canon-europe.com/environment. (EEA: Norway, Iceland and Liechtenstein)

Für EMVG

Dieses Produkt ist zum Gebrauch im Wohnbereich, Geschäfts-und Gewerbebereich sowie in Kleinbetrieben vorgesehen.

Für 3. GPSGV

“Maschinenlärminformations-Verordnung 3. GPSGV: Der höchste Schalldruckpegel beträgt 70 dB(A) oder weniger gemäß EN ISO 7779”

Model Names

The following names may be provided for the safety regulations in each sales region of the Document Scanner.
DR-7090C: Model M11067

Trademarks

- Canon and the Canon logo are registered trademarks of Canon Inc. in the United States and may also be trademarks or registered trademarks in other countries.
- imageFORMULA is a registered trademark of Canon Electronics Inc.
- Microsoft and Windows are either registered trademarks or trademarks of Microsoft Corporation in the United States and other countries.
- Adobe, Acrobat, and Adobe Reader are registered trademarks or trademarks of Adobe Systems Incorporated in the United States and other countries.
- ISIS™ and MultiStream™ are trademarks of EMC Corporation in the United States.
- Other product and company names herein are, or may be, the trademarks of their respective owners.

Copyright

Copyright 2008 by CANON ELECTRONICS INC. All rights reserved.

No part of this publication may be reproduced or transmitted in any form or by any means, electronic or mechanical, including photocopying and recording, or by any information storage or retrieval system without the prior written permission of CANON ELECTRONICS INC.

Disclaimers

The information in this document is subject to change without notice.

CANON ELECTRONICS INC. MAKES NO WARRANTY OF ANY KIND WITH REGARD TO THIS MATERIAL, EITHER EXPRESS OR IMPLIED, EXCEPT AS PROVIDED HERE IN, INCLUDING WITHOUT LIMITATION, THEREOF, WARRANTIES AS TO MARKETABILITY, MERCHANTABILITY, FITNESS FOR A PARTICULAR PURPOSE OF USE OR NON-INFRINGEMENT. CANON ELECTRONICS INC. SHALL NOT BE LIABLE FOR ANY DIRECT, INCIDENTAL, OR CONSEQUENTIAL DAMAGES OF ANY NATURE, OR LOSSES OR EXPENSES RESULTING FROM THE USE OF THIS MATERIAL.

Introduction

Thank you for purchasing the Canon imageFORMULA DR-7090C Document Scanner. Please read this and the following manuals thoroughly before using the scanner to become acquainted with its capabilities and make the most of its many functions. After reading the manuals, store them in a safe place for future reference.

Manuals for the Scanner

The documentation for the scanner consists of the *Easy Start Guide* and the *Reference Guide* (supplied with the scanner), the *User Manual* (this manual), and the *CapturePerfect 3.0 Operation Guide*, which are provided in electronic form and registered in the menu during software installation.

Easy Start Guide

This manual describes the procedures for setting up the scanner for use. Please follow the procedures in the *Easy Start Guide* to set up the scanner.

Reference Guide

This manual consists of the basic scanner operating instructions extracted from the *User Manual*.

User Manual (This Manual)

This manual consists of two sections: Hardware and Software.

The Hardware section provides general information about the scanner operational settings, maintenance, and troubleshooting.

The Software section describes how to use the ISIS/TWAIN driver with the scanner, and how to set up job registration tools.

CapturePerfect 3.0 Operation Guide (Electronic Manual)

This is the operation guide for CapturePerfect 3.0, the Canon document scanner application program.

Hint

- The User Manual and the CapturePerfect 3.0 document files are installed in the following locations during software installation.

User Manual

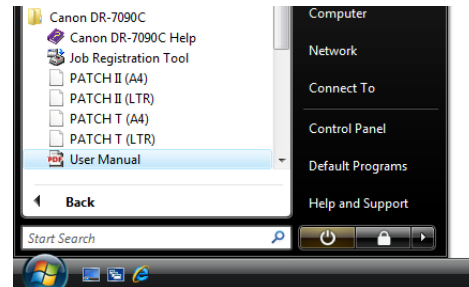

CapturePerfect 3.0 Operation Guide

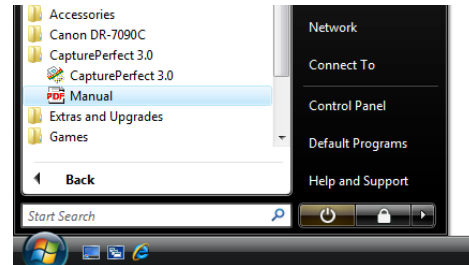

- Electronic versions of all manuals are available for viewing from the Setup CD. (See p. 2-5.)

Symbols Used in This Manual

The following symbols are used in this manual to explain procedures, restrictions, handling precautions, and instructions that should be observed for safety.

WARNING

Indicates a warning concerning operations that may lead to death or injury to persons if not performed correctly. To use the scanner safely, always pay attention to these warnings.

CAUTION

Indicates a caution concerning operations that may lead to injury to persons, or damage to property if not performed correctly. To use the scanner safely, always pay attention to these cautions.

IMPORTANT

Indicates operational requirements and restrictions. Be sure to read these items carefully to operate the scanner correctly, and avoid damage to the scanner.

Hint

Indicates a clarification of an operation, or contains additional explanations for a procedure. Reading these notes is highly recommended.

How This Manual is Organized

This manual consists of the following chapters.

■ **Hardware**

Chapter 1 Before You Start Using the Scanner

Provides an overview of the DR-7090C

Chapter 2 Setup

Describes the DR-7090C operating environment and how to connect to a PC

Chapter 3 Basic Operation

Describes the basic uses of the DR-7090C

Chapter 4 User Modes

Describes the User Mode and other functions

Chapter 5 Maintenance

Describes routine cleaning and roller replacement

Chapter 6 Practical Examples

Describes displayed messages and troubleshooting solutions

Chapter 7 Appendix

Provides a list of specifications and support information

■ **Software**

Chapter 8 ISIS/TWAIN Driver Settings

Describes the settings for the ISIS/TWAIN driver

Chapter 9 Job Registration Tool Settings

Describes the settings for the Job Registration Tool

Chapter 10 Practical Examples

Provides information for reference when making software settings

User Manual

Hardware

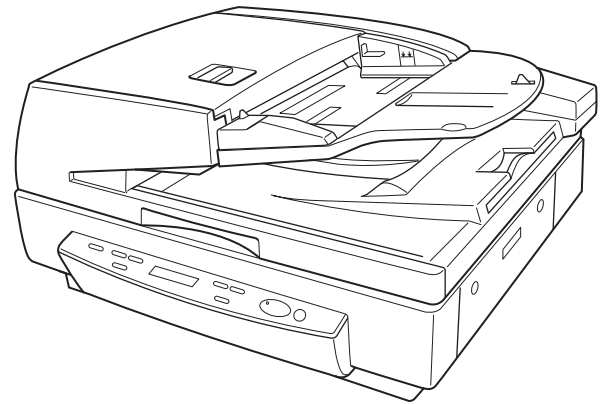

Please read this manual before using the scanner.
After you finish reading this manual, keep it in a safe place
for future reference.

Table of Contents

Introduction.....	iii
Manuals for the Scanner	iii
Symbols Used in This Manual.....	iv
How This Manual is Organized.....	iv
Chapter 1 Before You Start Using the Scanner	
1. Important Safety Instructions.....	1-2
Installation Location.....	1-2
Removing the Transportation Screw	1-2
Installing the Securing Braces	1-3
Power	1-3
Checking the Rear Cables.....	1-4
Opening and Closing the Feeder.....	1-4
Moving the Scanner.....	1-4
Handling	1-5
Disposal.....	1-7
2. Features	1-8
3. Names and Functions of Parts	1-11
Feeder.....	1-11
Flatbed.....	1-11
Rear.....	1-12
Operation Panel.....	1-12
4. Optional Products	1-14
Stamp Unit.....	1-14
Chapter 2 Setup	
1. Setup Procedures.....	2-2
2. Installation Requirements	2-3
3. Software Installation	2-4
About the Setup Menu.....	2-4
4. Connecting the Scanner to the Computer	2-6
Interface Connector Locations.....	2-6
Using a USB Connection.....	2-6
Using a SCSI Connection.....	2-7
5. Turning the Power ON (Scanner Recognition).....	2-9
About the Power Switch	2-9
Scanner Recognition	2-9

Chapter 3 Basic Operation

1. Documents	3-2
Types of Documents.....	3-2
Feeder Capacity	3-3
2. Placing Documents onto the Scanner	3-4
Loading a Document into the Feeder	3-4
Positioning a Document on the Flatbed (Platen Glass).....	3-5
3. Document Feeding.....	3-8
Scan Procedure.....	3-8
4. Scanning	3-11
About the Job Function.....	3-11
CapturePerfect 3.0	3-14
5. Using Patchcode Sheets.....	3-19
About Patchcode Sheets.....	3-19
How to Use Patchcode Sheets.....	3-20
6. Count Only Mode	3-21
7. Clearing Paper Jams.....	3-22
Clearing a Paper Jam.....	3-22
Paper Jam Causes	3-24

Chapter 4 User Modes

1. About the User Modes	4-2
User Mode Functions	4-2
How to Set the User Modes.....	4-3

Chapter 5 Maintenance

1. Changing the Stamp Cartridge.....	5-2
2. Daily Cleaning	5-4
About the Cleaning Cloth and Cleaning Paper.....	5-4
Cleaning the Main Unit	5-4
Cleaning the Flatbed (Platen Glass) and Pressure Board.....	5-5
Cleaning the Feeder.....	5-6
Cleaning the Power Plug.....	5-12

Chapter 6 Practical Examples

1. Messages	6-2
Status Display.....	6-2
Error Messages	6-3

2. Troubleshooting.....	6-5
Trouble Categories.....	6-5
Problem and Solution.....	6-5
3. Uninstalling the Software.....	6-11
Uninstalling the ISIS/TWAIN Driver.....	6-11

Chapter 7 Appendix

1. Specifications.....	7-2
Specifications for the Scanner.....	7-2
Options.....	7-3
Consumables.....	7-3
External Dimensions.....	7-4
2. Index.....	7-5

Chapter 1 Before You Start Using the Scanner

1. Important Safety Instructions	1-2
Installation Location	1-2
Removing the Transportation Screw	1-2
Installing the Securing Braces.....	1-3
Power	1-3
Checking the Rear Cables	1-4
Opening and Closing the Feeder	1-4
Moving the Scanner	1-4
Handling	1-5
Disposal	1-7
2. Features.....	1-8
3. Names and Functions of Parts	1-11
Feeder	1-11
Flatbed	1-11
Rear	1-12
Operation Panel	1-12
4. Optional Products	1-14
Stamp Unit	1-14

1. Important Safety Instructions

To ensure the safe operation of this scanner, be sure to read the safety warnings and precautions described below.

Installation Location

The performance of this scanner is affected by the environment in which it is installed. Make sure that the location where the scanner is installed meets the following environmental requirements.

- Provide adequate space around the scanner for operation, maintenance, and ventilation.

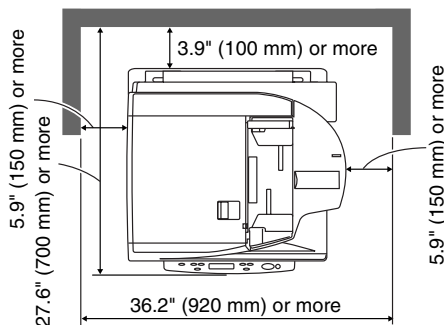

- Avoid installing the machine in direct sunlight. If this is unavoidable, use curtains to shade the scanner.
- Avoid locations with excessive dust or cigarette smoke. Dust and smoke can have negative effects on the inner parts of the scanner.
- Avoid warm or humid locations, such as in the vicinity of a water faucet, water heater, or humidifier, and avoid locations where the fumes from ammonia, paint thinner, or other volatile chemicals may be present.
- Avoid locations that are subject to vibration.

- Avoid exposing the scanner to rapid changes in temperature. If the room in which the scanner is installed is cold but rapidly heated, water droplets (condensation) may form inside the scanner. This may result in a noticeable degradation in scanning quality.

The following conditions are recommended for optimal scanning quality:

Room temperature: 15 °C to 30 °C (59 °F to 86 °F)

Humidity: 25% to 80% RH

- Avoid installing the scanner near equipment that generates a magnetic field (e.g. speakers, televisions, or radios).

Removing the Transportation Screw

Three transportation screws are preinstalled at the factory to secure the scanner's optical unit and protect it from damage caused by vibration and shock during shipment. Make sure to remove these screws before using the scanner.

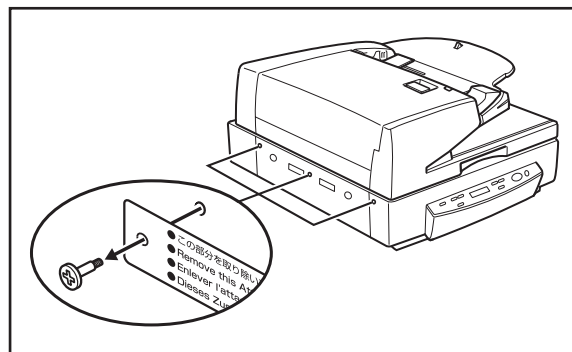

⚠ CAUTION

- If you turn the scanner ON without removing the transportation screws, error code E2020001 appears. Turn the power OFF, and remove the transportation screws and tag.
- As the transportation screws are necessary when transporting the scanner, do not throw them away. Make sure to store them for later use.

Installing the Securing Braces

The securing braces prevent the scanner from tipping backward when the feeder is open. Make sure to install the securing braces before using the scanner.

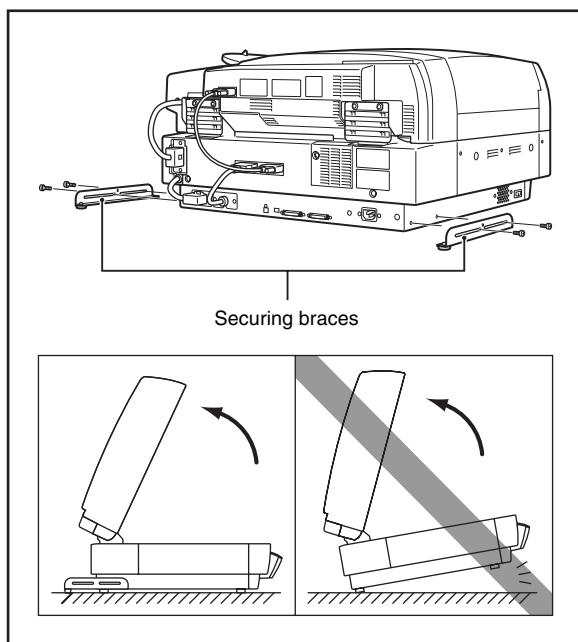
**Power**

- Connect only to a power outlet of the rated voltage and power supply frequency (either 120 V, 60 Hz or 220-240 V, 50/60 Hz, depending on your region).
- Do not use the scanner with a power supply that is not rated for the specified voltage. Doing so might cause fire or electric shock.
- Do not connect other electrical equipment to the same power outlet to which the scanner is connected. Also, when using an extension cord, make sure that the extension cord is rated for the current requirements of the scanner.
- The power cord may become damaged if it is often stepped on or if heavy objects are placed on it. Continued use of a damaged power cord can lead to an accident, such as a fire or electrical shock.
- Never bundle the power cord or wrap the cord around an object, such as a table leg.
- Do not pull directly on the power cord. When disconnecting the power cord, grasp the plug and remove it from the outlet.
- Keep the area around the power plug clear of objects so that the power cord can be disconnected easily in an emergency.
- If you have any questions regarding the power supply, contact your local authorized Canon dealer or service representative for further information.

Checking the Rear Cables

Before connecting to the computer, make sure that cable connectors **A** to **E** are properly connected at the rear of the scanner.

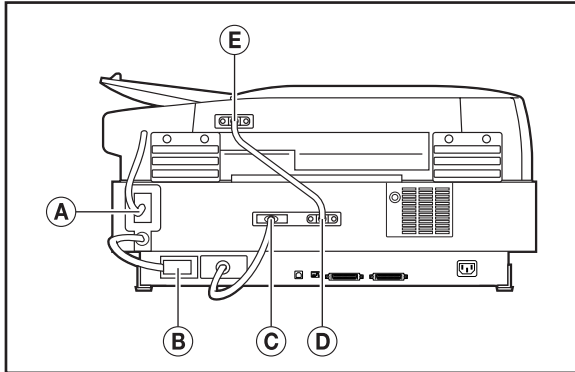

- Close the feeder carefully and slowly, taking care to avoid pinching your fingers.

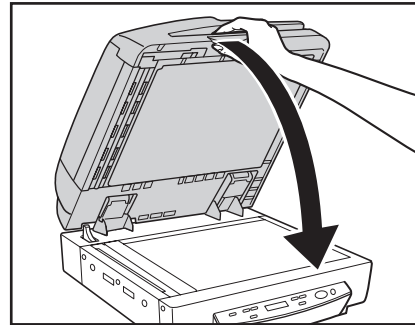

- To prevent the scanner from tipping backward when the feeder is open, install the securing braces. (See p. 1-3.)

Opening and Closing the Feeder

- Open the feeder carefully and slowly, taking care to avoid letting the feeder fall over backwards.

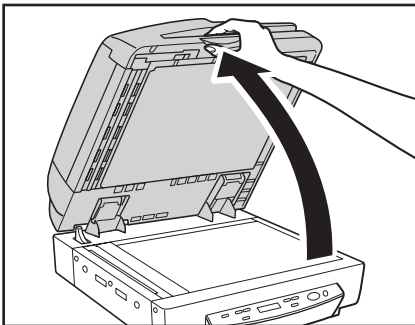

Moving the Scanner

- The scanner weighs about 41 kg (90.4 lb). To lift or move the scanner, always use two people, one on each side. Never attempt to lift the scanner by yourself. You could drop the scanner or pinch your fingers, resulting in personal injury or damage to the scanner. Remember to be extra careful when moving it.

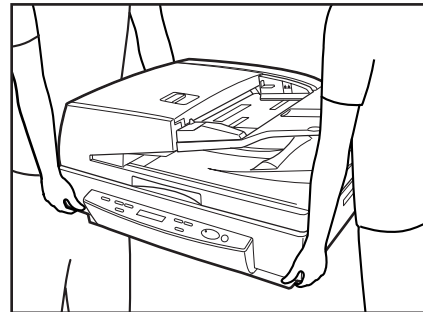

- Make sure to disconnect the interface cable and power cord when moving the scanner. If the scanner is carried with these items connected, the plugs and connectors may be damaged or cause the scanner to fall and result in personal injury or damage to the scanner.

■ Installing the Transportation Screws

When moving the scanner, you must secure the optical unit using the three transportation screws that you removed. Use the following procedure to return the optical unit to its default position and install the transportation screws.

1. Connect the power cord.
2. Turn the power switch ON while holding down the Enter and New File keys. (See p. 1-12.)

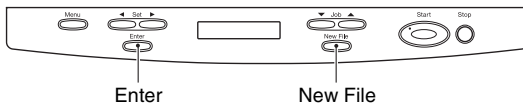

3. Continue to hold down the Enter and New File keys until "Power Off" appears on the display panel, and then turn the power switch OFF.

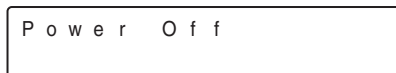

4. Secure the optical unit by installing the three transportation screws.

Handling

⚠ WARNING

Note the following precautions whenever using the scanner. Failure to do so may result in a fire or electric shock.

- Never place alcohol, benzene, paint thinners, or other flammable substances near the scanner.
- Do not cut, damage, or modify the power cord. Do not place heavy objects on the power cord, and do not pull or excessively bend the power cord.
- Never connect the power cord when your hands are wet.
- Do not connect the scanner to a multiplug power strip.
- Do not knot or coil the power cord, as this may result in a fire or electric shock. When connecting the power cord, make sure that the power plug is securely and completely inserted into the power outlet.
- To use a reel-type extension cord, unwind all of the cord from the reel. Long-term operation with the cord wound on the reel may cause the cord to overheat and could cause a fire.
- Do not use power cords other than the power cord provided with this scanner.
- Never try to take the scanner apart or modify it in any way, as this is dangerous and may lead to a fire or electric shock.
- Do not use flammable aerosol sprays products near the scanner.
- When cleaning the scanner, turn the power switch OFF and disconnect the power cord from the power supply.

- Some parts can only be cleaned when the power is turned ON. In these cases, be careful to avoid electric shock.
- Clean the scanner using a slightly dampened cloth which has been well wrung out. Never use alcohol, benzene, paint thinner, or any other flammable substances.
- If the scanner makes strange noises, or gives off smoke, heat, or strange odors, or the scanner does not function or other abnormalities occur when you use the scanner, immediately turn the power switch OFF, and disconnect the power plug from the power outlet. Then, contact your local authorized Canon dealer or service representative for further information.
- Do not drop the scanner, or subject it to impact or strong shock. Should the scanner ever become damaged, immediately turn the power switch OFF, and disconnect the power plug from the power outlet. Then, contact your local authorized Canon dealer or service representative to have the unit serviced.
- Before moving the scanner, make sure to turn the power switch OFF, and disconnect the power plug from the power outlet.
- **Notice to Cardiac Pacemaker Users**
This product emits low level magnetic flux. If you use a cardiac pacemaker and feel abnormalities, please be away from this product and consult your doctor.

**CAUTION**

- Do not install the scanner on a surface that is unstable or tilted, or in an area subject to excessive vibrations, as this may cause the scanner to fall, resulting in personal injury or damage to the scanner.
- Do not block the ventilation openings. Doing so could cause the scanner to overheat, creating a risk of fire.
- Keep all liquids, beverages, or any type of liquid, and clips, staples, necklaces, or other metal objects away from the scanner. If you accidentally spill liquid or drop a metal object into the scanner, turn OFF the power immediately and disconnect the power cord from the power outlet. Then, contact your local authorized Canon dealer or service representative to have the unit serviced.
- Do not locate the scanner in a humid or dusty location. Doing so may cause a fire or electric shock.
- Do not place objects on top of the scanner. Such objects may tip or fall over, resulting in personal injury.
- When unplugging the power cord, grasp it firmly by its plug. Do not pull directly on the power cord, as this may damage or expose the cord's internal wiring, resulting in a fire or electric shock.
- Leave sufficient space around the power plug so that it can be unplugged easily. If objects are placed around the power plug, you will be unable to unplug it in an emergency.
- Do not allow water or flammable substances (alcohol, paint thinner, benzene, etc.) to spill into the scanner, as this may result in a fire or electric shock.

- Turn OFF the power switch for safety when not using the scanner for a long period of time, such as overnight. Also, turn OFF the power switch, and disconnect the power cord from the power outlet for safety when the machine will not be used for an extended period of time, such as during consecutive holidays.
- Do not wear loose clothing or jewelry that may get caught in the scanner while you are using it. This may result in personal injury. Be extra careful of neckties and long hair. If anything becomes caught in the scanner, immediately disconnect the power cord to stop the scanner.
- Be careful when placing paper in the scanner and when removing jammed paper. It is possible to cut your hand on the edge of a sheet of paper.
- Do not open the feeder cover while the scanner is operating. Doing so might result in a malfunction or injury.
- Do not directly touch the pins and contacts on the scanner's connector with your hands. Doing so might result in a malfunction.
- Open the feeder carefully and slowly, taking care to avoid letting it fall over backwards. Failure to do so might result in a malfunction or personal injury.
- Close the feeder carefully and slowly, taking care to avoid pinching your hands. Failure to do so might result in a malfunction or personal injury.
- When scanning a thick book or similar item from the flatbed (platen glass), avoid pressing down hard on the feeder. Doing so might damage the glass and create the risk of a malfunction or personal injury.
- Never place any object other than documents to be scanned onto the scanner's flatbed (platen glass). Doing so might result in a malfunction or personal injury.

Disposal

- When disposing of this scanner, make sure to follow all local ordinances and laws or consult with the retailer who sold you the scanner.

2. Features

The main features of the DR-7090C are described below.

Scanner Features

- **High-speed scanning**
The feeder supports scanning of LTR/A4-size documents at speeds up to 70 pages per minute.
- **Single-pass duplex (two-side) scanning**
When scanning two-sided documents with the feeder, the front and back sides of the document are scanned simultaneously.
When the Long Document mode is set to ON in the user mode settings, two-sided documents are scanned one side at a time. (See “User Mode Functions” on p. 4-2.)
- **Flatbed scanning**
Flatbed scanning is also supported for thin paper, paper that does not feed properly, magazines, bound documents, and other documents that cannot be scanned using the feeder.
- **Feeding capacity of up to 100 pages**
The paper feed tray allows you to load up to 100 sheets of standard copy paper at one time.
- **Variety of Scanning Modes**
The scanner is equipped with six scanning modes: Black and White, Error Diffusion, Advanced Text Enhancement, Advanced Text Enhancement II, 256-Color Grayscale, and 24-Bit Color.
* Advanced Text Enhancement can clarify scanned text by processing background or foreground colors.
- **Count-Only Mode**
When operating the scanner as a stand-alone device, this mode counts the number of loaded document sheets. (See “Count Only Mode” on p. 3-21.)
- **Long Document Mode**
Document sheets up to 24.8" (630 mm) long can be scanned with Paper Size Detection. (See “User Mode Functions” on p. 4-2.)
- **Job Function**
Scanning conditions and the saving destination for image files are registered with the job, so you can scan using only control panel key operations. (See “About the Job Function” on p. 3-11.)
- **User Mode**
The User Mode functions can be employed to set the scanner for practically any condition. (See “About the User Modes” on p. 4-2.)

Detection Functions

● Auto Paper Size Detection

The document page size is detected before scanning.



Fixed-Size Scanning

Auto-Size Detection Scanning

● Text Orientation Detection

The text orientation on each page is detected, and the scanned image is rotated in 90-degree increments as necessary for normalization.



Landscape Document
(Scanned Vertically)

Image After Text
Orientation Detection

! IMPORTANT

The text orientation detection functions may not perform properly depending on the document type.

Image Processing

● Deskew

The scanner straightens an image when it recognizes from the image that the document page was fed askew.



Skewed Image

Deskewed Image

! IMPORTANT

Deskew may not function properly when scanning only specified areas of a document page.

● Dropout and Color Enhancement Functions

The scanner is equipped with drop-out and enhancement functions that enable you to specify one color (red, blue, or green) to be omitted (dropped out) or enhanced, respectively, while scanning.



Color Document

Image with Red Drop-Out
set (red filtered)

● Remove Binder Holes

Erases the shadows that appear on scanned images from binding holes on the original document.



Image with Binding Holes

Image with Binding Holes
Removed

● Skip Blank Page

The scanner scans both sides of a document and skips saving the image of any side it determines to be a blank page.



Two-Sided Documents
with a Blank Side

Images with Blank Page
Skipped

- **MultiStream Function**

The scanner supports MultiStream, which, depending on the software application, can create two images with different scanning conditions from a single scan pass. However, this function is only available when using CapturePerfect 3.0 (supplied with the scanner) or another application program that supports the Multi-Stream function.

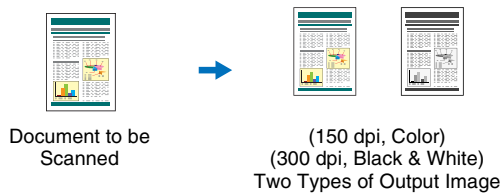

- **Patchcode Support**

Patch code sheets inserted between document pages can be detected for batch separation. (See [“Using Patchcode Sheets”](#) on p. 3-19.)

Options

- **Stamping**

This feature automatically marks the trailing edge of a scanned document page with a stamp to indicate that it has been scanned. (See [“Optional Products”](#) on p. 1-14.)

3. Names and Functions of Parts

The names and functions of the DR-7090C parts are shown below.

Feeder

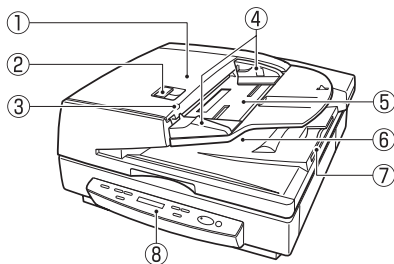

- ① Feeder Cover
Open this cover to clear document jams and clean the rollers. (See p. 3-22 and p. 5-6.)
- ② Opening Lever
Operate this release lever when opening or closing the feeder cover.
- ③ Document Set Indicator
This indicator lights when there is a document in the document feeder tray. (See p. 3-4.) When a paper jam occurs, this indicator flashes. (See p. 3-22.)
- ④ Slide Guide
Adjust this guide to the marking on the document size label that indicates the applicable document size. (See p. 3-4.)
- ⑤ Document Feeder Tray
Load documents to be scanned here. (See p. 3-4.)
- ⑥ Document Eject Tray
Scanned documents are ejected here. Open the document feeder tray to remove ejected documents. (See p. 3-5.)
- ⑦ Eject Tray Extension
- ⑧ Operation Panel (See p. 1-12.)

Flatbed

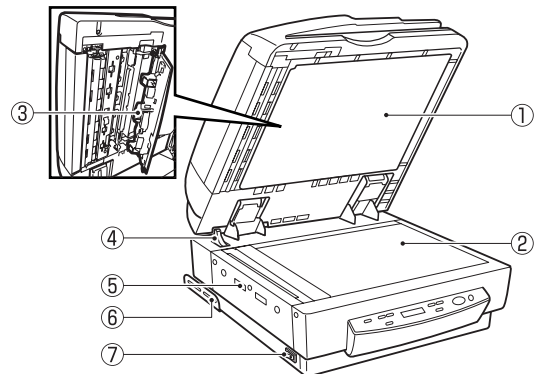

- ① Pressure Board (Black)
This board presses the document page against the glass during scanning. (See p. 3-5.)
- ② Flatbed (Platen Glass)
When placing the document onto the platen glass, align it with the arrow in the upper left corner of the glass. (See p. 3-5.)
- ③ Scanning Area Cleaning Tool
Use this when cleaning the scanning area inside the feeder. (See p. 5-9.)
- ④ Opening Sensor
This sensor detects whether the feeder is open or closed. (See p. 3-5.)
- ⑤ Air Vents
- ⑥ Securing Brace
The securing braces prevent the scanner from tipping backward when the feeder is open. (See p. 1-3.)
- ⑦ Power Switch (See p. 2-9.)

Rear

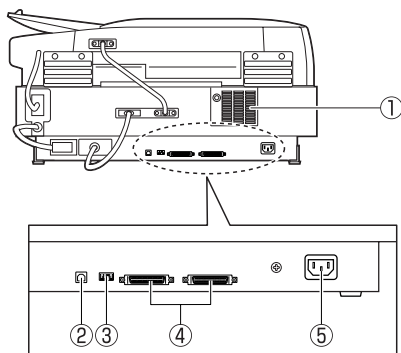

- ① Air Vents
- ② USB Connector
Connect a Hi-Speed USB 2.0 compatible USB cable here.
(See p. 2-6.)
- ③ DIP Switches
Configure these switches to specify the SCSI ID or terminator ON or OFF. (See p. 2-7.)
- ④ SCSI Connectors
Connect a SCSI cable (50-pin half pitch, pin type) here.
(See p. 2-7.)
- ⑤ Power Cord Connector
Connect the provided power cord here.

⚠ CAUTION

- Never touch the cables at the rear of the scanner. Disconnection of these cables can cause a malfunction of the scanner.
- Take care to ensure that the vents never become blocked. Blocked vents can lead to heat build-up inside of the scanner and create the risk of fire.

Operation Panel

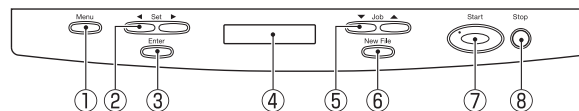

- ① Menu Key
Press this key to cycle the display through the various user modes, as shown below. (See “About the User Modes” on p. 4-2.)

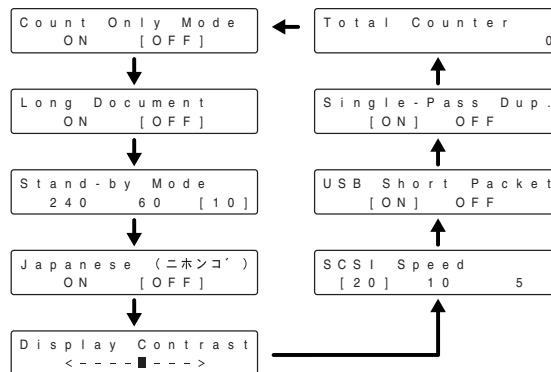

- ② Set Keys
Use these keys to change the setting of the currently displayed user mode. (See p. 4-3.)
- ③ Enter Key
Press this key to register the currently displayed user mode setting. (See p. 4-3.)
- ④ Display Panel
Displays the number of scanned pages, error codes, etc.

⑤ Job Keys

Use these keys to scroll through registered job numbers (01 through 99) on the display panel. (See “About the Job Function” on p. 3-11.) Pressing the Start key while a job number is displayed starts the scanning of the document and forwards the scanned image to the destination registered for the job.

⑥ New File Key

This key is active for applications that support batch separation. This key lights when pressed or in accordance with the application’s batch separation settings. Scanning the next document while this key is lit causes the scanned image to be stored in a different file or folder than the previously scanned document.

⑦ Start Key

The Start key lamp lights when the key is enabled by the Count Only Mode or the application’s settings. Pressing the Start key while its lamp is lit causes scanning to start.

⑧ Stop Key

Pressing this key stops an ongoing scanning operation. This key is also used to cancel a mode setting and clear an error indicator from the counter display area.

4. Optional Products

The following options can be purchased and used on the DR-7090C, if they are necessary. Contact your sales representative.

Stamp Unit

The stamp unit affixes a stamp on document pages that are scanned using the feeder. The application can be used to turn stamping on or off.

The stamp is a circle that has a diameter of about 0.1" (3 mm), with a cross in the center. It is stamped on the scanned side of the document page, approximately 0.4" (10 mm) from the trailing edge of the document page.

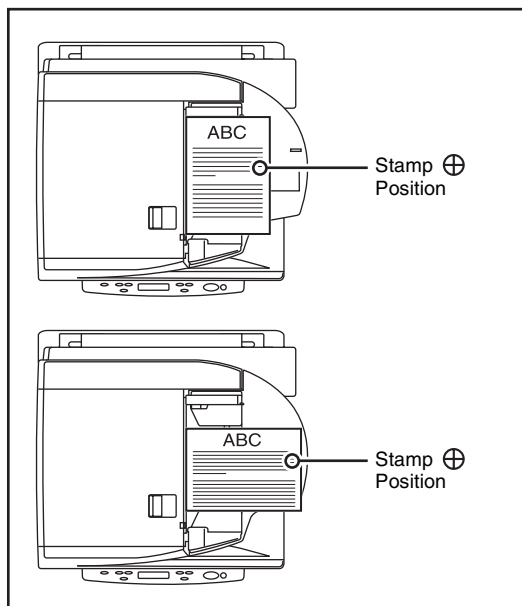

Hint

- The stamp pattern is fixed and cannot be changed.
- When scanning both sides of a document, the sides that are stamped will differ depending on the Single Pass Duplex setting of the scanner's user mode settings. When the Single Pass Duplex setting is ON, only the front side of the document is stamped. When the Single Pass Duplex setting is OFF, both sides of the document are stamped.
- The cross in the center of the stamp rotates during stamping.

Chapter 2 Setup

1. Setup Procedures	2-2
2. Installation Requirements	2-3
3. Software Installation	2-4
About the Setup Menu	2-4
4. Connecting the Scanner to the Computer	2-6
Interface Connector Locations	2-6
Using a USB Connection	2-6
Using a SCSI Connection	2-7
5. Turning the Power ON (Scanner Recognition)	2-9
About the Power Switch	2-9
Scanner Recognition	2-9

1. Setup Procedures

Perform the following setup procedures to prepare the scanner for use.

Step 1: Confirm the installation requirements. (See p. 2-3)

Step 2: Install the Software. (See p. 2-4)

Step 3: Connect the scanner to the computer. (See p. 2-6)

Step 4: Turn the power ON (Scanner recognition). (See p. 2-9)

! IMPORTANT

- Be sure to install the software before connecting the scanner to the computer.
- If you connect the scanner to the computer before installing the software, a wizard screen such as the one shown below will appear when you turn the scanner ON. In this case, click [Cancel] to close the wizard screen, and then turn the scanner OFF.
- Windows 2000

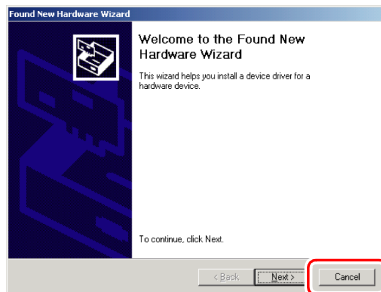

- Windows XP

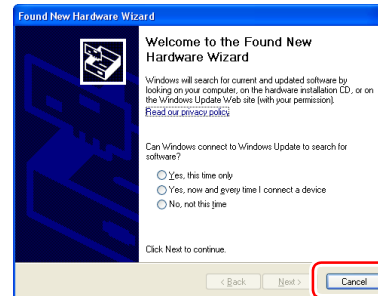

- Windows Vista

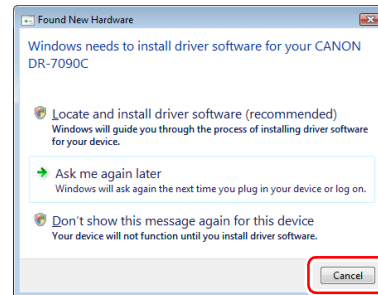

2. Installation Requirements

To use the DR-7090C, your computer must satisfy the following system requirements.

■ Operating System:

- Microsoft Windows 2000 Professional SP4 or later
- Microsoft Windows XP Professional SP3 or later
- Microsoft Windows XP Home Edition SP3 or later
- Microsoft Windows XP Professional x64 Edition SP2 or later
- Microsoft Windows Vista Home basic, Home Premium, Business, Ultimate or Enterprise SP1 or later



Hint

Microsoft Windows Vista has 32- and 64-bit versions.

■ Computer Specifications:

- CPU: Pentium 4, 3.2GHz or faster
- Memory: 1 GB or more
- Hard disk: 1 GB or more available space
- CD-ROM drive
- Interface: One standard Hi-Speed USB 2.0 port on the PC, or a SCSI expansion card
- Monitor: Resolution of 1024 × 768 (XGA) or better recommended

■ Recommended SCSI Cards:

SCSI cards made by Adaptec (for PCI bus)

- AHA-2930U
- AHA-2940AU
- ASC-19160

SCSI card made by Adaptec (for Card bus)

- APA-1480

■ An ISIS-compatible application or a TWAIN-compatible application that is compatible with the above operating systems.

! IMPORTANT

- If you do not know the requirements for your computer system, contact the store where you purchased the computer or the manufacturer of the computer for more information.
- Do not connect both a USB interface and a SCSI card at the same time.
- Note the following points when using the USB interface that was provided with your computer.
 - The USB connection should be a Hi-Speed USB 2.0 interface.
 - Scanning speeds are lower if your computer's standard USB interface is USB Full-Speed (equal to USB 1.1).
 - Use the most recently available USB 2.0 driver provided by Microsoft. Contact your local authorized Canon dealer for more detailed information.
 - Not all USB interfaces provided as standard with personal computers are guaranteed. Contact your local authorized Canon dealer for more detailed information.
 - Use the USB cable that was originally bundled with the scanner or a Hi-Speed USB 2.0 compatible cable.
- Note the following when using a SCSI card.
 - Make sure to follow the procedure in the manual for the SCSI card and the computer that you are using when installing a SCSI card in your computer.
 - The overall length of the SCSI cable you can use is determined by the SCSI standards. Refer to the manual for the SCSI card you are using for more information.
- If the CPU, memory, interface card, and other specifications do not satisfy the installation requirements, the scanning speed may be greatly reduced and transmission may take a long time.
- Even if the computer satisfies the recommended specifications, the scanning speed may vary, depending on the scan settings.
- The ISIS/TWAIN Drivers provided with the scanner do not necessarily operate on all ISIS- or TWAIN-compatible applications. For details, contact your application software retailer.

3. Software Installation

This section describes how to install the software.

About the Setup Menu

When you insert the included Setup disc into the computer's CD drive, the menu shown below should appear. If the menu does not appear, use Explorer to access the CD drive and execute the file "SETUP.EXE".

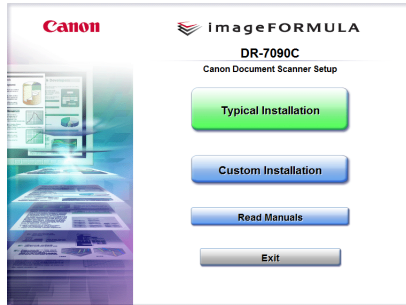

! IMPORTANT

- As always when installing software, log in using an account with Administrator privileges.
- When using Windows Vista, the "User Account Control" dialog box may appear. In this case, enter your login user password for Administrator privileges, and click [OK].

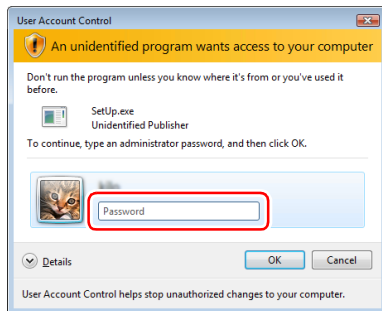

■ The Typical Installation Screen

This screen appears when you click "Typical Installation" on the Menu screen. Click [Install] to install all of the listed software.

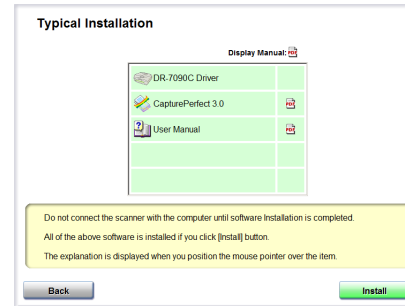

💡 Hint

See the *Easy Start Guide* for instructions on using the typical installation procedure.

■ The Custom Installation Screen

This screen appears when you click “Custom Installation” on the Menu screen. Select the check boxes next to the software that you want to install.

Click [Install] to install the selected software.

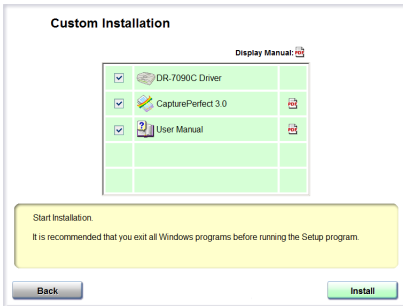

■ The Read Manual Screen

From this screen you can select one of the supplied electronic manuals to read: the *Easy Start Guide* (a printed copy is also supplied), the *Reference Guide*, the *User Manual* (this manual), or the *CapturePerfect 3.0 Operation Guide*.

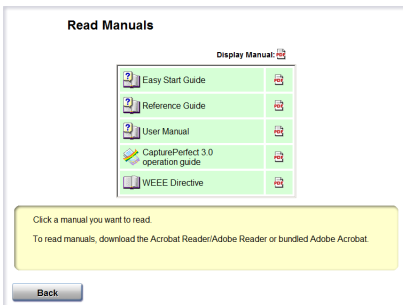

4. Connecting the Scanner to the Computer

There are two methods for connecting the DR-7090C scanner to a computer: a USB connection to a standard USB port built in to the computer, or SCSI connection to a SCSI card installed in an expansion slot of the computer. Select the method that is best suited to your computer environment.

Interface Connector Locations

The USB port and SCSI connector are located on the scanner as shown below.

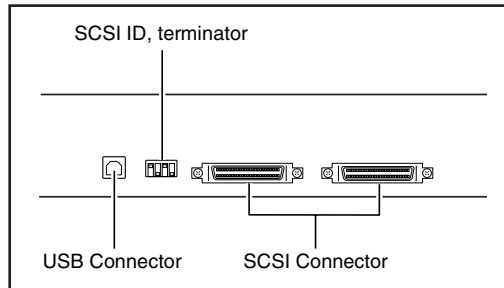

! IMPORTANT

- Do not connect both USB and SCSI cables to the scanner at the same time.
- Use only the supplied power cord.
- The scanner and computer should both be turned OFF when making connections.
- Make sure that the computer is turned OFF before connecting the SCSI cable. The scanner may not be properly recognized by the computer if it is connected while the computer is turned ON.
- A SCSI cable is not supplied with the scanner. Obtain a cable with connectors that match the SCSI connectors on both the scanner and the computer.

Using a USB Connection

1. Connect the supplied power cord into the power connector on the back of the scanner. ①

2. Connect the power cord into an AC outlet. ②

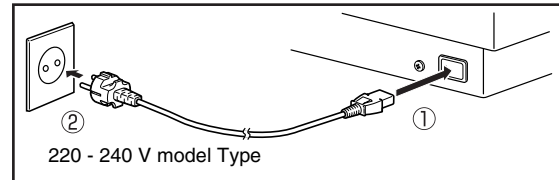
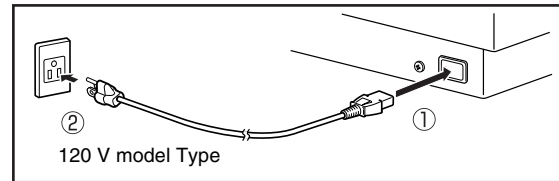

3. Use the supplied USB cable to connect the scanner to the computer.

Connect the square plug (Type B) of the USB cable to the scanner.

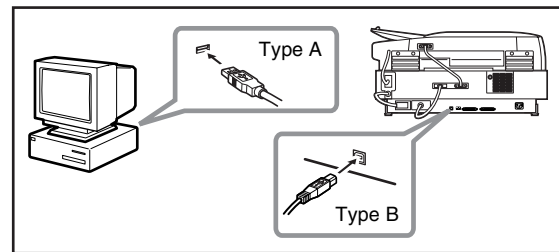

! WARNING

When using a USB connection, make sure to set the SCSI terminator to ON. If the SCSI terminator is set to OFF, proper scanning may not be possible.

Using a SCSI Connection

! IMPORTANT

Make sure that the computer is turned OFF before connecting the SCSI cable. If the cable is connected while the computer is on, the scanner may not be properly recognized by the computer.

1. Shut down Windows and turn the computer's power OFF.
2. Connect the supplied power cord into the power connector on the back of the scanner. ①
3. Connect the power cord into an AC outlet. ②

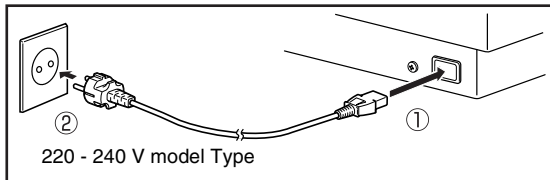
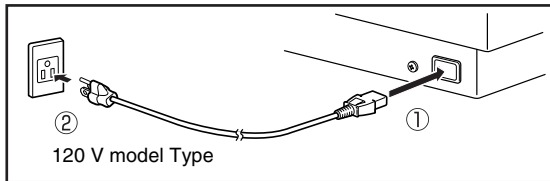

4. Use the SCSI cable to connect the scanner to the computer.

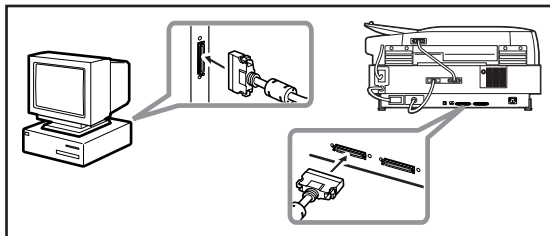

■ Setting the SCSI ID and terminator

Set the SCSI ID and terminator using the DIP switches located between the SCSI connectors and power cord connector.

Slide a DIP switch up to set it OFF, and slide it down to set it ON.

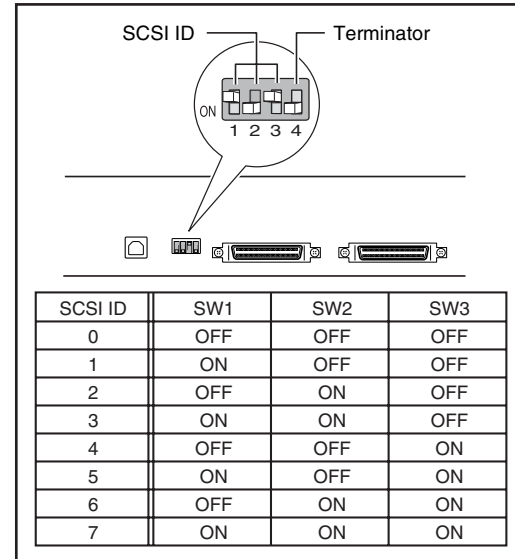

Refer to the table when setting the SCSI ID. If other SCSI devices are connected to or built into the computer, make sure that none of the SCSI IDs overlap.

! IMPORTANT

- The SCSI ID is factory set to 2.
- You can set the SCSI ID between 0 and 7. However, do not use ID 7 as this ID is usually assigned to the SCSI controller. In addition, when the SCSI hard disk drive is built in, do not use IDs 0 and 1 as these IDs are usually assigned to the hard disk.

Set the terminator on the last SCSI device in the daisy chain connection to ON.

<When only the scanner is connected to your computer, or when the scanner is the last device in a daisy chain>

Set the terminator switch to ON.

In such a connection, make sure that the terminators on all other SCSI devices are set to OFF.

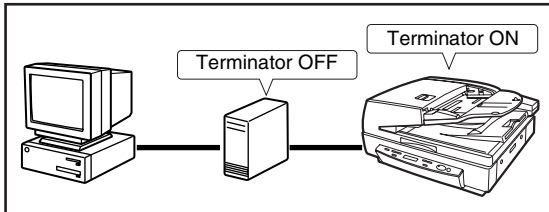

<When another SCSI device is the last device in a daisy chain>

Set the terminator switch on the scanner to OFF.

In such a connection, set the terminator on the last connected SCSI device to ON.

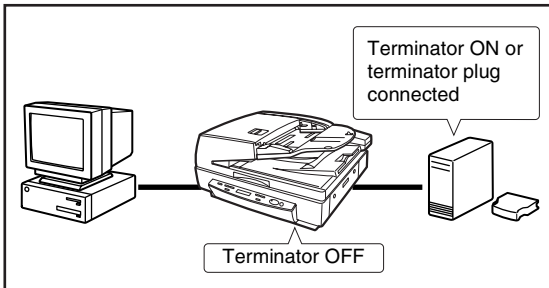

⚠ CAUTION

When the scanner is the last device connected in a daisy chain, make sure to set the terminator using either the DIP switch or a terminator plug. If you use a terminator plug and the DIP switch is set to ON, the scanner may malfunction.

5. Turning the Power ON (Scanner Recognition)

When you turn ON the computer and the scanner, the Windows Plug and Play function recognizes the scanner and automatically installs the required device driver.

About the Power Switch

The power switch is located on the scanner's side panel, and the following appears on the display panel when the power switch is turned ON. (See p. 6-2.)

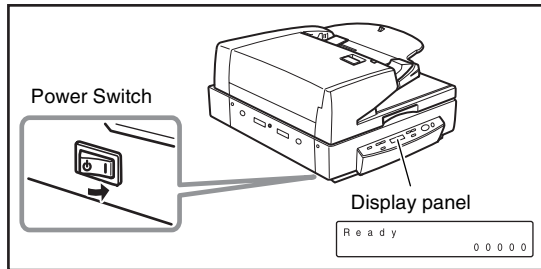

! IMPORTANT

- When connecting the scanner to the computer using a SCSI cable, be sure to turn ON the scanner first, and then turn ON the computer. If you turn ON the computer first, the scanner may not be properly recognized by the computer.
- Press the power switch again to turn the scanner OFF.
- After turning the scanner OFF, wait at least 10 seconds before turning it ON again.
- If you will not be using the scanner for an extended period, disconnect the power cord from the AC outlet for safety.

Scanner Recognition

The scanner will be recognized the first time it is connected to the computer.

1. Make sure that the scanner and computer are connected properly.
2. Turn ON the scanner.
3. Turn ON the computer.
4. Log on to Windows as an Administrator.
5. Windows automatically recognizes the scanner and performs the device driver installation.

- Windows 2000

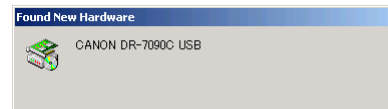

- Windows XP



- Windows Vista

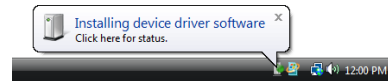

 **Hint**

- With Windows Vista, installation proceeds automatically regardless of the displayed “Check here for status” balloon help. You can click “Check here for status” to display the installation progress.

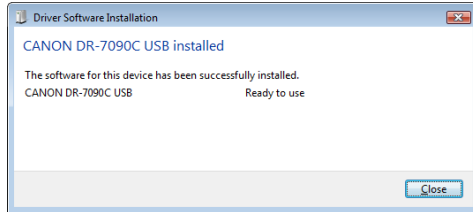

- With Windows XP and Vista, a message appears when installation is finished.
- Windows XP

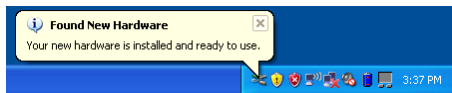

- Windows Vista



- The DR-7090C device driver is installed in Device Manager under [Imaging Devices] as [CANON DR-7090C USB] or [CANON DR-7090C SCSI].

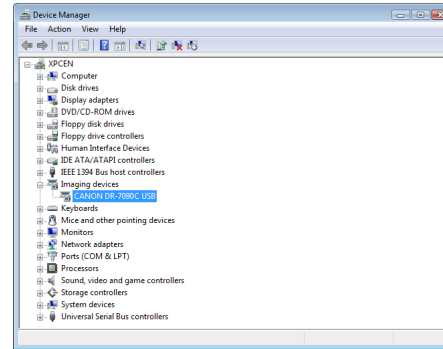

- From the Control Panel, you can display the Device Manager using the following procedure:
 - With Windows 2000, open [System] and click [Device Manager] on the Hardware tab sheet.
 - With Windows XP, first switch the Control Panel to the Classic View to display [System]. Then open [System] and click [Device Manager] on the Hardware tab sheet.
 - With Windows Vista, open [System Maintenance] and click [Device Manager]. Or, switch the Control Panel to the Classic View and click the [Device Manager] icon.

Chapter 3 Basic Operation

1. Documents.....	3-2
Types of Documents	3-2
Feeder Capacity.....	3-3
2. Placing Documents onto the Scanner	3-4
Loading a Document into the Feeder.....	3-4
Positioning a Document on the Flatbed (Platen Glass)	3-5
3. Document Feeding	3-8
Scan Procedure	3-8
4. Scanning.....	3-11
About the Job Function	3-11
CapturePerfect 3.0.....	3-14
5. Using Patchcode Sheets	3-19
About Patchcode Sheets.....	3-19
How to Use Patchcode Sheets	3-20
6. Count Only Mode.....	3-21
7. Clearing Paper Jams	3-22
Clearing a Paper Jam	3-22
Paper Jam Causes.....	3-24

1. Documents

This section describes the various types of documents that can be scanned with the feeder.

CAUTION

Handle documents with care. Improper handling of paper can cause paper cuts or other personal injury.

Types of Documents

The following are the dimensions of the documents that can be fed by the feeder:

Width: 5.5" to 11.7" (139.7 mm to 298.1 mm)

Length: 5" to 17" (128 mm to 431.8 mm) (Normal Mode)
5" to 24.8" (128 mm to 630 mm) (Long Document Mode)

Document Thickness

Black-and-white Documents

Simplex: 0.002" to 0.006" (0.06 mm to 0.15 mm)

Duplex: 0.002" to 0.006" (0.07 mm to 0.15 mm)

Black-and-white/Color Documents Mixed: 0.002" to 0.006" (0.07 mm to 0.15 mm)

Color Documents

0.003" to 0.006" (0.08 mm to 0.15 mm)

Documents Longer than 17" (432 mm)

0.003" to 0.006" (0.08 mm to 0.14 mm)

Document Weight

Black-and-white Documents

Simplex: 11 to 32 lb bond (42 to 128 g/m²)

Duplex: 13 to 32 lb bond (50 to 128 g/m²)

Black-and-white/Color Documents Mixed: 13 to 32 lb bond (50 to 128 g/m²)

Color Documents

17 to 32 lb bond (64 to 128 g/m²)

Documents Longer than 17" (432 mm)

16 to 24 lb bond (60 to 90 g/m²)

Follow these guidelines when you prepare a document for scanning:

- When scanning long documents, set Long Document mode to ON in the user mode settings, and then scan the documents one by one. (See "About the User Modes" on p. 4-2.)
- Before scanning documents that contain pasted artwork, make sure that the ink or paste on the pages is thoroughly dry. If the documents are scanned with the ink or paste still wet, the scanner may malfunction.
- If you scan a document written in pencil, the letters may not scan properly or the pencil may rub off onto the rollers and stain subsequent documents. Before you scan this kind of document, make a copy and then scan the copy. After scanning a document written in pencil or some other soft writing material, be sure to clean the scanning rollers. (See "Cleaning the Feeder" on p. 5-6.)
- If you scan thin paper in the Duplex mode, the ink printed on the back side may be scanned. In this case, adjust the scanning density.
- If you scan documents with a rough surface, friction between the documents may cause a paper jam. In this case, select [Flatbed], and then scan the documents one page at a time.
- When you scan a batch of NCR documents, make sure that they are not stuck together. If a jam occurs, change the scanning side setting to 'Flatbed', and then scan the document one page at a time.

- To avoid paper jams, damage to documents, and a scanner malfunction, do not feed the following types of paper. For such documents, scan one page at a time from the flatbed (platen glass).



Wrinkled or creased paper



Curled paper



Torn paper



Paper with clips or staples



Carbon-backed paper



Coated paper



Extremely thin paper



Hint

- Note that mixing documents of different thicknesses and sizes may cause a malfunction during feeding.
- Documents containing text or pictures within 0.2" (5 mm) of its edges or documents with a color background may cause erroneous skew detection or automatic size detection.

Feeder Capacity

Note the following rules when loading a document into the feeder.

- Make sure the top of the document stack is not higher than the load limitation mark. Overloading the feeder can cause jamming.
- The feeder is designed to hold approximately 100 sheets of standard copy paper (20 lb bond or 80 g/m²).

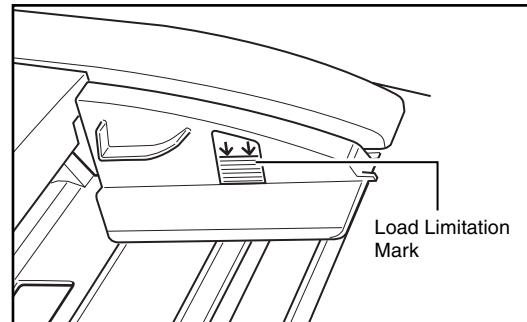

2. Placing Documents onto the Scanner

This section describes how to load documents into the feeder and how to position a document page on the flatbed (platen glass) for scanning.

CAUTION

Handle documents with care. Improper handling of paper can cause paper cuts or other personal injury.

Loading a Document into the Feeder

Perform the following steps to load the pages of a document into the feeder for scanning.

1. Adjust each slide guide so its pointer is aligned with the corresponding paper size on the document size label.

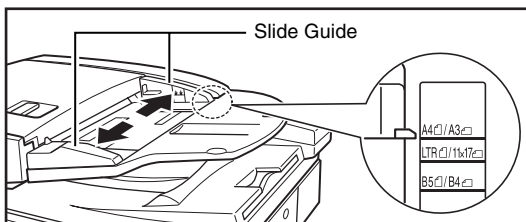

IMPORTANT

Use both hands to adjust both the left and right slide guides. Adjusting only one slide guide can lead to a malfunction.

2. Align the edges of the document stack on a flat surface, and then load the stack into the feeder with the scanning side facing upwards. Insert the stack into the feeder as far as it will go, until the document set indicator lights.

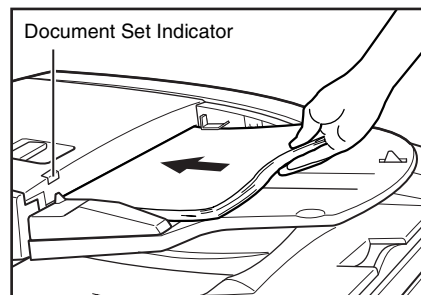

IMPORTANT

- Make sure the top of the document stack is not higher than the load limitation mark. Overloading the feeder can cause jamming.
- The feeder is designed to hold approximately 100 sheets of standard copy paper (20 lb bond or 80g/m²).

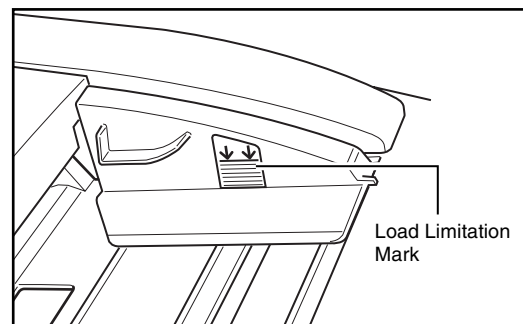

- When scanning NCR paper that is 11" x 17"/A3 or other large sizes, as well as paper that is very thin, the document may occasionally get caught in the paper eject mechanism. In this case, place an auxiliary sheet of paper in the document eject tray before scanning the document.

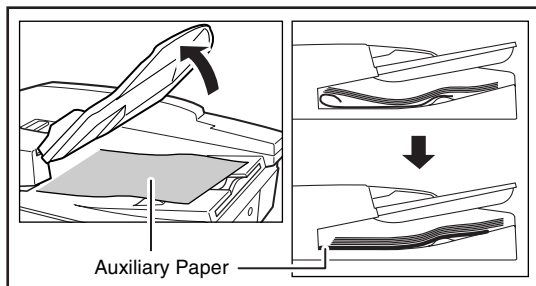

- After scanning is complete, lift the document feeder tray, and then remove the document from the document eject tray.

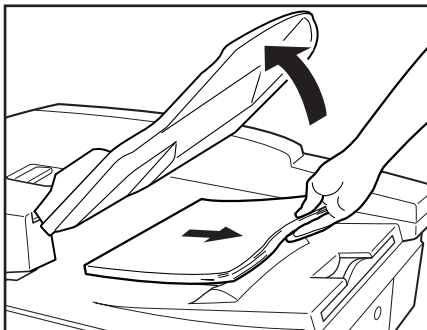

! IMPORTANT

- Leaving a document in the document eject tray and scanning another document can cause jamming.
- Raise the document feeder tray only as much as you need to remove the ejected document pages. Trying to forcibly raise the document feeder tray can cause a malfunction.

Positioning a Document on the Flatbed (Platen Glass)

Use the following procedure to scan on the flatbed (platen glass) when scanning a book, thick document, very thin document, OHP (overhead transparency) or any other document that cannot be scanned using the feeder.

- Open the feeder.

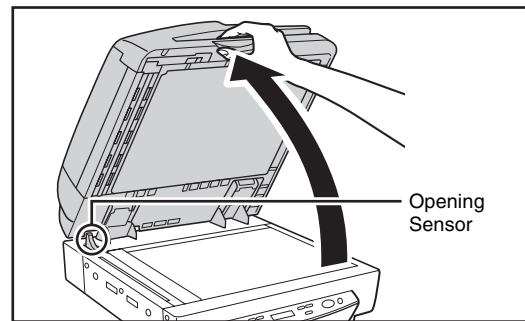

! IMPORTANT

- Lower the feeder slowly, taking care to avoid pinching your fingers. Failure to do so might result in personal injury.
- When scanning on the flatbed (platen glass), open the feeder at least 11.8" (300 mm) until the opening sensor unit is disengaged.

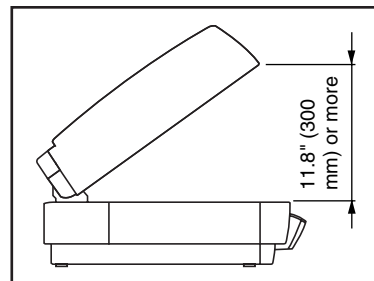

2. Place the document onto the flatbed (platen glass) with the scanning side facing downwards.

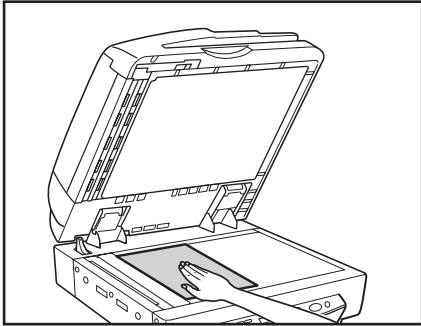

With the scanning side of the document facing downwards, align its corner with the arrow mark in the upper left corner of the flatbed (platen glass).

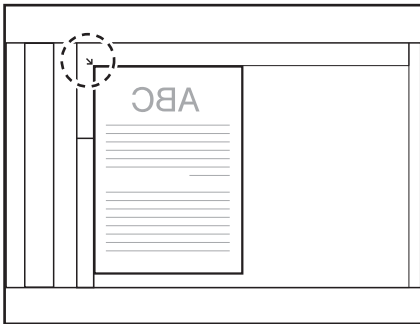

3. Slowly and carefully lower the feeder back down.

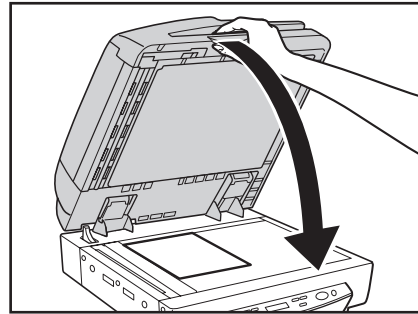

⚠ CAUTION

- Lower the feeder slowly, taking care to avoid pinching your fingers. Failure to do so might result in personal injury.
- When scanning a thick book or similar item on the flatbed (platen glass), avoid pressing down hard on the feeder. Doing so might damage the glass and create the risk of malfunction or personal injury.

4. Open the feeder and remove the document from the flatbed (platen glass).

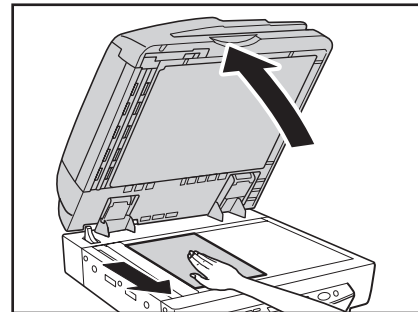

! IMPORTANT

Open the feeder carefully and slowly, taking care to avoid letting the feeder fall over backwards.

 **Hint**

Leave the feeder raised when scanning thick documents like books, or operate the feeder as shown in the procedure below.

1. Open the feeder.
2. While pressing on the bottom of the feeder ①, pull the feeder down and forward ②.

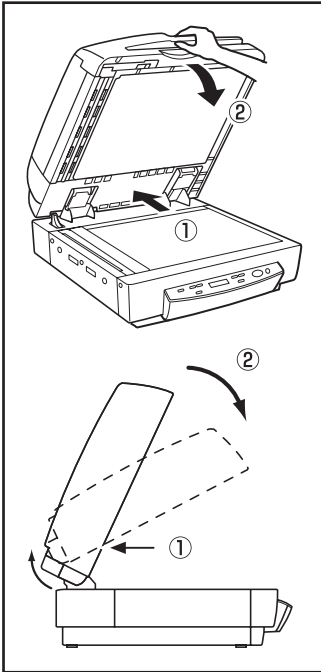

3. Set the thick document or book on the flatbed (platen glass) and hold the feeder lightly while scanning.

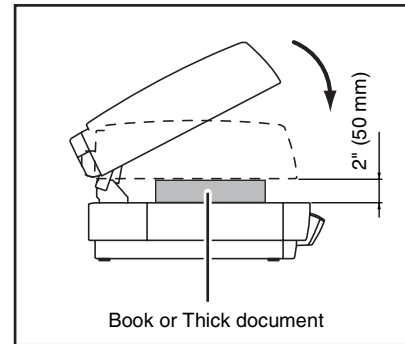

4. To return the feeder to its original position, open it all the way ①, then close it carefully and slowly ②.

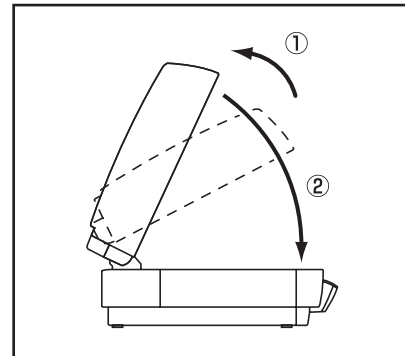

3. Document Feeding

This section describes the various different document feeding modes that are available, and the basic steps to use each mode for scanning.

CAUTION

- Avoid wearing loose fitting clothing, dangling jewelry, long ties, or even long hair that could become entangled with moving parts, especially the rollers that feed the paper. If such objects become entangled, immediately disconnect the power plug from the power outlet to stop the scanner.
- Check the stack and remove all clips, staples, pins, or any other type of metal or plastic fastener. They may damage the document, cause a paper jam, or scanner malfunction.
- Do not open the feeder cover during scanning. This could damage the document, cause document jams, or damage the scanner.

Scan Procedure

The Feeding Option setting (see p. 8-16) in the scanner settings screen allows you to select from among the three feeding modes described below. The procedure you should use depends on the currently selected feeding mode.

Standard Feeding (See p. 3-8)

With this mode, you start and stop scanning from an application on your computer. After placing the document onto the scanner, instruct the scanner from your computer to start scanning.

Panel Feeding (See p. 3-9)

Panel feeding comes in handy when using the feeder for continuous scanning, for scanning page-by-page from a book, etc. After placing the document page onto the scanner, press Start to start scanning.

When scanning is complete, place the next document page onto the scanner, and then press Start again.

Automatic Feeding (See p. 3-10)

Use this mode for scanning a stack of document pages with the feeder. The scanner will start scanning automatically when it detects a document in the document feeder tray. Scanning stops when the document feeder tray is empty. Loading the next document into the document feeder tray restarts scanning.

Hint

- To scan using the flatbed, set the scanning side to [Flatbed] or [Auto] in the scanner settings screen.
- If the scanning side is set to [Auto] in the scanner settings screen, documents placed in the feeder will be scanned. If there are no documents in the feeder, the flatbed will be scanned.

■ Standard Feeding

To use the standard feeding mode, instruct the scanner to start from the application.

1. Select [Standard Feeding] in [Feeding Option] on the scanner settings screen.
2. Place the document onto the scanner.

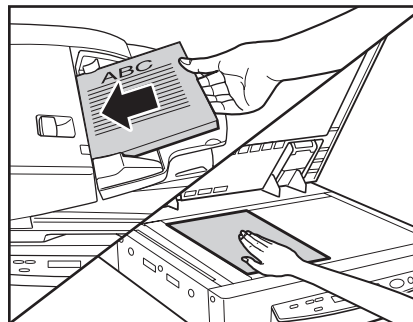

! IMPORTANT

See “Placing Documents onto the Scanner” on p. 3-4 for information about placing documents onto the scanner.

- From the application you are using, execute the required command to start scanning. Scanning starts.
- When scanning of the document is complete, the application goes into the Ready Mode.

💡 Hint

If paper feeding stops during scanning due to a system error or paper jam, make sure that the last page of the document was recorded properly before continuing to scan.

- If you want to scan another document, place it onto the scanner, and then execute the required command from the application to resume scanning. To finish scanning, execute the required command from the application.

! IMPORTANT

If you are using the feeder for scanning, be sure to remove ejected document pages from the document eject tray before scanning another document. Leaving a document in the document eject tray and scanning another document can cause a paper jam.

■ Panel Feeding

With panel feeding, you execute the scan command from your application, and then use the scanner’s Start and Stop keys to control the scanning operation.

- Select [Panel-Feeding] in [Feeding Option] on the scanner settings screen.
- From the application you are using, execute the required command to start scanning. The Start key lamp to lights green.

- Place the document onto the scanner.

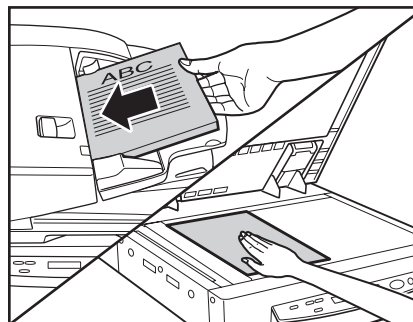
**! IMPORTANT**

See “Placing Documents onto the Scanner” on p. 3-4 for information about placing documents onto the scanner.

- Press Start.
- When scanning of the document is complete, the scanner goes into the Ready Mode.

💡 Hint

If paper feeding stops during scanning due to a system error or paper jam, make sure that the last page of the document was recorded properly before continuing to scan.

- If you want to scan another document, place it onto the scanner, and then press Start to resume scanning. To finish scanning, press Stop.

! IMPORTANT

If you are using the feeder for scanning, be sure to remove ejected document pages from the document eject tray before scanning another document. Leaving a document in the document eject tray and scanning another document can cause a paper jam.

■ Automatic Feeding

Automatic feeding can be used when feeding a document from the feeder. After you execute the scan start command from the application, the scanner starts scanning automatically whenever it detects a document loaded into the feeder.

1. Select [Automatic Feeding] in [Feeding Option] on the scanner settings screen.
2. From your application, execute the command to start scanning.
The Start key lamp lights green.
3. Load the document into the document feeder tray.

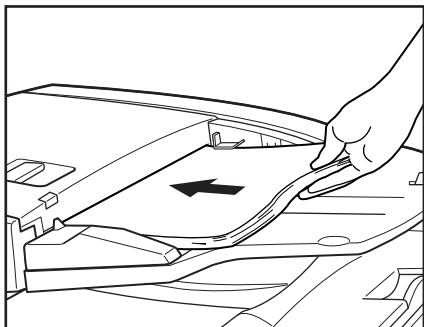

The scanner detects the documents, and scanning starts.

! IMPORTANT

See “Placing Documents onto the Scanner” on p. 3-4 for information about placing documents onto the scanner.

4. When scanning of the document is complete, the scanner goes into the Ready Mode.
5. Raise the document feeder tray to remove the ejected document pages.

! IMPORTANT

Make sure to remove ejected document pages from the document eject tray before scanning another document. Leaving a document in the document eject tray and scanning another document can cause a paper jam.

6. Loading another document into the document feeder tray causes scanning to start automatically. After you finish scanning, press Stop.

💡 Hint

If the scanning side is set to [Auto] and the feeding option is set to [Automatic Feeding], scanning is performed as follows.

- Documents are automatically detected and scanned when placed in the feeder.
- The Start key lamp lights, and the flatbed enters a standby state. If you place a document on the flatbed and press the Start key, the document on the flatbed will be scanned.

4. Scanning

Scanning operations can be controlled by a scanning application program such as the CapturePerfect 3.0 software included with the scanner, or directly from the control panel of the DR-7090C, using the Job Function.

This section describes the Job Function and provides an overview of CapturePerfect 3.0.

! IMPORTANT

When the conditions for scanning require a large amount of the computer's memory, scanning may not be possible if the memory is insufficient. If a memory error appears during scanning, exit the application and change the scanning conditions before attempting to scan again. (See "Before Use" on p. 8-2.)

About the Job Function

The Job Function enables you to use the Job Registration Tool to register different jobs which can then be selected for scanning by pressing the Job key on the control panel. Job registration stores scanning condition settings, image file format selection, save destination, and image data processing settings for each job to be used with the Job Function.

💡 Hint

The Job Registration Tool is a TWAIN-compliant application that is installed along with the ISIS/TWAIN driver. See [Chapter 9 "Job Registration Tool Settings"](#) for details.

The Job function has the capabilities listed below, and jobs can be registered using the Job Registration Tool.

- Images can be saved to a shared folder or other specified folder.
- Images can be sent as e-mail attachments (e-mail application not required).
- Images can be output to a specified printer.

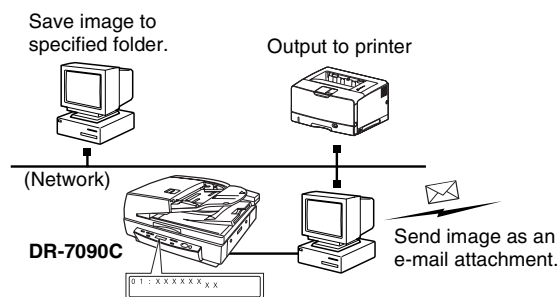

■ Executing Jobs

Use the following procedure to execute jobs that have been registered by the Job Registration Tool.

1. Set the Events function. (See "Setting the Events Function" on p. 3-13.)
2. From the Windows task bar, click [Start] → click [All Programs] → [Canon DR-7090C] → [Job Registration Tool].

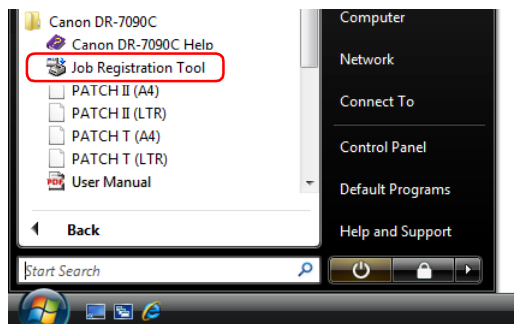

Job Registration Tool starts.

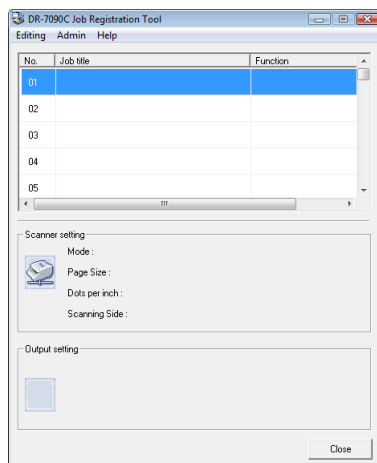

- Use Job Registration Tool to register a job.



Hint

For details on how to register jobs with Job Registration Tool, see [Chapter 9 "Job Registration Tool Settings"](#).

- Press the Job [\blacktriangle] key to enter the Job Mode.
The job number screen appears on the display panel.

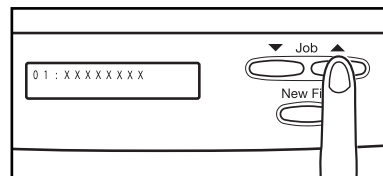

- Press the Job [\blacktriangle] and [\blacktriangledown] keys to select a job number (01 to 99).
- Place the document onto the scanner.

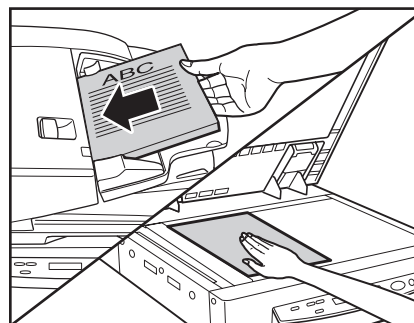

! IMPORTANT

For details on how to place documents, see ["Placing Documents onto the Scanner"](#) on p. 3-4.

- Press the Start key.
The image file is forwarded in accordance with the selected job.
- When scanning of the document is complete, press the Stop key to exit the Job Mode.



Hint

If the Job Mode is not operating correctly, see ["Troubleshooting"](#) on p. 6-5.

■ Setting the Events Function

The Job function will not function unless [DR7090C Job Tool] is specified for the scanner's Events function in Windows. Before using the Job function, perform the following procedure to configure the scanner's event settings.

1. Click the [Start] button, then select [Settings] - [Control Panel].

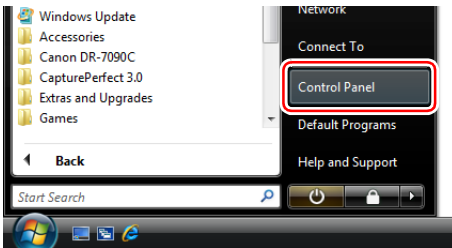

2. Double-click [Scanners and Cameras].

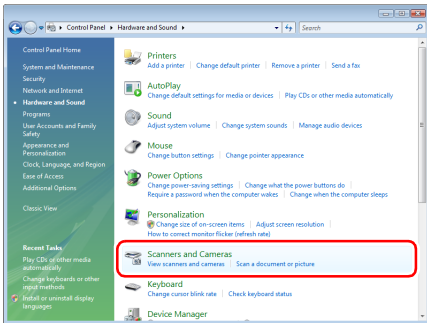

The Scanners and Cameras dialog box appears.



Hint

The dialog box that appears may vary depending on the Windows version you are using.

3. Select [Canon DR-7090C] and click [Properties].

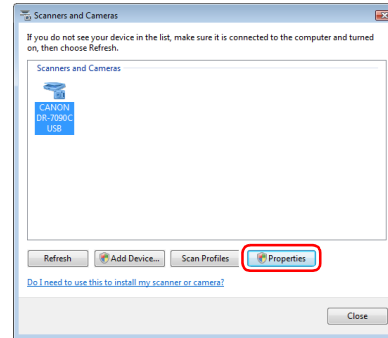

4. Click the [Events] tab.

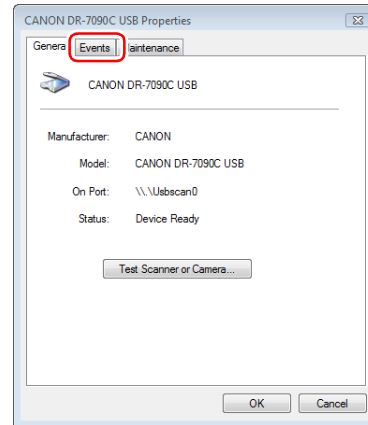

5. Select [Job Start Button] under [Scanner events].

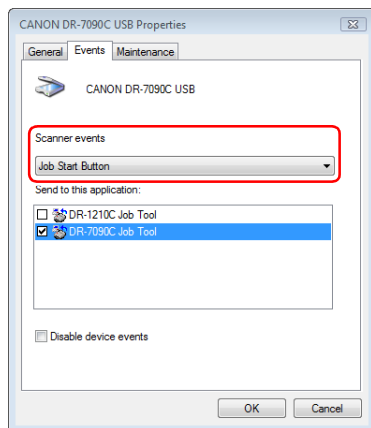

6. Clear all the check boxes under [Send to this application] except for the [DR-7090C Job Tool] check box.
7. Click [Apply].

! IMPORTANT

You cannot use the Job function if the [Disable device events] check box is selected.

8. Click [OK].
9. Restart Windows.

CapturePerfect 3.0

CapturePerfect 3.0 is an ISIS-compatible application developed for Canon document scanners.

CapturePerfect 3.0 includes the following modes. Select the desired scan mode from the Scan menu to perform scanning. For more information on CapturePerfect 3.0, refer to the *CapturePerfect 3.0 Operation Guide*.

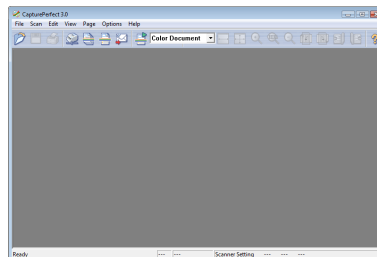

■ Scanning with CapturePerfect

The following three scanning methods are available from the CapturePerfect Scan menu.

Scan Batch to Printer

Prints scanned images on a specified printer

Scan Batch to File

Saves scanned images as files in a specified folder



(Network)

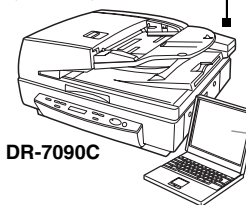

Scan Batch to Mail

Starts your e-mail program and attaches the scanned image to a new e-mail message

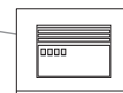

Scan Batch to File

Documents are scanned with the preset scanning conditions, and the scanned image data is saved to a specified folder.

Scan Batch to Printer

Documents are scanned with the preset scanning conditions, and the scanned image data is printed on a specified printer.

Scan Batch to Mail

Scanning is performed with the specified scanning conditions, and a MAPI-compliant e-mail client is started to generate a new e-mail message with the scanned images as attachments.

Scan Page

Only one page of the document is scanned.

Scan Job

The scanning conditions and scan mode (Scan Batch to File, Scan Batch to Printer, or Scan Batch to Mail) are registered in advance as a job. The scan job can then be performed by selecting the registered job from the drop-down list (①) or by clicking (Scan Job) on the toolbar (②).

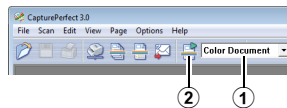

Hint

The following two scan jobs are already registered and up to 99 additional jobs can be registered.

- Color Document
Scan the document using 24-bit color, simplex, at 300 dpi resolution, and save the file in the folder [My Pictures] under the folder [My Documents].
- Binary Document
Scan the document in black-and-white, simplex, at 200 dpi resolution, and save the file in the folder [My Pictures] under the folder [My Documents].

Scan To Presentation

This mode is useful when a compact scanner is used in an environment such as a conference hall, where it is connected to a large display or projector. By setting CapturePerfect for full-screen display before scanning, scanned images are displayed at full size on the screen.

Hint

This is not usually practical for large scanners such as the DR-7090C.

■ Using CapturePerfect 3.0

This section describes how to start CapturePerfect 3.0 and scan documents. The procedure for using the Scan Batch to File function is described here as an example. For details, refer to the *CapturePerfect 3.0 Operation Guide*.

1. From the Windows task bar, click [Start] → click [All Programs] → [CapturePerfect 3.0] → [CapturePerfect 3.0].

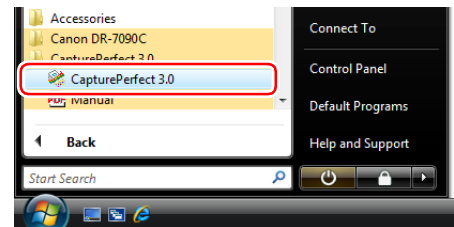

CapturePerfect 3.0 starts.

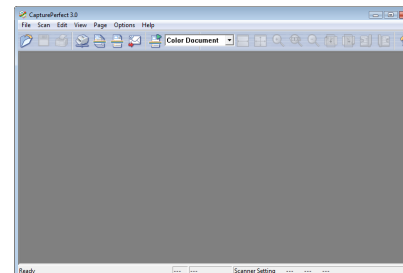

2. From the [Scan] menu, select [Select Scanner].

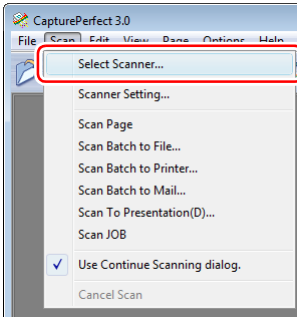

The [Select Scanner] dialog box opens.

3. Select [Canon DR-7090C] and click [Settings].

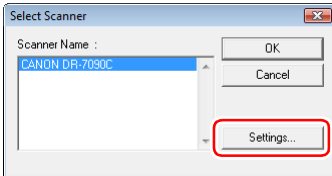

The [Configure Device Settings] dialog box opens.

! IMPORTANT

If [Canon DR-7090C] is not displayed in [Scanner Name], you must re-install the ISIS/TWAIN driver.

4. Set the [Default Page Size].

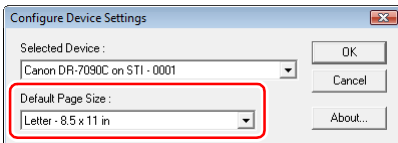

! IMPORTANT

If you select [Default] in the ISIS driver properties dialog box, that setting is applied here.

5. Click [OK] to finish scanner selection.

6. From the [Scan] menu, select [Scan Batch to File].

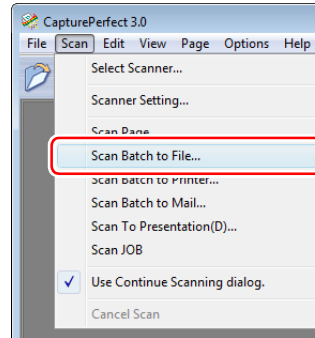

The [Scan Batch to File Setting] dialog box opens.

7. Click [Scanner Setting].

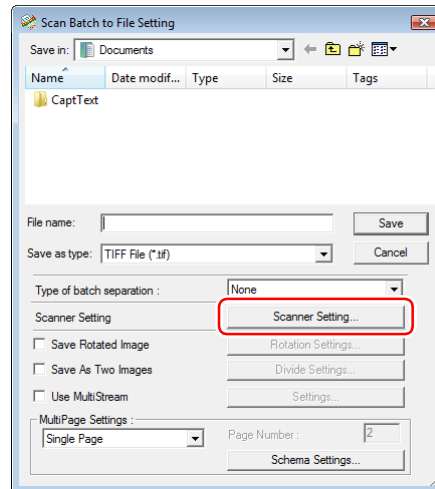

The Properties dialog box for the scanner driver opens.

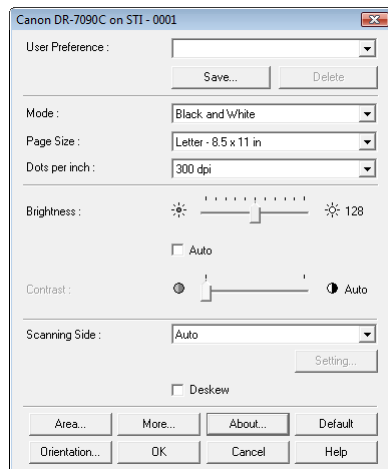

8. Set the scan settings. (See “ISIS/TWAIN Driver Settings Dialog Boxes” on p. 8-4.)

Hint

- To scan using the flatbed, set the scanning side to [Flatbed] or [Auto].
- If the scanning side is set to [Auto], documents placed in the feeder tray will be scanned. If there are no documents in the feeder tray, the flatbed will be scanned.

9. Specify the file name and the file type for saving the image data.

For details on the available settings in the [Scan Batch to File Setting] dialog box, refer to the *CapturePerfect 3.0 Operation Guide*.

10. Place your document and click [Save] to start scanning.

IMPORTANT

You must load your documents as described below, depending on the specified [Scanning Side] and [Feeding Option] settings.

- If the [Standard Feeding] Feed Option is enabled, load your documents before scanning. When all of the documents have been scanned, the Continue Scanning dialog box appears.

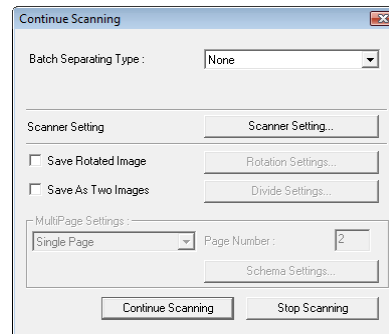

- If a Feed Option other than [Standard Feeding] or [Manual Feeding] is selected, once you have started scanning, each document placed in the Document Feed Tray is scanned, and when no document is loaded, the scanner enters the standby state.
- If the [Automatic Feeding] Feed Option is enabled, scanning is performed automatically whenever a sensor in the Document Feed Tray detects a loaded document, and pressing the Stop key causes the Continue Scanning dialog box to appear.
- If the [Panel-Feeding] Feed Option is enabled, the Start key lamp is lit. You must load a document and press the Start key to scan. Pressing the Stop button causes the Continue Scanning dialog box to appear.
- If the scanning side is set to [Auto] and the feeding option is set to [Automatic Feeding], scanning is performed as follows.
 - Documents are automatically detected and scanned when placed in the feeder.
 - The Start key lamp lights, and the flatbed enters a standby state. If you place a document on the flatbed and press the Start key, the document on the flatbed will be scanned.

- When the [Continue Scanning] dialog box appears, verify that a document is loaded, and click either [Continue Scanning] or [Stop Scanning].

 **Hint**

If Use Continue Scanning dialog in the [Scan] menu is not checked, scanning finishes without displaying the Continue Scanning dialog box.

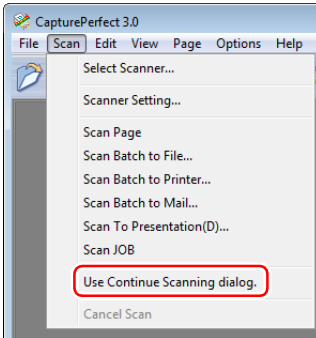

- When scanning is complete, select [Exit] from the [File] menu to quit CapturePerfect 3.0.

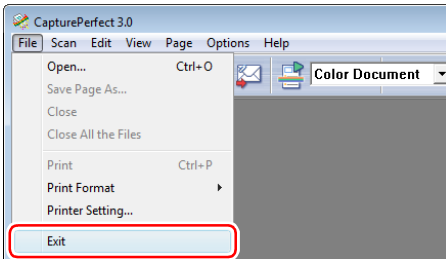

5. Using Patchcode Sheets

A patchcode sheet is a sheet on which a special pattern is printed that allows file separation without interrupting scan processes. Patchcode sheets can be used with applications that support patchcode file separation. When the patchcode sheet is scanned and the pattern is recognized, the document pages that follow can be saved as a separate file.

About Patchcode Sheets

Patchcode sheets are registered in the following location when the ISIS/TWAIN driver is installed.
To use the patchcode sheets, print them out using a printer.

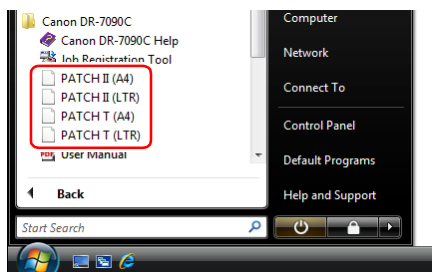

! IMPORTANT

- Patchcode sheets can be used only when the application you are using supports separating files by patchcode patterns.
- Patchcode sheets are data in PDF format. There are four types; [PATCH II (A4)], [PATCH II (LTR)], [PATCH T (A4)], [PATCH T (LTR)], organized according to the paper size and pattern.
- Patchcode sheets cannot be used when the MultiStream function (See “MultiStream Function” on p. 1-10.) is being used by CapturePerfect 3.0.

■ Printing Patchcode Sheets

Open the desired patchcode sheet file with an application that supports CapturePerfect 3.0 or the PDF file format, and print the page image only at its original size.

! IMPORTANT

- Print (at original size) PATCH T (A4) and PATCH II (A4) sheets on A4-size paper, or PATCH T (LTR) and PATCH II (LTR) on LTR paper.

- Patchcode sheets must be printed in their original size. The scanner may not recognize them as patchcode sheets if they are enlarged or reduced.

■ Patchcode Pattern Function

There are two types of patchcodes, and their function changes according to their pattern.

PATCH T



When the scanner recognizes this patchcode printed on a patchcode sheet, it creates a separate file for the document that comes after the patchcode sheet. The image of this sheet can be saved or not, depending on the application's settings.

PATCH II



When the scanner recognizes this patchcode printed on a patchcode sheet, it creates a separate file starting from the patchcode sheet. The image of this sheet is saved, regardless of the application's settings.

How to Use Patchcode Sheets

This section describes how to use patchcode sheets with CapturePerfect 3.0.

1. Print the patchcode sheets on a printer.

! IMPORTANT

- Print (at original size) PATCH T (A4) and PATCH II (A4) sheets on A4 paper, or PATCH T (LTR) and PATCH II (LTR) on LTR paper.
- The scanner may not recognize the patchcodes if they are enlarged or reduced.

2. Insert the patchcode sheet in front of the document that you want to save as a separate file before placing the documents on the scanner.

Insert patchcode sheets in front of the documents you want to save as separate files.

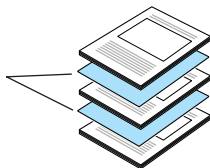

3. On the [Other Settings] dialog box of the ISIS driver properties, select [Patchcode] from the Batch Separation drop-down list.

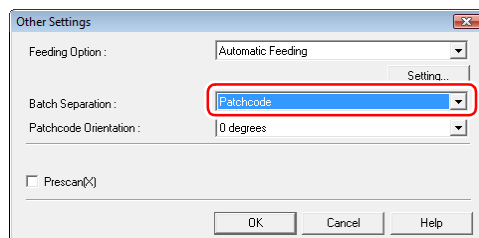

4. Perform scanning with batch separation enabled.

5. Set the [Type of batch separation] setting to [Scan, Continue Scanning] or [Skip, Continue Scanning].

💡 Hint

- If [Scan, Continue Scanning] is selected or if the patchcode is PATCH II type, the patchcode sheet image is also saved and scanning continues.
- If [Skip, Continue Scanning] is selected and the PATCH T pattern is detected, the patchcode sheet image is not saved and scanning continues.

■ Creating a Patchcode Sheet

To copy a patchcode pattern to create a different size patchcode sheet, make sure to pay attention to the following precautions:

! IMPORTANT

- Adjust the patchcode so that it fits into the effective area for detecting patchcode patterns.

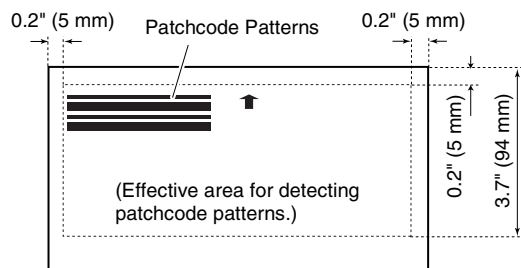

- When copying a patchcode pattern, the copy should be the same size as the pattern on the original.
- Be careful to keep patchcode sheets clean. If a patchcode sheet has been folded or becomes creased, reprint or replace the sheet.

6. Count Only Mode

In Count Only Mode, document pages are sent through the feeder in order to count them. The documents are not scanned in this mode. Operations for Count Only Mode can be performed without a computer.

1. Press the Menu key and display “Count Only Mode” on the display panel.

```
C o u n t   O n l y   M o d e
      O N       [ O F F ]
```

2. Use the ◀ key to select [ON].
3. Press the Enter key to accept the setting.
The Start key lamp lights green.
4. Press the Stop key and display “Count Only Mode” on the display panel.

```
C o u n t   O n l y   M o d e
                        0 0 0 0 0
```

5. Place the document in the feeder, and press the Start key.

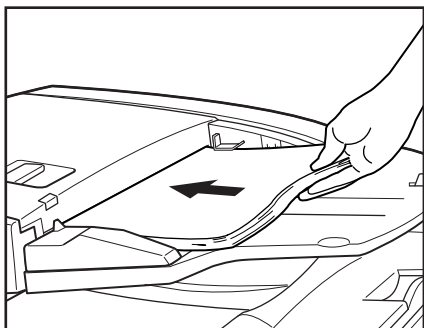

The document is sent through the feeder, and the number of pages appears on the counter display area.

6. Press the Stop key to exit Count Only Mode.
To clear the page count in the counter display area, press and hold the Stop key for approximately 2 seconds.

7. Clearing Paper Jams

A paper jam is indicated when scanning stops unexpectedly and the message shown below appears on the display panel. Use the procedure below to clear a paper jam.



Hint

- The document set indicator on the feeder cover flashes when a paper jam occurs.
- The error code, “xxx”, will vary depending on the detected location of the paper jam.

Clearing a Paper Jam

WARNING

- Be careful when you clear a paper jam. You may be injured unexpectedly. For example, the paper edges may cut your fingers, or the document may be damaged.
- Remove all jammed sheets of paper. Paper scraps left inside the scanner may be drawn into the scanner again, causing another paper jam or malfunction.
- When opening or closing the feeder, take care not to get your fingers caught.

1. Remove all document pages from the document feeder tray and the document eject tray.
2. Open the feeder cover.
Operate the opening lever, and then slowly raise the cover until it stops.

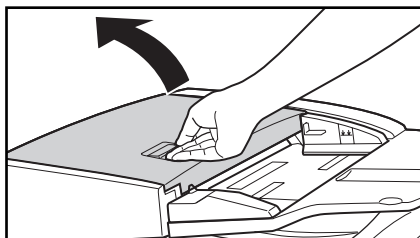

3. Confirm the location of the paper jam.

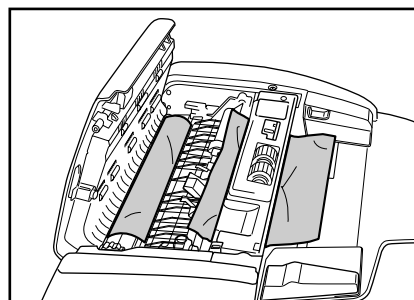

4. If the document is jammed under the feeder guide, grasp the tab inside the scanner to open the feeder guide.

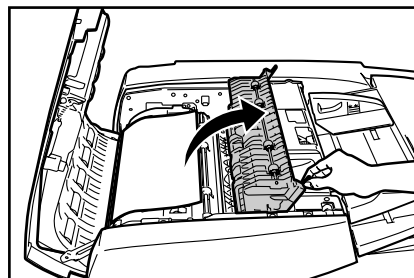

5. Rotate the dial on your side of the scanner to remove any paper jammed inside the feeder.

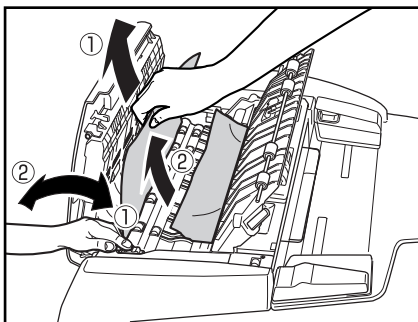

 **Hint**

- Rotating the dial to the right ① reverse feeds any paper jammed inside the feeder. Gently pull the paper from the feeder as you rotate the dial.
- Rotating the dial to the left ② forward feeds jammed paper into the document eject tray. After feeding the paper, raise the document feeder tray and remove the paper.

6. Close the feeder guide.

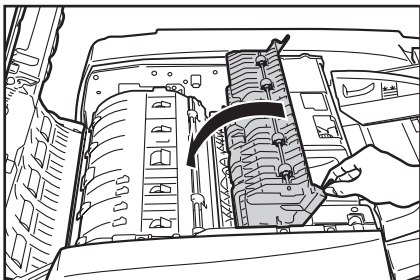

 **CAUTION**

Take care to avoid pinching your fingers when closing the feeder guide.

7. Close the feeder cover.

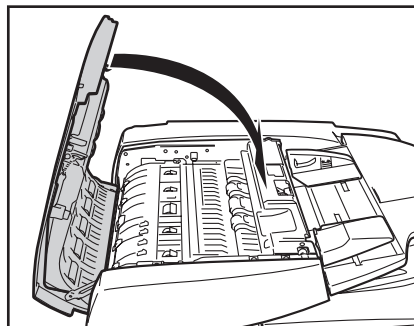

 **CAUTION**

Take care to avoid pinching your fingers when closing the feeder cover.

8. Open the feeder.

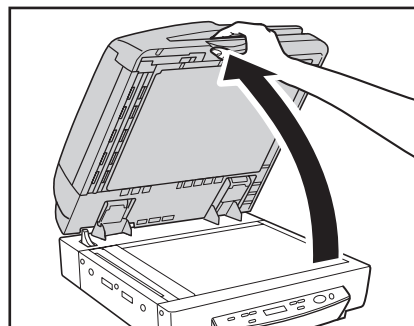

 **CAUTION**

Open the feeder carefully and slowly, taking care to avoid letting the feeder fall over backwards.

9. Remove any paper jammed inside the feeder.

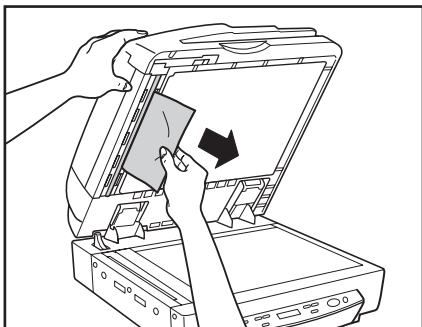

10. Slowly and carefully close the feeder.

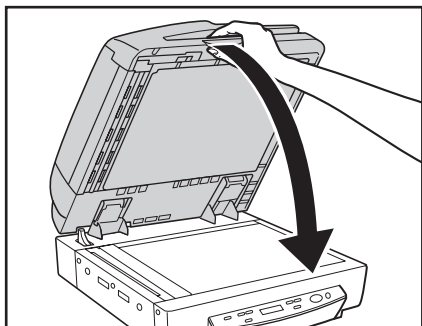

⚠ CAUTION

Lower the feeder slowly, taking care to avoid pinching your fingers. Failure to do so might result in personal injury.

Paper Jam Causes

Any of the following factors can cause paper to jam. If you experience paper jams, check the following points and take the required action:

- **What to check:** Is the document size or thickness outside the range supported by the feeder, or is the document paper of substandard quality?
What to do: See “Documents” on p. 3-2 for information about required document properties.
- **What to check:** Is a jam being caused by document paper that is not sliding properly?
What to do: Scan such paper from the flatbed (platen glass), one page at a time. (See p. 3-5.)
- **What to check:** Are the rollers inside the feeder dirty or worn?
What to do: If the rollers are dirty, clean them. (See p. 5-6.)
 If the rollers are worn, contact your service representative to have them replaced.

Chapter 4 User Modes

1. About the User Modes	4-2
User Mode Functions	4-2
How to Set the User Modes	4-3

1. About the User Modes

You can configure the scanner settings with the user modes described below.

User Mode Functions

User mode functions are as follows:

■ Count Only Mode

```

C o u n t   O n l y   M o d e
O N       [ O F F ]

```

ON: Counts the number of pages in a document using stand-alone scanner operations. (See “Count Only Mode” on p. 3-21.)

OFF: Normal Mode (default)

■ Long Document Mode

```

L o n g   D o c u m e n t
O N       [ O F F ]

```

ON: Enables detection of documents up to 24.8" (630 mm) long for auto document size detection. (See “Documents” on p. 3-2.)

OFF: Enables detection of documents up to 17.0" (432 mm) long for auto document size detection (default).

! IMPORTANT

- Processing speed may slow down when scanning while the Long Document mode is set.
- When scanning two-sided documents with the Long Document mode set to ON, the documents will be scanned one side at a time, regardless of the single-pass duplex setting.
- When using the Long Document mode, if you place a long document askew in the document tray, it will rub against both sides of the feeding path and may damage the document. Make sure to align the document straight when placing it in the document tray.

- When using the Long Document mode, jam detection may not work properly and document may be damaged. Be wary of paper jams when using Long Document mode.
- When scanning a document that is 17" (432 mm) or more in length, load the document one page at a time and scan.

■ Stand-by Mode

```

S t a n d - b y   M o d e
2 4 0           6 0   [ 1 0 ]

```

240: Scanner enters Stand-by Mode after 4 hours of non-use.

60: Scanner enters Stand-by Mode after an hour of non-use.

10: Scanner enters Stand-by Mode after 10 minutes of non-use (default).

■ Display Language Mode

```

J a p a n e s e   ( ニ ホ ン コ ー )
O N       [ O F F ]

```

ON: Japanese

OFF: English (default)

■ Display Contrast Setting

```

D i s p l a y   C o n t r a s t
< - - - - ■ - - - >

```

Use the ◀ and ▶ keys to move the pointer (■) to the left for lighter contrast or to the right for darker contrast.

■ Setting SCSI Transfer Speed

```

S C S I   S p e e d
[ 2 0 ]   1 0       5
  
```

Set the maximum value for synchronous transfer speed for the SCSI interface.

20: 20 Mbyte/sec (Ultra SCSI) (default)

10: 10 Mbyte/sec (First SCSI)

5: 5 Mbyte/sec (non-synchronous)

If the scanner does not operate correctly when the output speed is set to '20' Mbyte/sec, reduce the transfer speed to '10' Mbyte/sec or '5' Mbyte/sec.

■ Setting USB Short Packet

```

U S B   S h o r t   P a c k e t
[ O N ]   O F F
  
```

Change the USB short packet settings. (default: ON)

If the scanner does not operate normally with your computer's standard USB interface, change the short packet setting to 'OFF'.

! IMPORTANT

If you change the setting for the SCSI transfer speed or the USB short packet settings, turn OFF the scanner, and then turn it ON.

■ Setting Single-Pass Duplex

```

S i n g l e - P a s s   D u p .
[ O N ]   O F F
  
```

Select the duplex (two side) scanning method used for documents placed in the feeder tray.

ON: Scans both sides of the document page simultaneously (default).

OFF: The scanner scans the front side of the document page and then automatically flips the page to scan the reverse side.

■ Total Counter

```

T o t a l   C o u n t e r
                                                0
  
```

Displays the cumulative total number of document pages fed by the scanner.

How to Set the User Modes

Use the following procedure to configure user mode settings.

1. Press Menu to display the user mode screens.

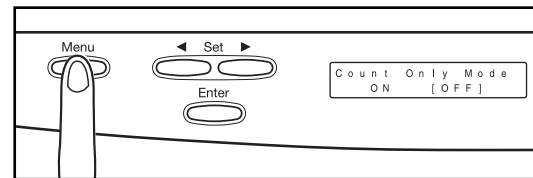

Use the Menu key to cycle through the user modes in the sequence shown below.

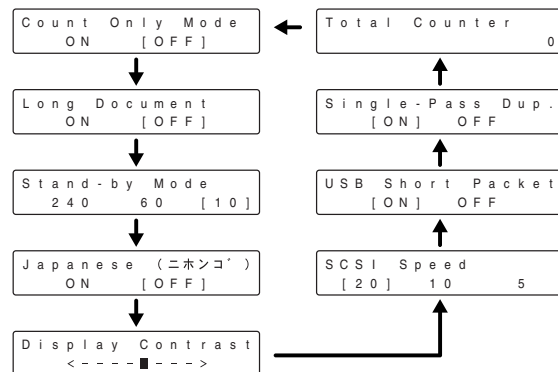

2. Use the ◀ and ▶ keys to change the currently displayed setting.

3. Press Enter to register the displayed setting.

4. To exit the user mode screens, press Stop.

Chapter 5 Maintenance

1. Changing the Stamp Cartridge	5-2
2. Daily Cleaning.....	5-4
About the Cleaning Cloth and Cleaning Paper	5-4
Cleaning the Main Unit.....	5-4
Cleaning the Flatbed (Platen Glass) and Pressure Board	5-5
Cleaning the Feeder.....	5-6
Cleaning the Power Plug.....	5-12

1. Changing the Stamp Cartridge

When using the optional stamp unit (see p. 1-14) to stamp scanned documents, you should use the following procedure to replace the stamp cartridge whenever the stamp mark becomes smudged or faint. Contact your sales representative or service representative to purchase a new stamp cartridge.

1. Open the feeder cover.

Operate the opening lever, and then slowly raise the cover until it stops.

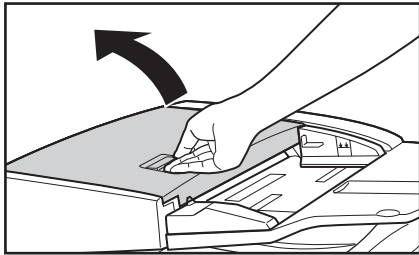

2. Open the feeder guide, and then open the inner cover.

The feeder guide has a green tab, while the inner cover located under the feeder guide has a light blue tab.

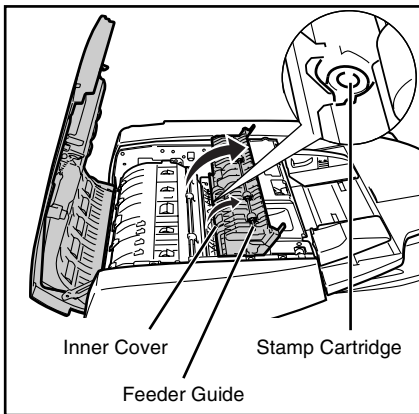

3. Use a pair of tweezers or some similar tool to remove the old stamp cartridge.

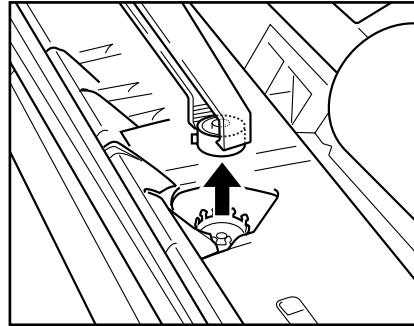

4. Insert a new stamp cartridge.

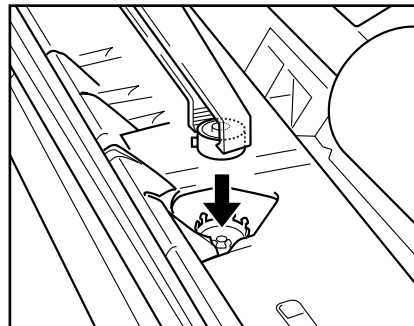

! IMPORTANT

- When installing the stamp cartridge, make sure that the stamp does not protrude outside the hole.
- Improperly installing the stamp cartridge can cause paper jams.

5. Close the feeder guide and inner cover.

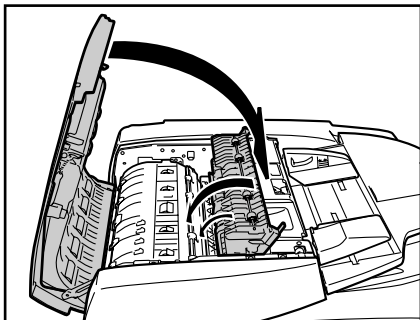

⚠ CAUTION

Take care to avoid pinching your fingers when closing the feeder guide and inner cover.

6. Close the feeder cover.

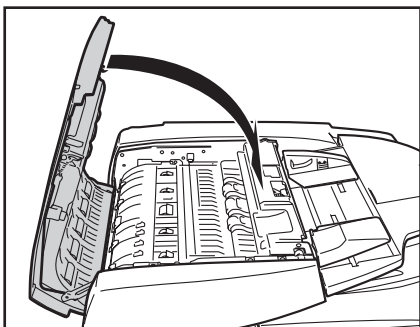

⚠ CAUTION

Take care to avoid pinching your fingers when closing the feeder cover.

2. Daily Cleaning

To maintain high-quality scanning, you should periodically clean the following:

- Main unit
- Flatbed (Platen glass)
- Pressure Board
- Feeder

CAUTION

- Before you clean the scanner, turn OFF the scanner and computer and disconnect the power cord from the power outlet. Otherwise, an electrical shock may result.
- Never clean the scanner with any kind of organic solvent, such as alcohol, benzene, or paint thinner. It might cause a fire and electrical shock, or cause the exterior of the scanner to disfigure or discolor.
- Never spray detergent or water directly onto the flatbed (platen glass). Sprayed liquid can get inside the scanner and soil the light source and lens.
- Overuse of water and allowing the scanner to become too wet during cleaning can damage scanned documents and cause malfunction of the scanner.

About the Cleaning Cloth and Cleaning Paper

Use cleaning cloth and cleaning paper supplied with the scanner as follows.

- Cleaning cloth:
Use the cleaning cloth to clean the scanning glass and rollers.
- Cleaning paper:
Attach the cleaning paper to the scanning area cleaning tool located behind the pressure board. (See p. 5-9 and p. 5-11.)

Cleaning the Main Unit

Wipe the scanner with a firmly wrung cloth moistened slightly with water or mild detergent. Then wipe off with a clean, dry cloth.

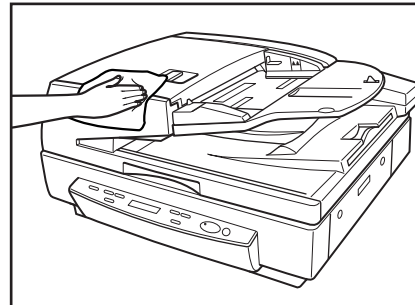

Cleaning the Flatbed (Platen Glass) and Pressure Board

A dirty flatbed (platen glass) or pressure board can cause soiling of scanned images, or document size detection errors. Clean the flatbed (platen glass) and pressure board periodically.

1. Open the feeder.

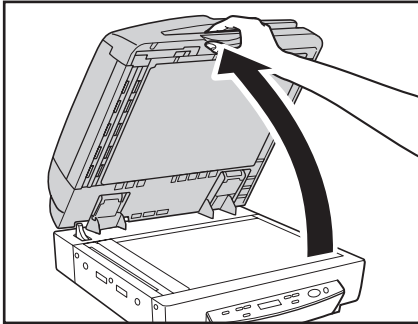

 **CAUTION**

Open the feeder carefully and slowly, taking care to avoid letting the feeder fall over backwards.

2. Wipe the flatbed (platen glass), scanning glass (narrow strip of glass) and pressure board with a cloth moistened with plain water and thoroughly wrung out. Next, wipe the flatbed (platen glass), scanning glass and pressure board with a soft, dry cloth.

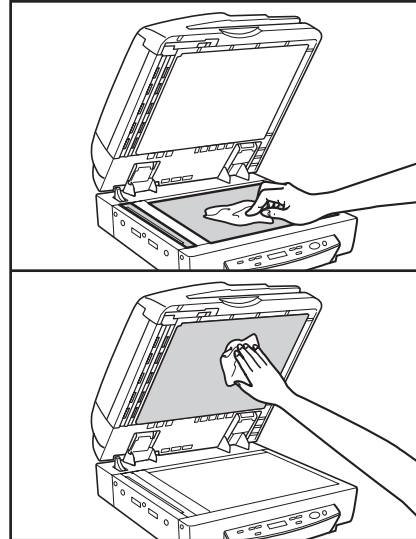

3. Slowly and carefully close the feeder.

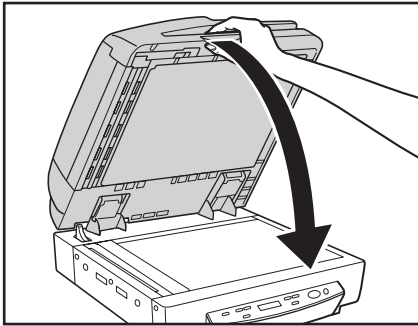

⚠ CAUTION

Lower the feeder slowly, taking care to avoid pinching your fingers. Failure to do so might result in personal injury.

Cleaning the Feeder

Without periodic cleaning, a problem may be caused on the scanned image or the document may become soiled. Clean the feeder periodically.

1. Open the feeder cover.

Operate the opening lever, and then slowly raise the cover until it stops.

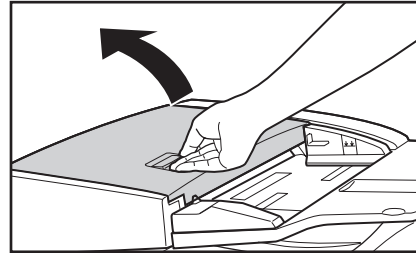

2. Wipe the 13 rollers inside the feeder cover with a cloth moistened with plain water and thoroughly wrung out. Next, wipe the rollers dry with a soft, dry cloth.

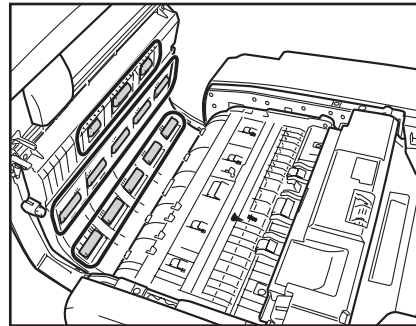

- 3.** Wipe the 13 rollers on the feeder guide with a cloth moistened with plain water and thoroughly wrung out. Next, wipe the rollers dry with a soft, dry cloth.

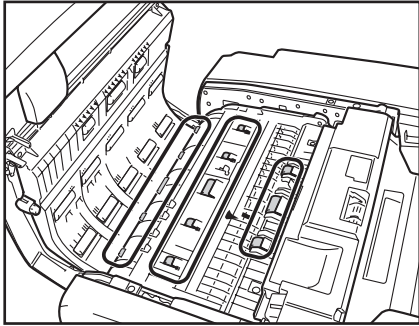

- 4.** Grasp the tab in the front to open the feeder guide.

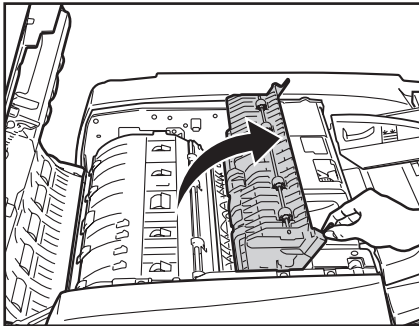

- 5.** Wipe the four rollers with a cloth moistened with plain water and thoroughly wrung out. Next, wipe the rollers dry with a soft, dry cloth.

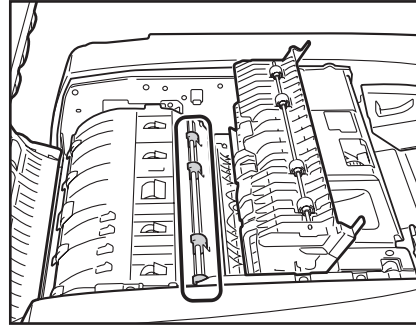

- 6.** Wipe the four rollers inside the feeder guide with a cloth moistened with plain water and thoroughly wrung out. Next, wipe the rollers dry with a soft, dry cloth.

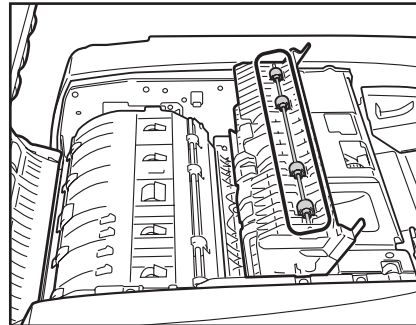

7. Close the feeder guide.

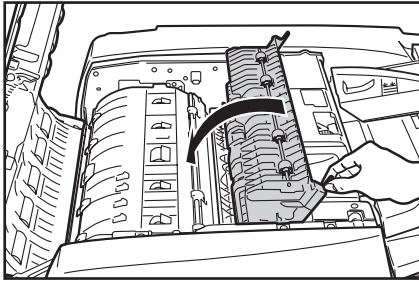

⚠ CAUTION

Take care to avoid pinching your fingers when closing the feeder guide.

8. Close the feeder cover.

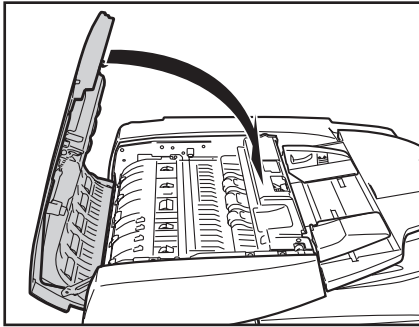

⚠ CAUTION

Take care to avoid pinching your fingers when closing the feeder cover.

9. Open the feeder.

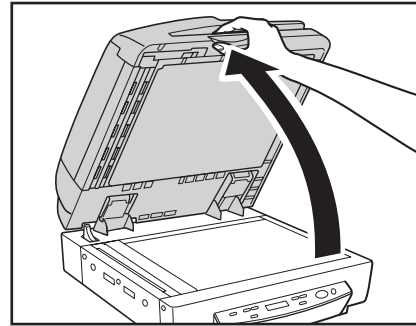

10. Wipe the feeder roller (white) and platen roller (black) with a cloth moistened with plain water and thoroughly wrung out. Next, wipe the metal dry with a soft, dry cloth.

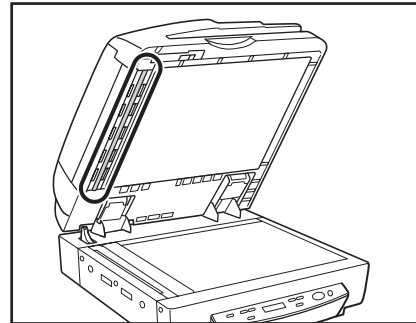

! IMPORTANT

When you open the feeder cover and turn the dial located in the front, the platen roller rotates.

When cleaning the platen roller, rotate the roller slowly while wiping it.

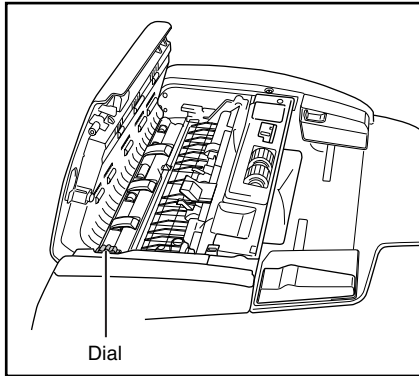

- 11.** Pull the lever on the upper part of the feeder to open the scanning area on the feeder.

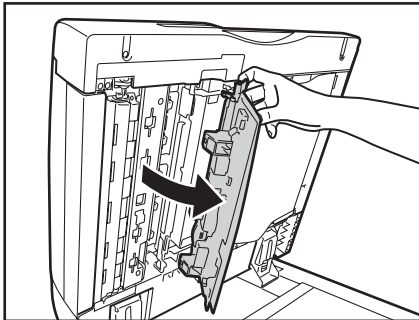

- 12.** Remove the scanning area cleaning tool from inside the cover.

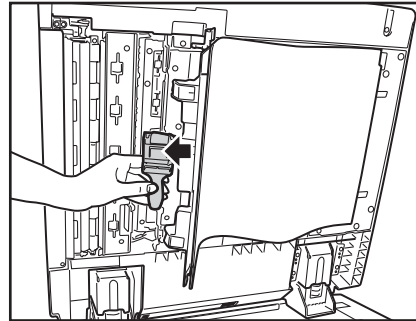

- 13.** Remove one sheet of cleaning paper from the plastic bag, and fold it in two as shown.

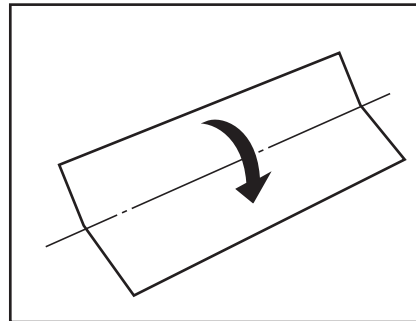

14. Attach the cleaning paper to the scanning area cleaning tool.

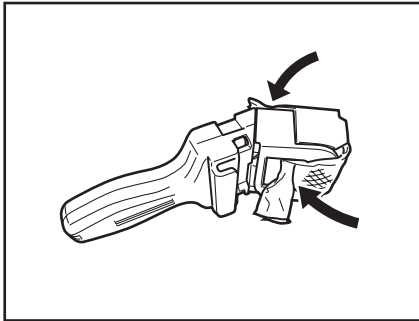

15. Open the inner cover.

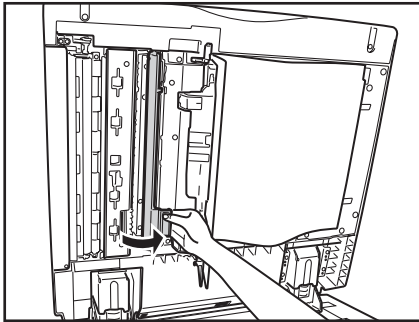

16. Wipe the platen roller located behind the inner cover with a cloth moistened with plain water and thoroughly wrung out. Next, wipe the roller with a soft, dry cloth.

! IMPORTANT

When cleaning the platen roller, rotate the roller slowly while wiping it.

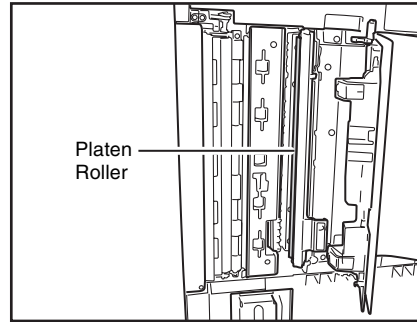

17. Clean the feeder's scanning area along the rail.

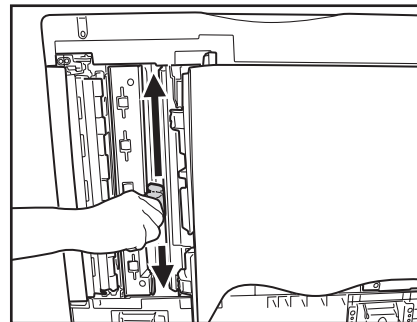

18. Close the inner cover.

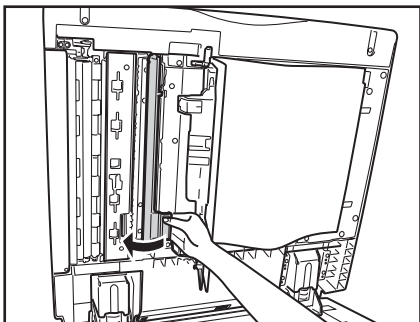

⚠ CAUTION

Take care to avoid pinching your fingers when closing the cover.

19. Remove the cleaning paper from the scanning area cleaning tool, and place the cleaning tool inside the cover.

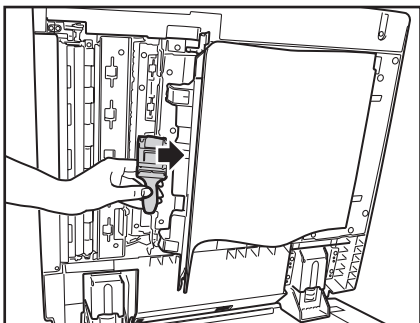

20. Close the cover for the feeder's scanning area.

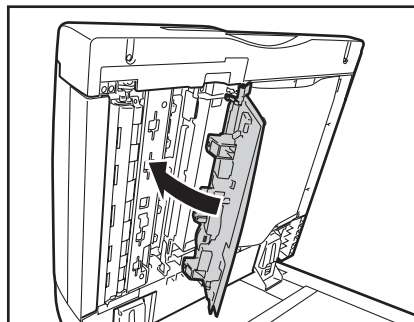

⚠ CAUTION

Take care to avoid pinching your fingers when closing the cover.

21. Press the center part of the cover until it clicks into place. Make sure that the cover is completely closed.

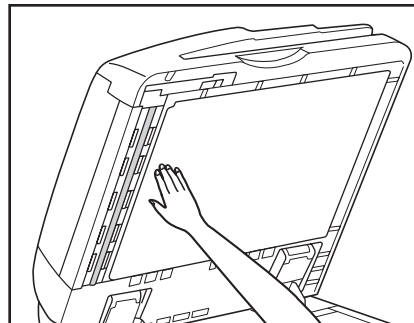

22. Slowly and carefully lower the feeder back down.

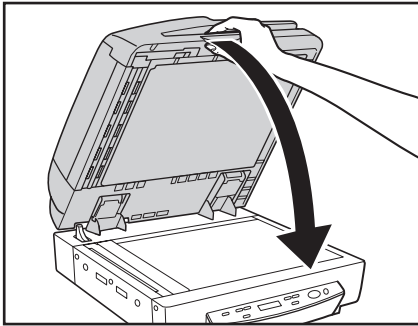

⚠ CAUTION

Lower the feeder slowly, taking care to avoid pinching your fingers. Failure to do so might result in personal injury.

Cleaning the Power Plug

If you leave the power plug connected to the power outlet for a long period of time, dust may accumulate at the power outlet, and cause a fire or electrical shock. Clean the power plug periodically.

Chapter 6 Practical Examples

1. Messages	6-2
Status Display	6-2
Error Messages	6-3
2. Troubleshooting	6-5
Trouble Categories	6-5
Problem and Solution	6-5
3. Uninstalling the Software	6-11
Uninstalling the ISIS/TWAIN Driver	6-11

1. Messages

There are two types of display panel messages: “status indicator messages” and “error messages” that appear when the scanner encounters a problem.

Status Display

The following messages appear on the display panel to indicate the scanner’s operating state:

■ Count Only Mode

```
C o u n t   O n l y   M o d e
                0 0 0 0 0
```

Status: Operating in Count-Only mode.

■ Ready

```
R e a d y
                0 0 0 0 0
```

Status: The scanner is ready to use. If you do not perform any operations for 10 minutes, the scanner will enter Sleep mode.

■ Scanning...

```
S c a n n i n g . . .
                x x x x x
```

Status: Scanning is in progress.

■ Sleeping...

```
S l e e p i n g . . .
```

Status: The scanner is entering the Sleep mode. Press any key to recover.

■ Wait...

```
W a i t . . . .
```

Status: The scanner is busy processing. Wait until the display changes.

■ 01:XXXXXXXX

```
0 1 : X X X X X X X X
```

Status: The scanner is in Job Mode. Press the Start key to scan, or press the Stop key to exit Job Mode. (See “About the Job Function” on p. 3-11.)

Error Messages

When one of the following messages appears on the display panel, an error has occurred in the scanner. Follow the indicated procedure to resolve the error.

■ Cover Open

```
C o v e r   O p e n
                                     C x x x
```

Error Code: C001

Cause: The feeder is open.

Solution: Close the feeder.

Error Code: C002

Cause: The feeder cover is open.

Solution: Close the feeder cover.

■ Jam

```
J a m
                                     P x x x
```

Error Code: Pxxx

Cause: Paper has jammed.

Solution: Remove the jammed paper. (See p. 3-22.)

■ Misfeed

```
M i s f e e d
                                     A x x x
```

Cause: Feed error

Solution: Check the document and try again. If this error continues to appear, scan the document from the flatbed (platen glass).

■ Send failed

```
S e n d   f a i l e d .
```

Cause: An error occurred while transferring image data for a Job function.

Solution: Check the Job Registration Tool settings, and scan again. For details, see [Chapter 9 “Job Registration Tool Settings”](#) of the Software section.

■ Detect Mix Doc.

```
D e t e c t   M i x   D o c .
                                     J x x x
```

Cause: Mixed size documents were detected while scanning at 600 dpi resolution.

Solution: Check the size of the documents, and scan again. If this message appears when you are scanning documents of different sizes, set the mixed document mode to ON in the scanner settings to prevent this message from appearing.

■ Call for Service

```
C a l l   f o r   S e r v i c e
                                     E x x x x x x x
```

Error Code: E2020001

Cause: The transportation screws are still installed on the scanner.

Solution: Turn the scanner OFF, and remove the transportation screws. (See p. 1-2.)

Error Code: E2250101

Cause: The amount of light emitted from the reverse-side scanning sensor is insufficient.

Solution: If you restart the scanner, the “Single-Pass OFF” message appears. (See [“Single-Pass OFF” on p. 6-4.](#))

Error Code: E4000100

Cause: One or more of the rear cables are disconnected.

Solution: Turn the power OFF, and check the rear of the scanner, and reconnect any cables that are disconnected.

(See “Checking the Rear Cables” on p. 1-4.)

Error Code: Exxxxxxx (any error code not listed above)

Cause: Internal scanner error.

Solution: Turn the power OFF, and restart the scanner. If this does not solve the problem, make a note of the error code and contact your Canon service representative.

■ Single-Pass OFF

S i n g l e - P a s s O F F

Cause: This appears when the scanner is restarted after the “Call for Service E2250101” (insufficient light from the reverse-side scanning sensor) error message appears.

Solution: The amount of light emitted is insufficient for scanning the reverse side of the document, and single-pass duplex scanning is disabled. Press any key on the operation panel to clear the message and enable normal scanning. Contact your local dealer or Canon service representative, and replace the reverse-side scanning sensor.

2. Troubleshooting

This section describes the problems that may occur during use of the scanner and how to solve them.

Trouble Categories

The following trouble categories are addressed:

- [The Scanner Does Not Turn ON \(See p. 6-5\)](#)
- [The “Wait” Message Does Not Disappear \(See p. 6-5\)](#)
- [The Scanner Is Not Recognized \(Connecting via USB\) \(See p. 6-6\)](#)
- [The Scanner Is Not Recognized \(Connecting via SCSI\) \(See p. 6-6\)](#)
- [Scanning Is Not Performed \(See p. 6-7\)](#)
- [Slow Scanning Speed \(See p. 6-7\)](#)
- [Documents Do Not Feed Properly \(See p. 6-8\)](#)
- [Saved Image Files Do Not Open \(See p. 6-8\)](#)
- [Scanning Results Are Not as Expected \(See p. 6-8\)](#)
- [The Display Panel Does Not Display Properly \(See p. 6-10\)](#)
- [Job Functions Do Not Operate Properly \(See p. 6-10\)](#)

If you cannot resolve a problem, contact your local authorized Canon dealer or your service representative.

Problem and Solution

■ The Scanner Does Not Turn ON

If the scanner does not turn ON, first confirm the following:

- ✓ Is the power cord connected correctly?
- ✓ Is the power cord inserted into the power outlet?

■ The “Wait” Message Does Not Disappear

Make sure that the cables at the rear of the scanner are properly connected, and then restart the scanner.

If the message does not disappear after restarting the scanner, contact your local Canon dealer or service representative.

W a i t

■ The Scanner Is Not Recognized (Connecting via USB)

If the scanner's USB connection is not recognized, first confirm the following:

- ✓ Are the scanner and PC connected correctly using the proper cable?
- ✓ Is the scanner's power switch turned ON?

If this does not solve the problem, consider the following possible causes:

Cause	The scanner does not support your USB interface.
Solution	This product is not guaranteed to operate with all types of USB interfaces. Contact your local authorized Canon dealer or service representative for more information.
Cause	The scanner does not support the USB cable.
Solution	Use the USB cable provided with the scanner.
Cause	The USB hub is not compatible with the scanner.
Solution	Remove the USB hub.
Cause	The SCSI terminator is not set to ON.
Solution	When using a USB connection, proper scanning may not be possible if the SCSI terminator is not set to ON. Make sure to set the SCSI terminator to ON. (See "Setting the SCSI ID and terminator" on p. 2-7.)

■ The Scanner Is Not Recognized (Connecting via SCSI)

If the scanner's SCSI connection is not recognized, first confirm the following:

- ✓ Are the scanner and PC connected correctly using the proper cable?
- ✓ Is the scanner's power switch turned ON?
- ✓ Is the SCSI card in the PC operating properly?
- ✓ Was the PC turned ON before the scanner?

IMPORTANT

When using the SCSI connection, if the scanner is turned ON after the PC, it may not be properly recognized by the PC.

If this does not solve the problem, consider the following possible causes:

Cause	The SCSI card is not compatible with the scanner.
Solution	Use a recommended SCSI card. (See p. 2-3.)
Cause	The scanner's SCSI ID is identical to the SCSI ID of another device.
Solution	Check the SCSI IDs of all SCSI devices connected to the system and set a unique SCSI ID for the scanner.
Cause	The terminator is not set correctly.
Solution	When another SCSI device is connected between the scanner and the PC, that device's terminator must be disabled (set to OFF).
Cause	There is a problem with another SCSI device that is connected in the daisy chain.
Solution	Do not use the daisy chain connection configuration.

■ Scanning Is Not Performed

If scanning does not start when it should, first confirm the following:

- ✓ Are the scanner and PC correctly connected with the proper cable?
- ✓ Is the scanner's power switch turned ON?

If this does not solve the problem, consider the following possible causes:

Cause	The ISIS/TWAIN driver and Job Registration Tool are not installed correctly
Solution	Uninstall and then reinstall the ISIS/TWAIN driver and Job Registration Tool.
Cause	Another application is using the driver for this scanner.
Solution	Exit the application that is using the driver.
Cause	Memory is insufficient due to scan conditions that require large amounts of memory.
Solution	Exit the application currently in use, change the scanning configurations after restarting the application, and try scanning again.

! IMPORTANT

If the scanner does not operate because of a system error, turn the scanner OFF and wait at least 10 seconds before turning it back ON. If errors continue to occur, reboot the scanner and computer.

■ Slow Scanning Speed

If the scanning speed is slow, first confirm the following: Scanning may be slow if the USB interface does not support Hi-Speed USB 2.0.

- ✓ Does the PC's USB interface support only Full-Speed USB 1.1?
- ✓ Is the USB cable you are using the one that was supplied with the scanner (Hi-Speed USB 2.0 compliant)?
- ✓ Is a USB 1.1-compliant device connected to the USB hub at the same time?

If this does not solve the problem, consider the following possible causes:

Cause	Other applications are running in the background on your PC.
Solution	Quit all other applications that are running.
Cause	Resident applications, such as anti-virus software, are draining memory resources.
Solution	Quit all resident applications.
Cause	Temporary files cannot be created in the TEMP folder, as there is not enough free space on the hard disk.
Solution	Delete unnecessary files on the hard disk to increase free space.

■ The Two Sides of a Document are Not Scanned Simultaneously During Duplex Scanning

If the two sides of a document are scanned one side at a time during duplex scanning, confirm the following:

- ✓ Is Single-Pass Duplex set to ON in the user mode settings?
- ✓ Is Long Document mode set to OFF? (See p. 4-2.)

! IMPORTANT

Single-pass duplex scanning is disabled when the amount of light emitted from the reverse-side scanning sensor is insufficient. (See p. 6-3.)

■ Documents Do Not Feed Properly

If a document does not feed properly, first confirm the following:

- ✓ Are pages sticking together because of static electricity or another cause?
- ✓ Are you attempting to scan a document with size, paper thickness or quality that is not supported by the scanner? (See “Documents” on p. 3-2.)
- ✓ Are the rollers dirty?
- ✓ Are the rollers worn out?

! IMPORTANT

- Double feeding occurs when document pages stick together, and incompatible paper thickness or quality can cause paper jams. Check your documents carefully before loading.
- Replacement rollers can be purchased as consumables. If performance is not improved after cleaning the rollers, contact your local Canon dealer or service representative.

If this does not solve the problem, consider the following possible problems and causes:

Problem	Cannot scan from the feeder.
Cause	The scanning side setting for the ISIS/TWAIN driver is set to [Flatbed].
Solution	Set the scanning side to a setting other than [Flatbed].

■ Saved Image Files Do Not Open

If image files saved by CapturePerfect 3.0 cannot be opened by another application, first confirm the following:

- ✓ Does the application you are using support CapturePerfect 3.0 image file types (*.bmp, *.tif, *.jpg and *.pdf)?

If this does not solve the problem, consider the following possible causes:

Cause	The application does not support multi-page TIFF files.
Solution	Open the files using an application that supports multi-page TIFF files, or save the images as single-page TIFF files using CapturePerfect 3.0.
Cause	The compression format used by CapturePerfect 3.0 is not supported.
Solution	Open the image file with CapturePerfect 3.0, set the compression format to [None], and save it again.

■ Scanning Results Are Not as Expected

If the scanned images do not appear as expected, one or more ISIS/TWAIN driver settings may be incorrect, or your application may not support certain scanner functions.

Problem	The scanned image is too dark (or faint).
Cause	The [Brightness] setting is not set to an appropriate value.
Solution	If the image is too dark, set a higher brightness setting, or if the image is too faint, set a lower brightness setting.

Problem	Text or images from the back side of your document appear in the scanned image.
Cause	Brightness may be set too low.
Solution	Increase the Brightness setting.
Cause	The paper is too thin.
Solution	Photocopy the document, and scan the copy.

Problem	Double-sided scanning is not possible.
Cause	Scanning Side is set to [Simplex].
Solution	Set Scanning Side to [Duplex]. If the Scanning Side is set to [Skip Blank Page], images of blank pages are not saved.

Problem	A black margin appears around the scanned document.
Cause	A document smaller than the preset paper size has been scanned. Or, the loaded document has shifted out of position.
Solution	Set the page size setting to [Auto Detection].

Problem	The scanned image is skewed.
Cause	The document has been fed at an angle. (skew)
Solution	Slide the document guides to match the width of your document.

Problem	Lines, smudges, or dirt appear on the scanned image.
Cause	The scanning glass or rollers inside the scanner are dirty.
Solution	Clean the scanning glass and roller inside the feeder. (See “Daily Cleaning” on p. 5-4.) If lines still appear on the image even after you clean the scanning glass and rollers, the scanning glass inside the scanner may be scratched. Contact your local authorized Canon dealer or service representative.

Problem	The scanned image is abnormal for certain documents.
Cause	A detection function such as border removal is enabled when scanning a document that includes text or photos extending to the edge of the page (the scanner cannot accurately process the edges of documents).
Solution	When a page has text or photos extending to its edges, turn the detection functions off or scan that page individually.

Problem	The scanned image is abnormal in some applications.
Cause	A function not supported by the application was used.
Solution	Some applications do not support functions such as auto-detection of page size, so scanning with such applications will produce abnormal scanned images. If abnormal image appearance seems to be application-dependent, try scanning with auto-detection disabled.

■ The Display Panel Does Not Display Properly

Consider the following possible problem and causes:

Problem	The panel display is in Japanese.
Cause	The panel display is set to Japanese in the user mode settings.
Solution	Set the panel display to English in the user mode settings. (See “About the User Modes” on p. 4-2.)

Problem	The panel display is dark.
Cause	The brightness setting for the display panel needs adjustment.
Solution	Adjust the Display Contrast in the user mode settings. (See “About the User Modes” on p. 4-2.)

■ Job Functions Do Not Operate Properly

Job data is stored on your computer. If Job functions do not operate properly, first confirm the following:

- ✓ Is your computer turned on?
- ✓ Is your computer properly connected to the scanner?

If this does not solve the problem, consider the following possible problems and causes:

Problem	The job title does not appear after pressing the Job keys.
Cause	The job was not registered using Job Registration Tool.
Solution	Register the job using Job Registration Tool. For details, see Chapter 9 “Job Registration Tool Settings” of the Software section.

Problem	The Job function does not operate after selecting the job and pressing the Start key.
---------	---

Cause	The Windows Events function is not configured properly.
-------	---

Solution	Configure the Windows Events function settings so that [DR-7090C Job Tool] starts up.
----------	---

Problem	Scanning is not performed and the “Send failed” message appears after selecting the job and pressing the Start key.
---------	---

Cause	<ol style="list-style-type: none"> 1) The ISIS/TWAIN driver is being used by another application. 2) The feeder is specified for document feeding, but there are no documents placed on the feeder.
-------	---

Solution	<ol style="list-style-type: none"> 1) Exit the application that is currently using the ISIS/TWAIN driver. 2) Place the document in the feeder, and scan again.
----------	--

3. Uninstalling the Software

Some scanner malfunctions can be resolved by reinstalling the software. Before reinstalling the software, make sure to completely uninstall any previous installation first.

Uninstalling the ISIS/TWAIN Driver

The following procedure uses the ISIS/TWAIN driver as an example. Follow the same procedure to uninstall the Job Registration Tool and CapturePerfect 3.0. Make sure to substitute the name of the software in step 3.

! IMPORTANT

As always when uninstalling software, log on using an account with Administrator privileges.

1. From the Windows task bar, click [Start] → click [Control Panel].
The Control Panel appears.

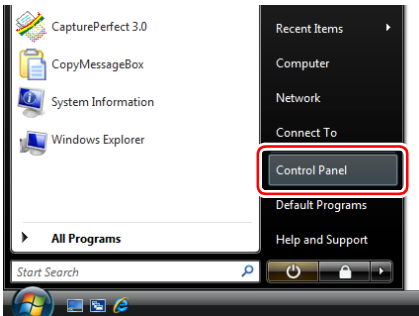

2. Double click [Programs].

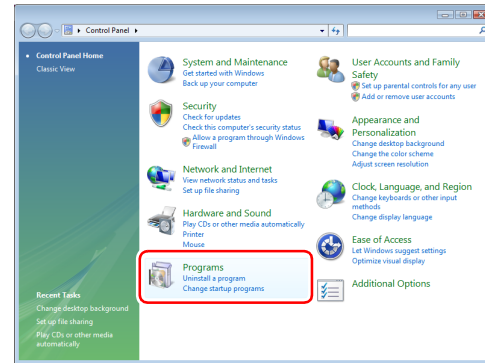

3. From the program list, select the application to be removed and click the [Uninstall] button.

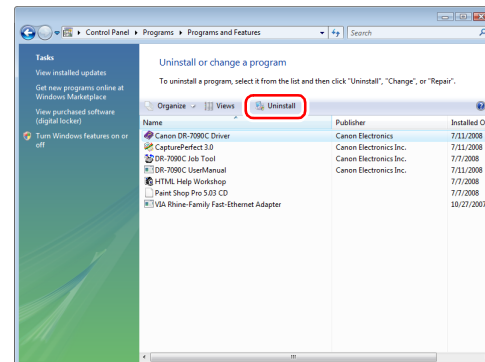

The file-deletion confirmation screen appears.

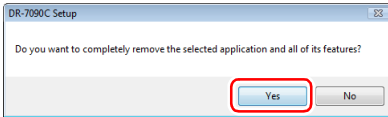

4. Click [Yes] to proceed with uninstallation.
5. When uninstallation is finished, click [Finish].

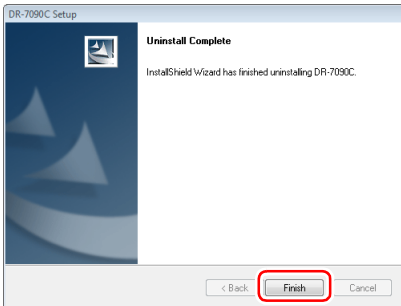

Chapter 7 Appendix

1. Specifications.....	7-2
Specifications for the Scanner	7-2
Options.....	7-3
Consumables	7-3
External Dimensions	7-4
2. Index	7-5

1. Specifications

Specifications for the Scanner

Type

Desktop ADF/flatbed scanner

Document Size

Width: 5.5" to 11.7" (139.7 mm to 298.1 mm)

Length: 5.0" to 17.0" (128 mm to 431.8 mm)

(Normal Mode)

5.0" to 24.8" (128 mm to 630 mm)

(Long Document Mode)

Document Thickness

Black-and-white Documents

- Simplex: 0.002" to 0.006" (0.06 mm to 0.15 mm)

- Duplex: 0.002" to 0.006" (0.07 mm to 0.15 mm)

- Black-and-white/Color Documents Mixed

0.002" to 0.006" (0.07 mm to 0.15 mm)

Color Documents

0.003" to 0.006" (0.08 mm to 0.15 mm)

Documents Longer than 17" (432 mm)

0.003" to 0.006" (0.08 mm to 0.14 mm)

Document Weight

Black-and-white Documents

- Simplex: 11 to 32 lb bond (42 to 128 g/m²)

- Duplex: 13 to 32 lb bond (50 to 128 g/m²)

- Black-and-white/Color Documents Mixed

13 to 32 lb bond (50 to 128 g/m²)

Color Documents

17 to 32 lb bond (64 to 128 g/m²)

Documents Longer than 17" (432 mm)

16 to 24 lb bond (60 to 90 g/m²)

Document Feeding

Feeder/Flatbed

Scanning Method

3-line CCD, CIS

Light Source

Xenon lamp

Scanning Sides

Simplex/Duplex

Scanning Modes

Black and White, Error Diffusion, Advanced Text

Enhancement, Advanced Text Enhancement II, 256-

Level Grayscale, and 24-Bit Color

Scanning Resolution

(primary scan lines x secondary scan lines)

600 x 600 dpi/400 x 400 dpi/300 x 300 dpi/

240 x 240 dpi/200 x 200 dpi/150 x 150 dpi/

100 x 100 dpi

Scanning Speed (A4 landscape)

	Simplex	Duplex	
Black-and-White	200 dpi	70 ppm	
	300 dpi	70 ppm	
	400 dpi	50 ppm	
	600 dpi	50 ppm	
	Gray	200 dpi	70 ppm
		300 dpi	70 ppm
Color	400 dpi	50 ppm	
	600 dpi	50 ppm	
	200 dpi	70 ppm	
	300 dpi	70 ppm	
	400 dpi	50 ppm	
	600 dpi	50 ppm	

Automatic Feed

Max. 100 sheets (20 lb bond or 80g/m²) or stack 0.5" (13 mm) or less

Interface

SCSI-III/Hi-Speed USB 2.0

Other Functions

Automatic paper size detection, Dropout color, Count

Only Mode, Job function

Dimensions

24.3" (W) x 23.7" (D) x 12.5" (H)

(618 mm (W) x 602 mm (D) x 317 mm (H))

Weight

Approximately 90.4 lb (41 kg)

Power Requirement

AC 120 V (60 Hz), 1.8 A (max)

AC 220-240 V (50/60 Hz), 1.2 A (max)

Power Consumption

120 V model Operating: 218 W maximum

Standby: Under 3.5 W

220-240 V model Operating: 210 W maximum

Standby: Under 4.3 W

Noise

Less than 72 dB

Operating Environment

Temperature: 59°F to 86°F (15°C to 30°C)

Humidity: 25% to 80% RH

- You can use the functions noted above if the software supports them.
- They may not work depending on your computer's capabilities and the software you are using.

Specifications are subject to change without notice.

Options

Stamp Unit

Stamps a mark on the surface of a document to indicate it has been scanned. (See “Stamp Unit” on p. 1-14.)

Consumables

Stamp Cartridge

For replenishing the stamp unit.

Cleaning paper

Cleaning paper that is attached to the cleaning tool and used to clean the scanning area inside the feeder.

- For details about options and consumables, contact your sales representative or your service representative.

External Dimensions

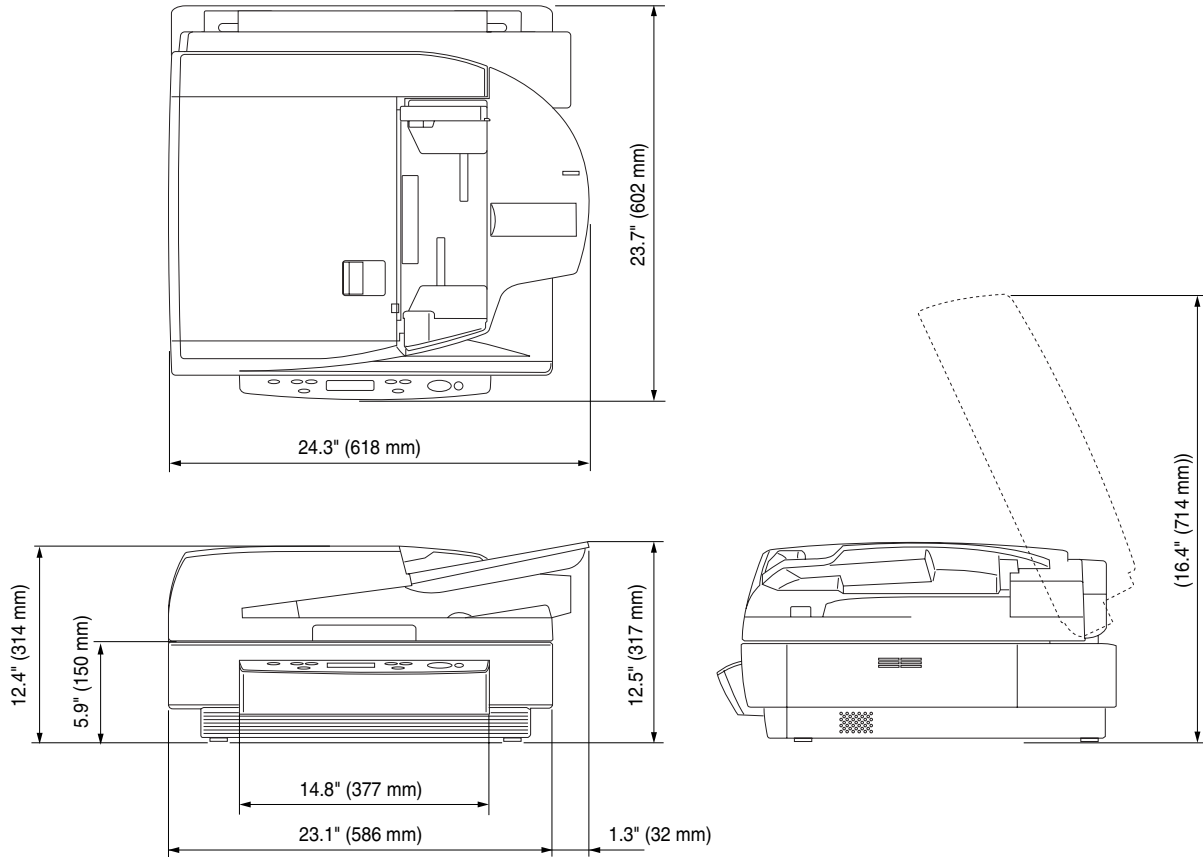

2. Index

A

Automatic Feeding 3-10

C

Cleaning

Feeder 5-6
 Flatbed 5-5
 Main Unit 5-4
 Platen Glass 5-5
 Power Plug 5-12
 Cleaning tool 5-10
 Connecting to a Computer 2-6
 Consumables 7-3
 Count Only Mode 4-2
 Custom Installation 2-5

D

Daily Cleaning 5-4
 Daisy chain 2-8
 DIP Switches 1-12
 Display Contrast 4-2
 Display Panel 1-12
 Document Eject Tray 1-11
 Document Feeder Tray 1-11
 Document Set Indicator 1-11
 Documents 3-2
 Feeder Capacity 3-3
 Loading 3-4
 Types 3-2

E

Enter Key 1-12
 Events Function 3-13
 External Dimensions 7-4

F

Feeder 3-4
 Feeder Cover 1-11

Feeding 3-8
 Automatic Feeding 3-10
 Panel Feeding 3-9
 Standard Feeding 3-8
 Flatbed 3-5
 Flatbed (Platen Glass) 1-11

H

Handling 1-5

I

Installation Location 1-2
 Installation Requirements 2-3

J

Job Function 3-11
 Job Keys 1-13
 Job Mode 3-12
 Job Registration Tool 3-11

M

Manuals for the Scanner iii
 Menu Key 1-12
 Moving the Scanner 1-4

N

Names and Functions of Parts 1-11
 New File Key 1-13

O

Opening Lever 1-11
 Opening Sensor 1-11
 Operation Panel 1-11, 1-12
 Options 7-3

P

Panel Feeding 3-9
 Paper Jam
 Causes 3-24
 Clearing 3-22
 Patchcode
 How to Use 3-20

Patchcode Pattern	3-19
Patchcode Sheets	3-19
Power	1-3
Power Cord Connector	1-12
Power Switch	1-11, 2-9
Practical Examples	6-1
Pressure Board	1-11
R	
Read Manual	2-5
S	
Scanning area cleaning tool	1-11
SCSI Cards	2-3
SCSI Connection	2-7
SCSI Connectors	1-12
SCSI ID	2-7
Securing Braces	1-3, 1-11
Set Keys	1-12
Setup	2-2
Setup Menu	2-4
Single-Pass Duplex	4-3
Slide Guide	1-11
Software Installation	2-4
Specifications	7-2
Stamp Cartridge	5-2
Stamp Unit	1-14
Standard Feeding	3-8
Stand-by Mode	4-2
Start Key	1-13
Stop Key	1-13
T	
Transportation Screw	1-2
Typical Installation	2-4
U	
USB Connection	2-6
USB Connector	1-12
User Mode	
Functions	4-2
How to Set	4-3

User Manual

Software

Please read this manual before using the scanner.
After you finish reading this manual, keep it in a safe place
for future reference.



Table of Contents

Chapter 8 ISIS/TWAIN Driver Settings

- 1. Before Use 8-2
- 2. ISIS/TWAIN Driver Settings Dialog Boxes 8-4
 - Basic Setup Dialog Box 8-5
 - Scan Area Dialog Box 8-9
 - Orientation Settings Dialog Box..... 8-11
 - Advanced Settings Dialog Box 8-12
 - Gamma Settings Dialog Box 8-15
 - Other Settings Dialog Box 8-16

Chapter 9 Job Registration Tool Settings

- 1. Before Use 9-2
 - Job Function 9-2
 - Starting Job Registration Tool 9-2
- 2. Job Registration Tool 9-3
- 3. Settings Dialog Boxes 9-4
 - [New/Editing] Dialog Box 9-4
 - [Admin] Dialog Box 9-9

Chapter 10 Practical Examples

- 1. About Basic Condition Settings 10-2
 - Confirming Basic Conditions for Scanning 10-2
- 2. Practical Examples 10-4
 - Scanning Documents of Unregistered
Page Sizes 10-4
 - Specifying Scanning Area 10-5
 - Configuring Scanner Settings According
to Purpose 10-5
 - Registering Your Settings..... 10-8

Chapter 8 ISIS/TWAIN Driver Settings

1. Before Use	8-2
2. ISIS/TWAIN Driver Settings Dialog Boxes.....	8-4
Basic Setup Dialog Box.....	8-5
Scan Area Dialog Box	8-9
Orientation Settings Dialog Box	8-11
Advanced Settings Dialog Box.....	8-12
Gamma Settings Dialog Box	8-15
Other Settings Dialog Box.....	8-16

1. Before Use

An application program that supports the ISIS or TWAIN driver is required to use the DR-7090C. The DR-7090C requires that it be selected for use as a scanner. The supplied CapturePerfect 3.0 application uses the ISIS driver. This section describes how to select the scanner using CapturePerfect 3.0 (an ISIS-compatible application program).

As the scanner selection procedure depends on the application program being used, refer to your application's user's manual as needed to select the scanner.

! IMPORTANT

- When the conditions for scanning require a large amount of the computer's memory, scanning may not be possible if the memory is insufficient. If a memory error appears during scanning, exit the application and change the scanning conditions before attempting to scan again.
- Configurations that use the computer's memory include the following. If memory becomes insufficient, consider changing these configurations.

[Mode \(24-bit Color\)](#), [Dots per inch \(600 dpi\)](#), [Page Size \(Auto-detection\)](#), [Deskew](#)

💡 Hint

The Job Registration Tool is a TWAIN-compliant application dedicated to the DR-7090C, and requires no scanner selection.

1. From the Windows task bar, click [Start] → click [All Programs] → [CapturePerfect 3.0] → [CapturePerfect 3.0].

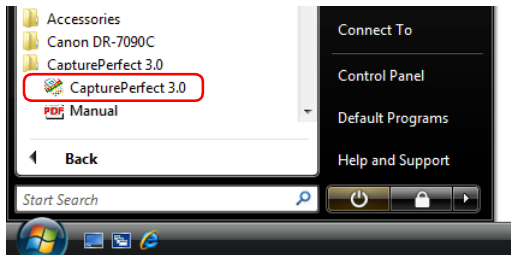

CapturePerfect 3.0 starts.

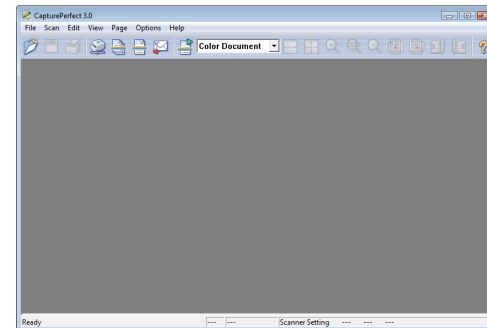

2. Click [Select Scanner] in the [Scan] menu.

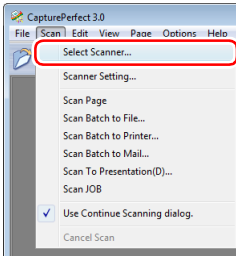

The [Select Scanner] dialog box appears.

3. Select [Canon DR-7090C] → click the [Settings] button.

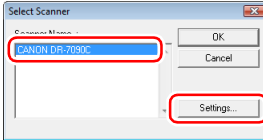

If [Canon DR-7090C] does not appear, try installing the ISIS/TWAIN driver again.

4. Set a default page size.

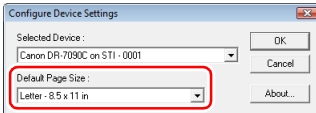

! IMPORTANT

- The default page size becomes the ISIS driver default setting. (See p. 8-7.)
- With the TWAIN driver, the default paper size is A4 and cannot be changed.

5. Click [OK] to finish scanner selection.

6. Click [Scanner Setting] in the [Scan] menu.

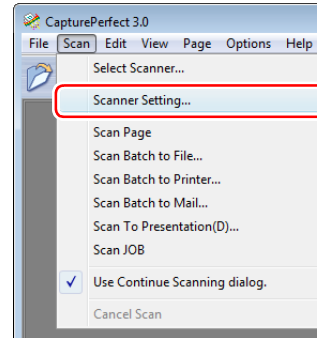

The settings dialog box for the ISIS driver appears.

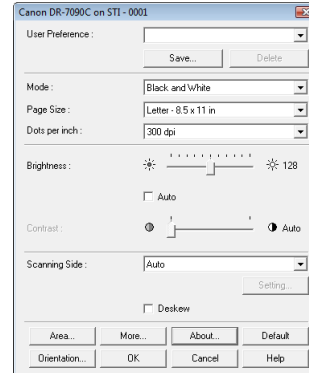

For details on the settings dialog box for the ISIS driver, see [“ISIS/TWAIN Driver Settings Dialog Boxes” on p. 8-4.](#)

2. ISIS/TWAIN Driver Settings Dialog Boxes

This settings dialog boxes for the ISIS/TWAIN driver consist of the Basic Setup dialog box, Advanced Settings dialog box, and Other Settings dialog box. The contents of the settings dialog boxes depend on whether the ISIS or TWAIN driver is used. For details, see the description of each dialog box.

Basic Setup Dialog Box (See p. 8-5)

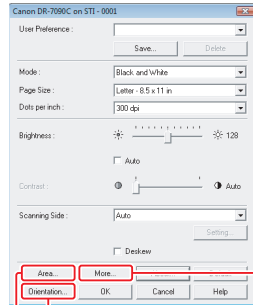

Orientation Settings Dialog Box (See p. 8-11)

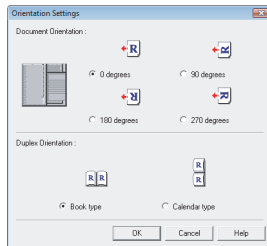

Scan Area Dialog Box (See p. 8-9)

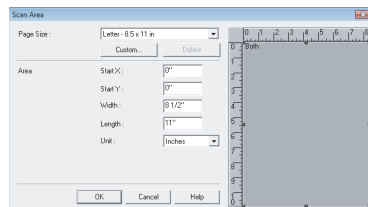

Advanced Settings Dialog Box (See p. 8-12)

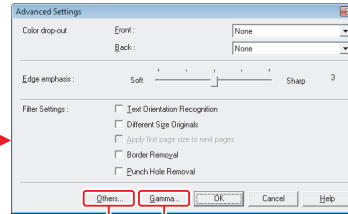

Gamma Settings Dialog Box (See p. 8-15)

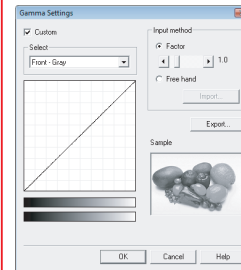

Other Settings Dialog Box (See p. 8-16)

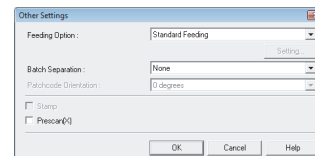

Basic Setup Dialog Box

This dialog box allows you to make settings for the basic scanning conditions.

The items you can set differ depending on the application program you use. Make the settings as needed for the screen actually displayed.

■ Types of Basic Setup Dialog Box

There are the following types of Basic Setup dialog box.

Basic Setup Dialog Box (ISIS Driver)

This dialog box is displayed for ISIS-compatible application programs (CapturePerfect, etc.).

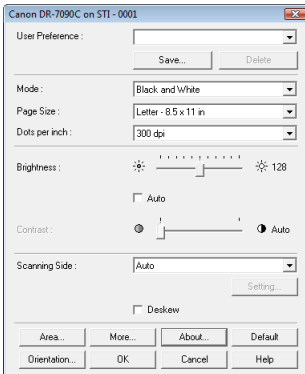

Basic Setup Dialog Box (TWAIN Driver)

This dialog box is displayed for TWAIN-compatible application programs (Job Registration Tool).

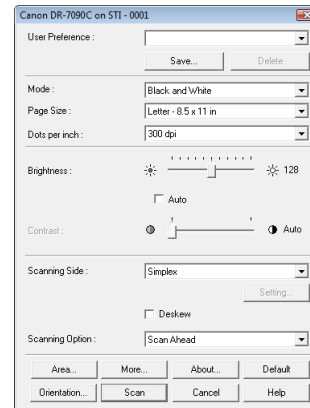

- The [Scanning Option] is a function for setting the TWAIN driver, so it does not appear with the ISIS driver.
- When you use a TWAIN-compatible application program that scans from the settings dialog box, the [Scan] button is displayed instead of the [OK] button.

■ Settings of Basic Setup Dialog Box

You can configure the following settings in the Basic Setup dialog box.

User Preference

Click [Save] to open the [Save User Preference] dialog box.

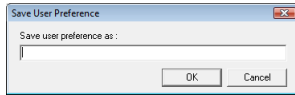

The [Save User Preference] dialog box saves the current settings under an assigned name.

You can select the name of a saved set of user preferences in the list box to load those settings into the dialog box.

IMPORTANT

Assigned names can consist of up to 32 characters.

Mode

Select the mode for scanned images.

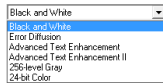

Hint

- Advanced text enhancement modes are good for scanning documents with a background color or design behind text as black and white images, and remove or process the surrounding background to enhance the text for easy reading. Two advanced text enhancement modes are provided to suit different background types. Select the mode that seems to best suit your document. We recommend confirming an image by prescanning the first page.
- When saving an image file in JPEG format, select [256-level Gray] or [24-bit Color].

[Black and White]

Use this mode to scan text and line drawing documents as black and white (binary) images.

[Error Diffusion]

Use this mode to scan documents containing photos as black and white (binary) images.

[Advanced Text Enhancement]

Use this mode to scan documents with a dark or non-uniform (pattern) background.

Hint

- If the background is uniform, it is removed where it surrounds the text.
- If the background is non-uniform, such as a pattern, it is processed to enhance text readability.

[Advanced Text Enhancement II]

Use this mode to scan documents with a light uniform background and low-contrast text.

Hint

- The background in tight spaces around text may not be removed.
- Documents with low-contrast text can be made more readable by adjusting the contrast.
- If the background is non-uniform, such as a pattern, the background remains visible in the image, and text may be hard to read.

[256-level Gray]

Scans documents such as photos as grayscale images.

[24-bit Color]

Scans documents such as color photos as full-color images.

Page Size

Select the page size of the document to be scanned.

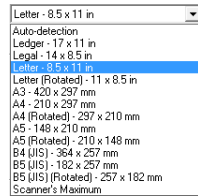

! IMPORTANT

- Select [Auto-detection] to scan the following kinds of documents.
 - Documents of a non-standard size
 - Documents including mixed page sizes
 - When using the Long document mode (See “Long Document Mode” on p. 4-2)
- When [Auto-detection] is selected, area settings in the Scan Area dialog box are disabled.
- The [Auto-detection] process may malfunction in the following situations. If this occurs, select a standard size such as [A4] or [Letter], or click the [Area] button to create a custom page size. (See “Scan Area Dialog Box” on p. 8-9.)
 - When scanning a page that has dark areas around the edges
 - When the brightness setting is incorrect
 - When the Custom setting is selected in the Gamma Settings dialog box
- Some application programs do not support auto-page-size detection.

Dots per inch

Select the scanning resolution.

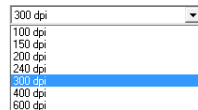

💡 Hint

Higher resolutions provide clearer images, but produce larger files.

Brightness

Adjust the brightness of images to be scanned.

💡 Hint

- If images are too dark or if text on the back bleeds through, you can drag the slider to the right to increase the setting. If images are too light, drag the slider to the left to decrease the setting.
- When the [Custom] check box in the Gamma Settings dialog box is selected, the [Brightness] setting is grayed out and adjusted automatically.
- When [Black and White] is selected for the scanning mode, the [Auto] check box is enabled and the brightness is adjusted automatically when the check box is selected. You can adjust the automatically adjusted brightness by moving the slider left or right.

Contrast

Adjust the contrast of scanned images.

💡 Hint

When the [Custom] check box in the Gamma Settings dialog box is selected, [Contrast] is set to [Auto] automatically. In such a case, [Contrast] is grayed out and cannot be set.

Scanning Side

Select which page side(s) to scan.



[Auto]

If there is a document in the feeder, one side of the document in the feeder is scanned. If there is no document in the feeder, the document on the flatbed is scanned.

💡 Hint

To scan both sides of the document in the feeder, select [Duplex].

[Flatbed]

Scans the document on the flatbed.

[Simplex]

Scans the front side of documents.

[Duplex]

Scan both sides of documents.

[Skip Blank Page]

As each document page is scanned, whether the scanned image is blank is judged, and if blank, the image is not saved.

- When [Scan Options] is set to [Scan Single Page] for the TWAIN driver, [Duplex] and [Skip Blank Page] are not displayed for [Scanning Side]. (See “[Scanning Options] (TWAIN Driver Only)” on p. 8-8.)
- Selecting [Skip Blank Page] enables the [Setting] button, and clicking the button opens the [Blank Skip Setting] dialog box. If blank pages are not skipped or if non-blank pages are skipped, adjust the content density.

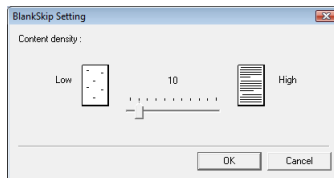

Adjust the content density according to the document content.

- When blank pages are not skipped, increase the content density.
- When non-blank pages are skipped, reduce the content density.
- The Skip Blank Pages function may not work properly if the [Custom] setting is enabled in the Gamma Settings dialog box.
- If the application program provides its own simplex/duplex scanning side setting, select Simplex in this dialog box.

[Deskew] Check Box

The Deskew function detects slanted document pages and straightens the scanned images.

! IMPORTANT

The Deskew function does not work properly in the following situations. Disable Deskew in these cases.

- When scanning a page with a dark area near an edge
- When scanning a glossy or reflective document
- When the brightness setting is incorrect
- When the Custom setting is selected in the Gamma Settings dialog box
- When the area to scan is specified in the Scan Area dialog box

[Scanning Options] (TWAIN Driver Only)

Specify the operation for scanning continuously with a TWAIN-compatible application.

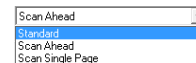
**[Standard]**

Output each scanned page before scanning the next page.

[Scan Ahead]

Scan pages continuously. Scanning speed is faster than [Standard].

[Scan Single Page]

Scan only one page of the document.

! IMPORTANT

When using [Apply first page size to next pages] of the Advanced Settings dialog box, set [Scan Options] to [Scan Ahead].

Buttons

[Area] button

Open the [Scan Area] dialog box to specify the area to scan. (See “Scan Area Dialog Box” on p. 8-9.)

The [Area] button is not displayed if the application program provides its own function to specify the scan area.

[More] Button

Click this button to display the Advanced Settings dialog box. (See “Advanced Settings Dialog Box” on p. 8-12.)

[About] button

Click this button to display the driver version information.

[Default] button

Clicking this button returns all settings to their default values.

[Orientation] Button

Click this button to display the Orientation Settings dialog box. (See “Orientation Settings Dialog Box” on p. 8-11.)

[OK] button

Click this button to accept changes and close the dialog box.

[Cancel] button

Click this button to cancel any changes and close the dialog box.

[Help] button

Click this button to display help for this dialog box.

Scan Area Dialog Box

This dialog box appears when you click the [Area] button in the scan settings dialog box of an application or in the Basic Setup dialog box of the scanner driver.

This dialog box allows you to define the area of the document page to scan on a selected page size, and register non-standard document page sizes.

The Scan Area dialog box is different for the ISIS driver and TWAIN driver. For the TWAIN driver, two dialog box types may be displayed, depending on the application program used.

Scan Area Dialog Box (ISIS Driver)

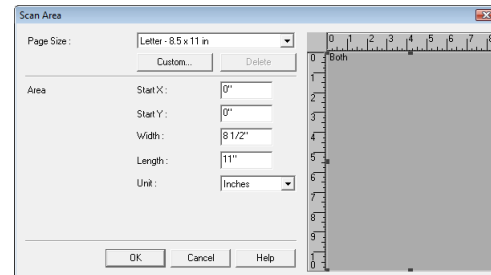

Scan Area Dialog Box (TWAIN Driver)

The area window and [Preview] button appear with application programs that display the [Scan] button in the settings dialog box.

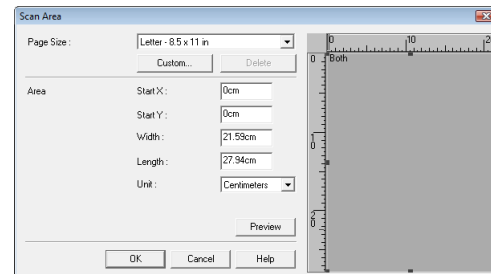

The Area window and [Preview] button are not displayed when using application programs like Job Registration Tool that display the [OK] button in the settings dialog box.

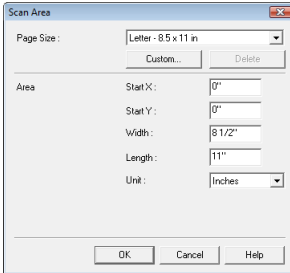

Page Size

Select the size of the document to scan. This setting is linked to the [Page Size] setting in the Basic Setup dialog box.

Hint

Clicking the [Custom] button displays the [Custom Page Size] dialog box, where non-standard page sizes can be registered as custom page sizes.

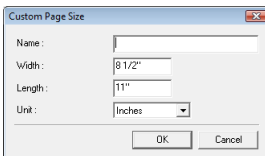

Area

Select the area to be scanned.

IMPORTANT

- The specifiable range for the scan area is from 64 x 64 pixels up to the selected [Page Size].
- If Auto-detection is selected for [Page Size], or [Text Orientation Recognition] is enabled in the Advanced Settings dialog box, you cannot specify the scan area.
- When scanning both sides of a page, the scan area settings apply to both front and back sides. Settings cannot be made separately for the front and back sides.

Area Window

The size indicated for the area window corresponds to the page size setting, and the area within the window changes in accordance with the area setting.

Hint

- You can also specify the scan area by dragging the frame or a part inside the area window with the mouse.
- With CapturePerfect, the last scanned image appears in the area window.

Buttons

[Preview] Button (TWAIN Driver Only)

Load the document and then click the [Preview] button to scan one document page and display its preview image in the area window.

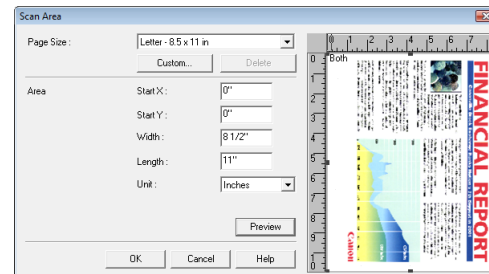

[OK] button

Click this button to accept changes and close the dialog box.

[Cancel] button

Click this button to reject changes and close the dialog box.

[Help] button

Click this button to display help for this dialog box.

Orientation Settings Dialog Box

This dialog box appears when you click the [Orientation] button in the Basic Setup dialog box or in the extended version of the Advanced Settings dialog box (for the ISIS driver).

This dialog box allows you to make settings for rotating the scanned images.

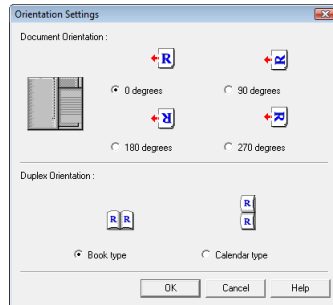

Document Orientation

Specify a rotation angle to correct the orientation of images.



Hint

- Scanned images are rotated as follows according to the orientation of loaded documents and the selected angle.

Flatbed Document: Face Down				
Feeder Document: Face Up				
Document Orientation				
Image Rotation (Clockwise)	0 degrees	90 degrees	180 degrees	270 degrees
Output Image				

- Select [90 degrees] for [Document Orientation] when scanning in Long Document mode.

Duplex Orientation

Specify the mode in accordance with the orientation of the front and back sides of the document when scanning both sides of a document.

[Book type]

Specify this mode when scanning a document with the top and bottom of the front and back sides oriented in the same direction.



Front Back

[Calendar type]

Specify this mode when scanning a document with the top and bottom of the front and back sides oriented in the opposite direction. The image of the scanned back side is rotated 180 degrees and then saved.

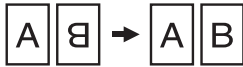

Front Back

Buttons

[OK] button

Click this button to accept changes and close the dialog box.

[Cancel] button

Click this button to reject changes and close the dialog box.

[Help] button

Click this button to display help for this dialog box.

Advanced Settings Dialog Box

This dialog box appears when you click the [More] button in the Basic Setup dialog box, when scanning from an ISIS-compatible application, and when the ISIS driver is called from a particular dialog box in order to make settings.

This dialog box allows you to make advanced settings for scanning.

The items you can set differ depending on the application program you use. Make the settings as needed for the screen actually displayed.

Types of Advanced Settings Dialog Box

There are the following types of Advanced Settings dialog box.

Advanced Settings Dialog Box (ISIS Driver)

This dialog box is displayed for ISIS-compatible application programs (CapturePerfect, etc.).

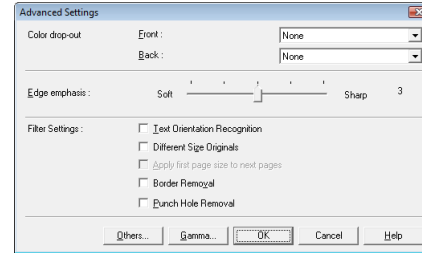

Extended Version of Advanced Settings Dialog Box (ISIS Driver)

This dialog box is displayed when the ISIS driver is accessed from a scanner setting or scanning dialog box belonging to an ISIS-compatible application program. It contains settings that are not supported in the settings dialog box belonging to the application program.

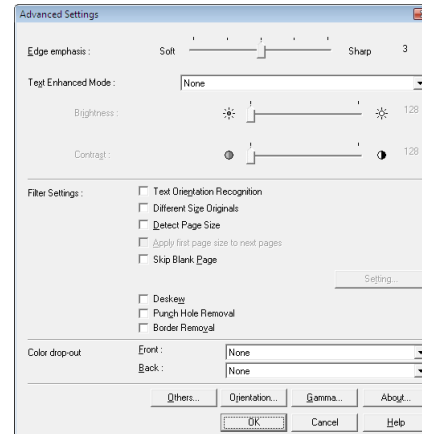

Hint

For details on [Text Enhanced Mode], [Detect Page Size], [Skip Blank Page], and [Deskew], see the descriptions for the following settings.

- [Text Enhanced Mode] → [Mode]
- [Detect Page Size] → [Page Size]
- [Skip Blank Page] → [Scanning Side]
- [Deskew] → [Deskew]

Advanced Settings Dialog Box (TWAIN Driver)

This dialog box is displayed for TWAIN-compatible application programs (Job Registration Tool).

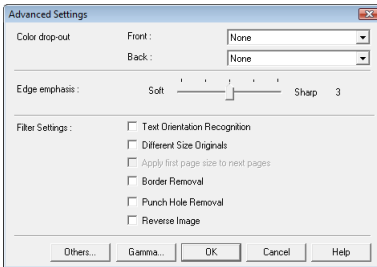

■ Settings of Advanced Settings Dialog Box

You can configure the following settings in the Advanced Settings dialog box.

Color drop-out

These options are enabled for scanning modes other than 24-bit Color, so that you can select a primary color (red, green, blue) or gray to be ignored (dropped out) or enhanced.

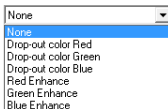

Edge emphasis

Adjust image contours. Move the slider toward Soft to soften image contours, or toward Sharp to sharpen image contours.

[Text Orientation Recognition] Check Box

Select this check box to detect the text orientation in scanned images and rotate the images in 90° increments as needed to normalize text orientation.

Flatbed Document: Face Down				
Feeder Document: Face Up				
Text Orientation				
Output Image				

Different Size Originals

Set this item when scanning with [Single-Pass Dup.] set to [OFF] in the user mode of the scanner.

If a mixture of documents of different sizes is detected when the resolution is set to [600 dpi] and the scanning side setting is set to [Duplex] or [Skip Blank Page], the “Detect Mix Doc.” error message may appear. If it does appear, select this check box.

IMPORTANT

- The feed speed may become slower when [Different Size Originals] is selected.
- When scanning a mixture of documents, load documents of the same paper thickness together.
- When scanning a mixture of documents, load the documents so that they are aligned at the back of the feeder.
- If documents of different widths are loaded and scanned, they may become slanted when scanned.

Apply first page size to next pages

When [Scan Ahead] is selected in the settings of the application program, this setting is enabled and the document size of the first page detected with auto detection is applied to the next pages. This minimizes the reduction in scanning speed caused by the auto detection of document sizes.

IMPORTANT

This setting is not enabled for application programs that do not use the scan ahead setting. In CapturePerfect, [Scan Ahead] is selected.

Border Removal

Select this check box to replace black borders surrounding scanned images with white.

Punch Hole Removal

When scanning a document with punch holes, the holes appear as black spots on the scanned image. Select this check box to remove the black spots from scanned images.

IMPORTANT

If punch holes are located within text or graphics in the document, they may be misidentified as graphics, and may not be removed.

[Reverse Image] Check Box (TWAIN Driver Only)

Select this check box to output images scanned in black and white (binary) with black and white reversed.

IMPORTANT

This is not available when the mode is [256-level Gray] or [24-bit Color].

Buttons

[Others] Button

Click this button to display the Other Settings dialog box.

[Orientation] button (only when opened from the extended version of the Advanced Settings dialog box)

Click this button to display the Orientation Settings dialog box.

[Gamma] Button

Click this button to display the Gamma Settings dialog box.

[About] button (only when opened from the extended version of the Advanced Settings dialog box)

Click this button to display the driver version information.

[OK] button

Click this button to accept changes and close the Basic Setup dialog box.

[Cancel] button

Click this button to reject changes and close the dialog box.

[Help] button

Click this button to display help for this dialog box.

Gamma Settings Dialog Box

This dialog box appears when you click the [Gamma] button in the Advanced Settings dialog box.

This dialog box allows you to change the settings for the gamma correction value.

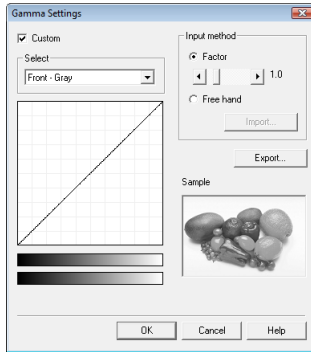

[Custom] Check Box

Select this check box to enable custom settings for gamma correction.

Select

Select the side and color for the custom setting.

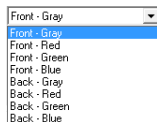

Hint

The color bar and color of the sample image are changed to show the specified color.

Input method

Select the setting method for gamma correction.

[Factor]

Move the slider to the left or right to adjust the gamma correction factor between 0.2 and 5.0.

- The gamma correction value, gamma curve graph, and sample image color are interlinked.
- Clicking a point in the gamma curve graph with your mouse changes the gamma curve and color of the sample image to match that point.
- You can also move the gamma curve by dragging it with the mouse.

[Freehand]

The output value for a particular input value in the gamma table can be specified with the mouse.

- Click any point in the gamma curve graph to set that point as an output value.
- Drag the mouse over the gamma curve graph to set the output value according to the mouse movement.

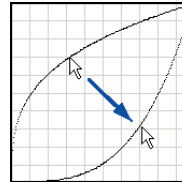

[Import] Button

Click this button to load gamma table data (*.pxg file) that was previously exported with the [Export] button.

Imported gamma data is reflected in the gamma curve graph.

[Export] Button

Click this button to export the set gamma correction value to a file as gamma table data (*.pxg).

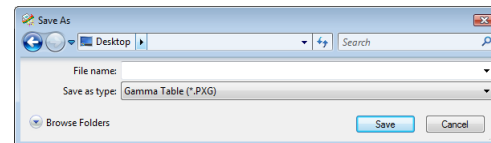

**Hint**

Gamma table data (*.pxg files) consists of 258 lines of text used to create the desired image data. Refer to “Gamma Table Files” in the ISIS/TWAIN driver Help for details.

Buttons

[OK] button

Click this button to accept changes and close the Basic Setup dialog box.

[Cancel] button

Click this button to reject changes and close the dialog box.

[Help] button

Click this button to display help for this dialog box.

Other Settings Dialog Box

This dialog box appears when you click the [Others] button in the Advanced Settings dialog box.

This dialog box allows you to make settings for the feed method, stamps, and prescan.

The items you can set differ depending on the application program you use. Make the settings as needed for the screen actually displayed.

Types of Other Settings Dialog Box

There are the following types of Other Settings dialog box.

Other Settings Dialog Box (ISIS Driver)

This dialog box is displayed for ISIS-compatible application programs (CapturePerfect, etc.).

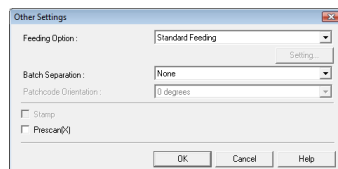
**Other Settings Dialog Box (TWAIN Driver)**

This dialog box is displayed for TWAIN-compatible application programs (Job Registration Tool).

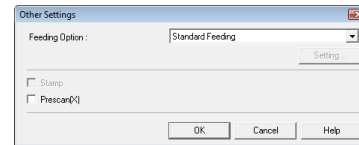
**Hint**

In the case of both ISIS and TWAIN, the [Stamp] check box only appears when an optional stamp unit is installed.

Settings of Other Settings Dialog Box

You can configure the following settings in the Other Settings dialog box.

Feeding Option

Select the feeding method for documents.

[Standard Feeding]

If scanning is started from an application program, the document loaded in the feeder or on the flatbed is scanned. Scanning ends when all pages of the document have been fed.

[Panel Feeding]

If scanning is started from an application program, the document loaded in the feeder or on the flatbed is scanned. After that, you can continue scanning documents by loading a new document in the feeder or on the flatbed and then pressing the Start key on the scanner. To finish scanning, press the Stop key on the scanner or stop scanning from the application program.

[Automatic Feeding]

Once scanning is started from an application program, whenever a document is loaded in the feeder, the scanner automatically detects it and begins scanning. To finish scanning, press the stop button on the scanner or stop scanning from the application program.

Selecting this item enables the [Setting] button. Click this button to display the [Scan Wait Setting] dialog box, where you can specify the wait time before feeding starts.

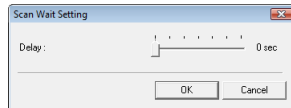

In this dialog box, the time from the detection of a document until feeding starts can be specified from 0 to 60 seconds by dragging the slider left and right.

! IMPORTANT

- The [Feeding Option] setting may be restricted as follows depending on the [Scanning Side] setting in the Basic Setup dialog box (or the scanning side setting in the settings dialog box belonging to an ISIS-compatible application program).
 - When [Scanning Side] is set to [Flatbed], [Automatic Feeding] is not displayed for [Feeding Option].
 - When [Scanning Side] is set to [Auto] and [Feeding Option] is set to [Automatic Feeding], the operation is as follows when scanning is started.
 - If a document is loaded in the feeder, it is scanned.
 - The flatbed enters the wait state (the operation is the same as when [Panel Feeding] is selected for [Feeding Option]). If a document is loaded on the flatbed and then the Start key is pressed, scanning starts.
 - Clicking the Stop key ends scanning.
- Use [Panel Feeding] and [Automatic Feeding] of [Feeding Option] when you want to divide and then scan a document that cannot be loaded in the feed inlet in one go, or when [Batch Separation] is set to [Auto] or [Panel] and you want to use the batch separation function.

Batch Separation (ISIS Driver Only)

Select the timing for batch separation for when batch separation is enabled in the application program and scanning is started.

The options differ depending on the feeding option setting.

- With the [Standard Feeding] is selected for Feeding Option

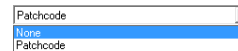

- With the [Panel Feeding] or [Automatic Feeding] is selected for Feeding Option

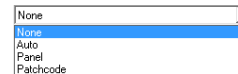

[None]

Batch separation is not performed.

[Auto]

When [Feeding Option] is set to [Panel Feeding], batches are separated each time the Start key on the scanner is pressed.

When [Feeding Option] is set to [Automatic Feeding], batches are separated each time a document is loaded in the feeder.

[Panel]

Batches are separated whenever the New File key on the scanner is pressed.

[Patchcode]

Batches are separated whenever a patchcode sheet is detected between documents. For details, see [“Using Patchcode Sheets” on p. 3-19](#).

! IMPORTANT

When Multi-Stream is enabled in the application program, [Patchcode] is not displayed.













Patchcode Orientation (ISIS Driver Only)

This function is enabled when batch separation is set to [Patchcode]. Set the orientation to match that of the patchcode of the patchcode sheet.



Hint

[Patchcode Orientation] must be set as follows to match that in the document.

Flatbed Document: Face Down				
Feeder Document: Face Up				
Patchcode Sheet				
Patchcode Orientation	0 degrees	90 degrees	180 degrees	270 degrees

Stamp

This function is for affixing the scanned stamp to scanned documents in the feeder, and is displayed when the optional stamp is installed.

Select this check box to affix the scanned stamp to following position of scanned documents.

- Stamp side: Scanned side(s) (both sides when both sides are scanned)
- Stamp position: A position approximately 0.4" (10 mm) from the end at the rear in terms of the feed direction
- Stamp pattern: ⊕ (Diameter of approximately 0.1" (3 mm))

Hint

The pattern and position of the stamp cannot be changed.

Prescan

Prescan and display the first document page in the Prescan window when scanning is started. Continue scanning after you confirm or adjust the brightness and contrast of the scanned image in the Prescan window.

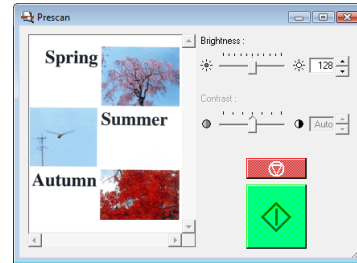

Buttons

[OK] button

Click this button to accept changes and close the Basic Setup dialog box.

[Cancel] button

Click this button to reject changes and close the dialog box.

[Help] button

Click this button to display help for this dialog box.

Chapter 9 Job Registration Tool Settings

1. Before Use.....	9-2
Job Function.....	9-2
Starting Job Registration Tool.....	9-2
2. Job Registration Tool.....	9-3
3. Settings Dialog Boxes.....	9-4
[New/Editing] Dialog Box.....	9-4
[Admin] Dialog Box.....	9-9

1. Before Use

Job Registration Tool is an application program for registering jobs that can be executed from the Job key on the control panel. This chapter describes the settings for Job Registration Tool. For details on Job Registration Tool, see “About the Job Function” on p. 3-11.

Job Function

The job function is for using the [Job] key on the control panel to select and execute jobs registered by Job Registration Tool, and allows you to execute scanning without using a scanning application.

Hint

- The scanning conditions, file format of the image data to be saved, and save destination are registered to a job, and the image data scanned with the job function is processed using the conditions registered to the job.
- Up to 99 jobs can be registered with Job Registration Tool.

Starting Job Registration Tool

Follow the procedure below to start Job Registration Tool.

1. From the Windows task bar, click [Start] → click [All Programs] → [Canon DR-7090C] → [Job Registration Tool].

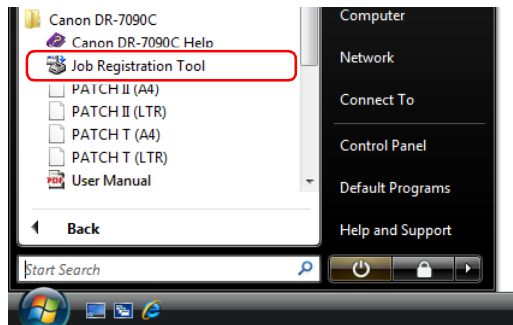

Job Registration Tool starts.

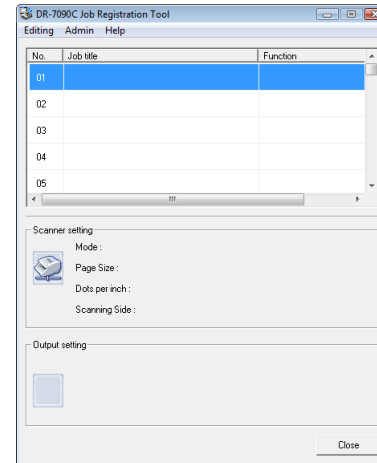

2. Job Registration Tool

Job Registration Tool consists of the main window below and the [New/Editing] and [Admin] dialog boxes. For details on the dialog boxes, see the description of each dialog box.

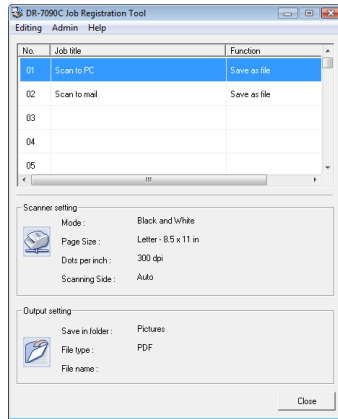

Menu Bar

[Edit] Menu

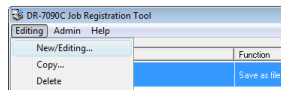

Select a job from the job list, and register a new job or edit, copy, or delete the job. (See “[New/Editing] Dialog Box” on p. 9-4.)

Hint

- If you select a registered job, [Copy] and [Delete] are enabled. Selecting [Copy] displays the following dialog box. Specify the job number to copy to and job title, and click the [OK] button to copy the job to the specified job number.

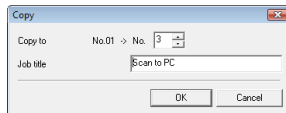

- Selecting [Delete] displays a confirmation message.
- The items of the [Edit] menu are also displayed in a submenu when you right-click a job.

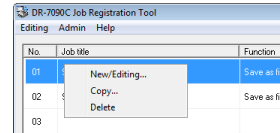

[Admin] Menu

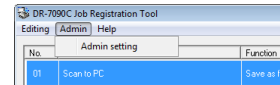

Open the [Admin] dialog box to configure settings for monitoring the storage folder for images and backing up job data. (See “[Admin] Dialog Box” on p. 9-9.)

[Help] Menu

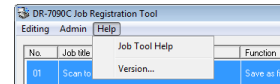

Display the help and version of Job Registration Tool.

Job List

Displays the job numbers (01 to 99) and job titles.

Job Information

Displays the information for the job selected in the job list.

[Close] Button

End Job Registration Tool.

3. Settings Dialog Boxes

The settings dialog boxes of Job Registration Tool include the [New/Editing] dialog box and [Admin] dialog box. For details, see the description of each dialog box.

[New/Editing] Dialog Box

In the [New/Editing] dialog box, you can register new jobs and edit registered jobs. Depending on the [Function] setting, the dialog box displayed will vary as follows.

Save as file

Allows you to save scanned images on a specified computer.

The screenshot shows the 'New/Editing' dialog box with the following settings:

- No. 1
- Job title: [Empty text box]
- Function: Save as file
- Scan and save documents to PC.
- Scanner setting: [Setting...]
- Save to Pictures folder
- Save in folder: [Empty text box] [Browse...]
- File name: [Empty text box]
- File type: PDF [Setting...]
- [Access setting...]
- [OK] [Cancel]

Print

Allows you to print scanned images on a specified printer.

The screenshot shows the 'New/Editing' dialog box with the following settings:

- No. 1
- Job title: [Empty text box]
- Function: Print
- Scan and print documents.
- Scanner setting: [Setting...]
- Printer: Canon LASER SHOT LBP-1810 [Printer setting...]
- Print format: Actual size Fit to paper
- [OK] [Cancel]

Send by E-Mail

Allows you to send scanned images as e-mail attachments.

The screenshot shows the 'New/Editing' dialog box with the following settings:

- No. 1
- Job title: [Empty text box]
- Function: Send by E-Mail
- Scan and send documents via E-mail.
- Scanner setting: [Setting...]
- Mail address: [Empty text box] [Add...]
- Reply-to address: [Empty text box]
- Subject: [Empty text box]
- Text: [Empty text area]
- Save Image
- Save to Pictures folder
- Save in folder: [Empty text box] [Browse...]
- File name: [Empty text box]
- File type: PDF [Setting...]
- [Access setting...]
- [OK] [Cancel]

Launcher

Allows you to start applications specified in the Windows event function settings.

The screenshot shows the 'New/Editing' dialog box with the following settings:

- No. 1
- Job title: [Empty text box]
- Function: Launcher
- Launcher
- Scanner setting: [Setting...]
- [OK] [Cancel]

 **Hint**

The setting items that appear in the [New/Editing] dialog box vary depending on the [Function] setting. (See “[Function]” on p. 9-5.)

Function Setting Item	Save as file	Print	Send by E-Mail	Launcher
No.	✓	✓	✓	✓
Job title	✓	✓	✓	✓
Scanner setting	✓	✓	✓	✓
Mail address	–	–	✓	–
Save image	–	–	✓	–
Save to My Pictures folder	✓	–	✓	–
Save in folder	✓	–	✓	–
File name	✓	–	✓	–
File type	✓	–	✓	–
Access setting	✓	–	✓	–
Printer	–	✓	–	–
Print format	–	✓	–	–

✓ : available for setting, – : not available for setting

■ Opening [New/Editing] Dialog Box

Double-click a job number displayed in the job list to open the [New/Editing] dialog box.

 **Hint**

The [New/Editing] dialog box can also be opened in the following ways.

- Right-click the job number you want to register and click [New/Editing] in the submenu.

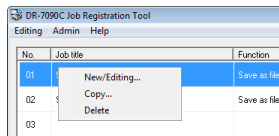

- Select the job number you want to register and click [New/Editing] in the [Edit] menu.

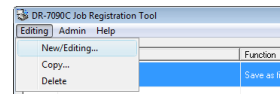

■ Settings of [New/Editing] Dialog Box

You can configure the following settings in the [New/Editing] dialog box.

No.

Displays the selected job number.

Job title

Enter the job title to display on the display panel of the control panel.

 **Hint**

A maximum of 29 alphanumeric single-byte characters can be entered for a job title.

[Function]

Specifies the function to be assigned to a job. The contents of the [New/Editing] dialog box depend on the specified function. (See “[New/Editing] Dialog Box” on p. 9-4.)

 **Hint**

Applications started by the [Launcher] function are those specified in the Windows “Events” function settings. (See “Setting the Events Function” on p. 3-13.)

Scanner Setting

Click the [Setting] button to configure the scanner settings.

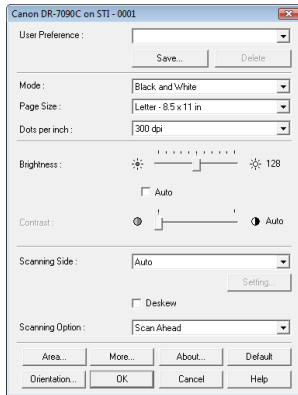
**[Mail address]**

Enter the e-mail address of the recipient for the scanned image files.

[Add] button

To send to multiple recipients, click the [Add] button. The following dialog box appears for entering additional recipient e-mail addresses.

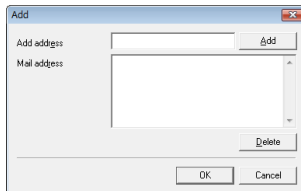

[Reply-to address]

Enter the e-mail address of the sender.

[Subject]

Enter the subject for sent mail.

[Text]

Enter the text message for sent mail.

[Save Image]

Select this to save scanned images.

[Save to My Pictures folder] Check Box

Select this check box to save image files to the My Pictures folder of the user logged in to Windows.

**Hint**

- The name displayed for My Pictures differs depending on the version of Windows you are using.
Example: My Pictures, Pictures
- When this check box is not selected, the [Save in folder] and [Access setting] buttons are enabled.

Save in folder

When the [Save to My Pictures folder] check box is not selected, this is enabled for you to specify any name for the folder in which to save scanned images.

File name

Enter a name for the files to save.

**Hint**

- File names may consist of up to 32 alphanumeric characters.
- A time stamp is appended to the file name to indicate the time of scanning.

File type

Select the file format for the files to be saved.

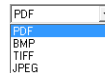

When multi-page documents are scanned, image files are created as follows in accordance with the file format.

PDF: All pages are saved in a single image file.

BMP: Each page is saved in a separate image file.

TIFF: You can select the method for saving when multiple page documents are scanned in the [TIFF Setting] dialog box displayed by clicking the [Setting] button.

JPEG: Each page is saved in a separate image file.

Hint

When a mode other than [256-level Gray] or [24-bit Color] is selected, an error is displayed if [JPEG] is selected when you click the [OK] button. If the error appears, change the file format or scanner mode.

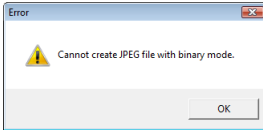
**[Setting] Button**

This button is enabled to display the corresponding settings dialog box when the [TIFF] or [PDF] file format is selected. (See p. 9-7 and p. 9-8.)

[Access setting] Button

This button is enabled when the [Save to My Pictures folder] check box is not selected, and allows you to enter the user name and password required to access the shared network folder specified for [Save in folder].

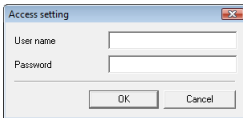

Access to shared network folders may be restricted to users with certain access permission. In this case, users cannot access the shared folder without entering the correct user name and password. Confirm the access rights set for the shared network folder with the network administrator, then enter the user name and password.

[Printer]

Click the [Printer setting] button to select the printer for scanned images.

[Print format]

To print at the same size as the manuscript, select [Actual size].

If the size of the manuscript is larger than the printing page size, select [Fit to paper] to scale images to fit the printed paper.

■ Settings of [PDF setting] Dialog Box

You can configure the following settings in the [PDF setting] dialog box.

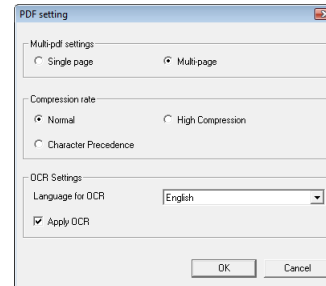
**Multi-PDF settings**

Select the method for saving PDF files when scanning multi-page documents.

Hint

- Select [Single page] to save each page of the scanned document as one PDF file.
- Select [Multi-pages] to save all pages as one PDF file.

Compression rate

Select the compression rate for PDF files.

Hint

- Select [Normal] to save files with normal compression.
- Select [High Compression] to save files with high compression. Although the file size is reduced, image quality may be slightly degraded.
- Select [Character Precedence] to ensure readability is not reduced by saving files with the parts other than the text compressed.

! IMPORTANT

The Compression rate setting is enabled when the scanner is set to [256-level Gray] or [24-bit Color] mode. When [Black and White] or [Error Diffusion] binary image scanning mode is selected, file size depends on the content of the scanned document.

Language for OCR

When the [Apply OCR] check box is selected, the target language for OCR can be selected in the list box.

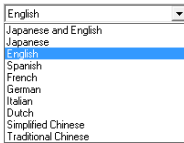

Characters within document images are recognized as text and saved as appended text data in PDF (*.pdf) files.

■ Settings of [TIFF setting] Dialog Box

You can configure the following settings in the [TIFF setting] dialog box.

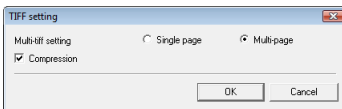
**Multi-tiff setting**

Select the method for saving image files when scanning multi-page documents.

💡 Hint

- Select [Single page] to save each page as one image file.
- Select [Multi-page] to save all pages as one image file.

[Compression] Check Box

Select this check box to compress images saved to files. Black and white (binary) images are compressed in CCITT Group 4 format, and grayscale and color images in JPEG format. When this check box is not selected, the saved files are much larger.

💡 Hint

- CCITT Group 4 is a compression format designed for data communications (such as with fax devices) of black and white (binary) images.
- JPEG is a compression format for saving grayscale and color images. When the [Compression] check box is selected, a standard level of JPEG compression is applied.

💡 Hint

If your application program does not support the above compression formats, you may be unable to open scanned image files. In this case, disable [Compression] when scanning.

■ Settings of [JPEG File Setting] Dialog Box

You can configure the following settings in the [JPEG File Setting] dialog box.

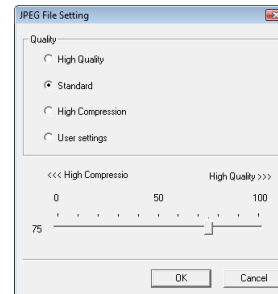
**Quality**

Select the image quality for JPEG files.

💡 Hint

- Select [High Quality] to save files with high quality. Although image quality is high, the file size becomes larger.
- Select [Standard] to save files with normal compression.
- Select [High Compression] to save files with high compression. Although the file size is reduced, image quality may be slightly degraded.
- Select [User settings] to enable the slider and set the quality manually.

[Admin] Dialog Box

The [Admin] dialog box allows you to configure settings for monitoring the storage folder for images, settings for the mail server and settings for backing up job data.

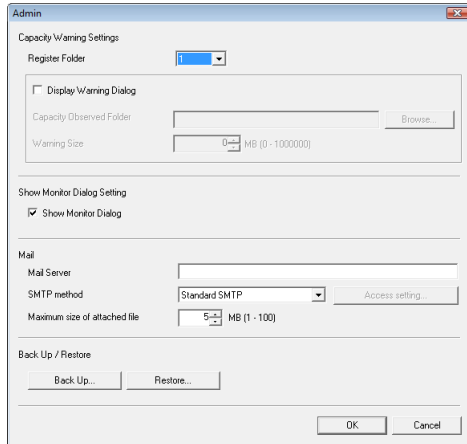

■ Opening [Admin] Dialog Box

Click [Admin setting] in the [Admin] menu to open the [Admin] dialog box.

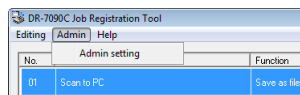

■ Capacity Warning Settings

The capacity warning settings allow you to specify in advance the folder for saving image files, and the space to be available for saving files. If the space required to save a file will exceed the specified warning size when starting to scan or while scanning, a warning message appears.

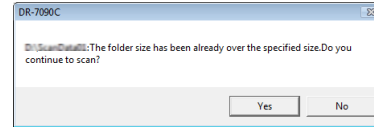

Register Folder

A warning size (capacity) can be specified for up to five folders. Select the number (1 to 5) of the folder to be registered in [Register Folder].



[Display Warning Dialog] Check Box

Select this check box when you want to limit the space available for the selected registration folder number, and specify the folder for which to monitor the capacity limit and set the size at which to output a warning.

[Capacity Observed Folder]

Specify a folder for which to limit space available.

[Warning Size]

Enter the maximum total size for all files saved to the specified folder.

! IMPORTANT

- When saving to removable storage media such as CD-R, specify the maximum capacity of the media.
- When folder monitoring ([Display Warning Dialog]) is enabled, a warning message appears when scanning is started if the total size of the files in the specified folder exceeds the specified limit.
- If a warning message appears, follow the instructions in the message to either continue scanning or change the save destination first.

■ Show Monitor Dialog Setting**[Show Monitor Dialog] check box**

Check this box to display scanning progress in a dialog box during scanning.

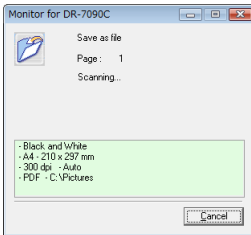
**■ Mail Server Settings**

Make appropriate settings to suit your mail server.

[Mail Server]

Enter the IP address of the mail server.

[SMTP method]

Select your mail server's handing method protocol.

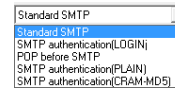

If you select anything other than [Standard SMTP], click the [Access setting] button and enter the user's account access information as required by the mail server.

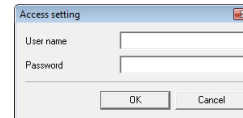
**[Maximum size of attached file]**

When you specify [Send by E-Mail], enter the maximum size limit for image file attachments. When the scanned image size reaches the specified maximum, a message appears and scanning stops.

! IMPORTANT

- Contact your mail server administrator if you are uncertain about any mail server settings.
- Choose a maximum attachment file size that does not exceed the corresponding setting on your mail server.

■ Job Back Up Settings

Set this function to back up the registered jobs when the same job is to be executed in a different environment, such as occurs when multiple users log on to Windows or when multiple scanners are used.

[Back Up] Button

Write a backup file (*.reg) of registered job data to any folder.

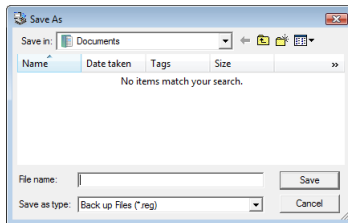

[Restore] Button

Read an output backup file (*.reg), and restore the job data.

Hint

If the currently registered job number is the same as that of an existing backup file, the existing backup file is overwritten by the registered job.

Chapter 10 Practical Examples

1. About Basic Condition Settings	10-2
Confirming Basic Conditions for Scanning.....	10-2
2. Practical Examples	10-4
Scanning Documents of Unregistered Page Sizes	10-4
Specifying Scanning Area	10-5
Configuring Scanner Settings According to Purpose.....	10-5
Registering Your Settings	10-8

1. About Basic Condition Settings

This section provides an overview of the basic setting items that are the minimum requirements when configuring the scanner settings. For details on settings, see [Chapter 8 “ISIS/TWAIN Driver Settings”](#).

Confirming Basic Conditions for Scanning

When you scan a document, make sure to confirm the [Mode], [Page Size], [Dots per inch], and [Scanning Side] basic conditions in the Basic Setup dialog box.

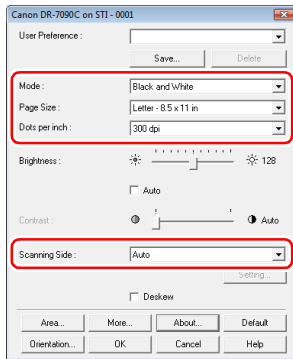

Mode

Select the scanning mode.

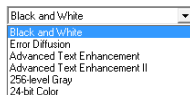

Hint

[Advanced Text Enhancement] removes or processes the background color and background surrounding text to enhance the text for easy reading.

Page Size

Select the paper size in accordance with the document to be scanned.

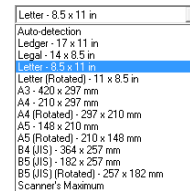

Hint

If [Auto-detection] is selected, the edges of the document are detected and images that match the size of the document are saved.

Dots per inch

Select the scanning resolution.

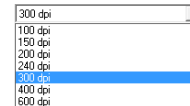

Hint

Higher resolutions provide clearer images, but produce larger files.

Scanning Side

Select which page side(s) to scan.



Auto
Auto
Flatbed
Simplex
Duplex
Skip blank page

Hint

- To scan using the flatbed, set the scanning side to [Flatbed] or [Auto].
- If the scanning side is set to [Auto], documents placed in the feeder tray will be scanned. If there are no documents in the feeder tray, the flatbed will be scanned.
- If the scanning side is set to [Skip Blank Page], the images of blank pages are deleted when the images are saved.

2. Practical Examples

This section provides an overview of the basic setting items that are the minimum requirements when configuring the scanner settings. For details on settings, see [Chapter 8 “ISIS/TWAIN Driver Settings”](#).

Scanning Documents of Unregistered Page Sizes

Configuring the following settings allows you to scan a document of an unregistered page size.

■ Scanning documents longer than 17.0" (432 mm) (Long Document Mode)

When you want to scan a document that is longer than 17.0" (432 mm), you can enable [Long Document Mode] in the scanner settings and set the page size setting to [Auto-detection] in order to scan documents up to 24.8" (630 mm) long.

1. In User Mode, set [Long Document Mode] of the scanner settings to [ON]. (See “Long Document Mode” on p. 4-2.)

L	o	n	g	D	o	c	u	m	e	n	t
[O	N]		O	F	F				

2. Set [Page Size] to [Auto-detection] in the Basic Setup dialog box.

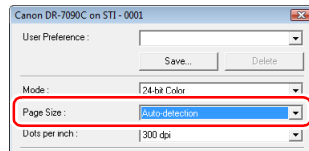

3. Set [Document Orientation] to [90 degrees] and [Duplex Orientation] to [Calendar type] in the Orientation Settings dialog box.

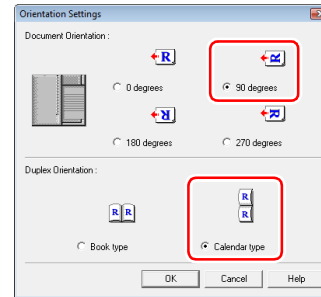

4. Select the [Text Orientation Recognition] check box in the Advanced Settings dialog box.

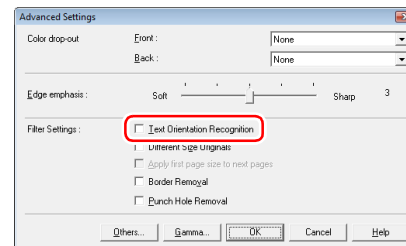

! IMPORTANT

- Long Document Mode is not available if it is not supported by the application program.
- When scanning a long document, load and scan the pages of the document one at a time.
- Some scanning mode and resolution settings may produce incomplete images. If this happens, try decreasing the resolution or, if scanning in color mode, switch to black and white.

■ Registering of non-standard page sizes

You can register a non-standard page size that has not been registered as a page size by naming and registering it as a custom page size in the [Page Size] setting of the Scan Area dialog box, which is opened from the [Area] button in the Basic Setup dialog box. (See p. 8-9.)

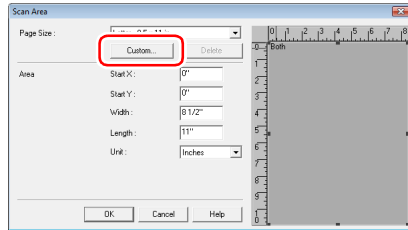

Specifying Scanning Area

Configure the following settings when you want to specify the area of the document to scan.

■ Specifying an area

Specify the area of the document to scan in the Scan Area dialog box. (See p. 8-9.)

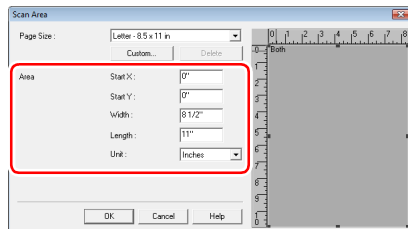

💡 Hint

- With the TWAIN driver, load the document you want to specify the area of and press the [Preview] button to scan the document and display the preview image in the Area panel. You can then specify the area from the displayed preview image.

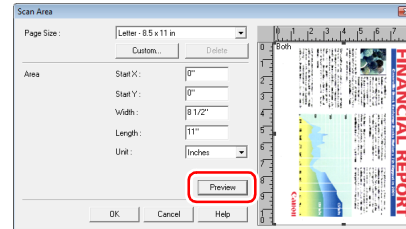

- With CapturePerfect 3.0, the last scanned image appears in the preview window. Scan the document you want to set the area of with [Scan Single Page] in order to display the image in the preview window.

Configuring Scanner Settings According to Purpose

Set the scanning conditions according to the scanning purpose.

■ When you do not want to scan colored lines and characters

Select the color (red, blue, or green) to be ignored (dropped out) in [Color drop-out] in the Advanced Settings dialog box, and that color will be not be scanned. (See p. 8-13.)

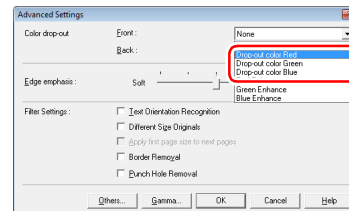

■ When you want to enhance a particular color

Select the color (red, blue, or green) to be enhanced in [Color drop-out] in the Advanced Settings dialog box, and that color will be enhanced.

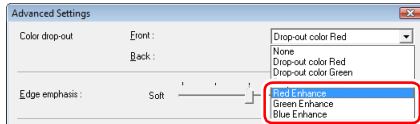

■ When you want to enhance contours in images

Adjust the [Edge emphasis] setting in the Advanced Settings dialog box. (See p. 8-12.)

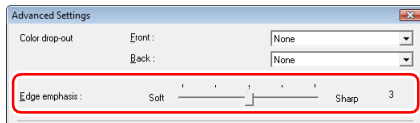

■ When you want to eliminate black borders around scanned images

Select the [Border Removal] check box in the Advanced Settings dialog box. The black borders around the scanned images are removed. (See p. 8-14.)

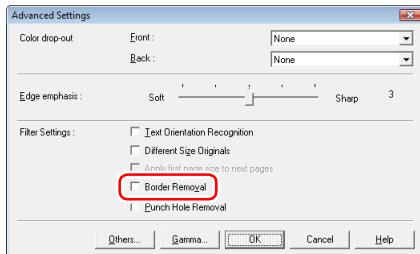

■ When you want to reverse the black and white in scanned images (TWAIN driver only)

Select the [Reverse Image] check box in the Advanced Settings dialog box. This outputs scanned images with black and white reversed. (See p. 8-14.)

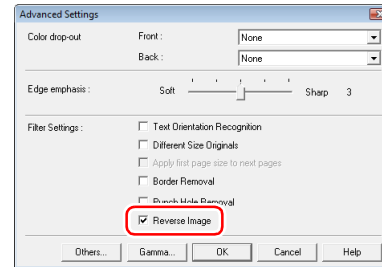

Hint

The ISIS driver does not have a function for reversing black and white.

■ When you want to enhance text that is difficult to read because of factors such as the background of the scanned document

Select [Advanced Text Enhancement] as the mode in the Basic Setup dialog box. The background behind the text is removed or processed so that the text is emphasized for better legibility. (See p. 8-6.)

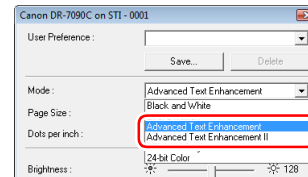

■ **When you want to remove the black spots from scanned images when scanning documents with punch holes**

Select the [Punch Hole Removal] check box in the Advanced Settings dialog box. The black spots from punch holes in documents are removed from scanned images. (See p. 8-14.)

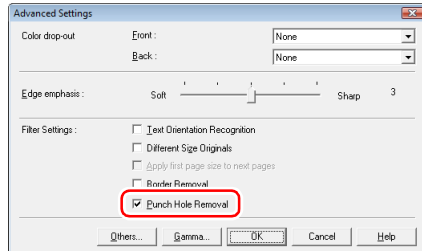

■ **When you want to match the orientation of images to the text when scanning a mixture of pages with different text orientations**

Select the [Text Orientation Recognition] check box in the Advanced Settings dialog box. (See p. 8-13.)

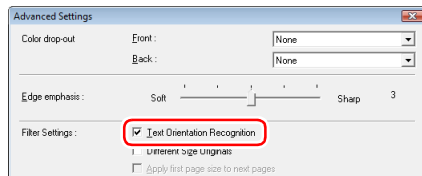

The text orientation on each page is detected, and the scanned image is rotated in 90-degree increments to correct the orientation.

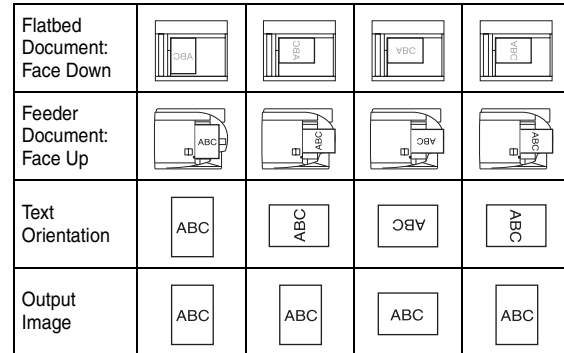

Hint

When [Text Orientation Recognition] is selected, [Document Orientation] is disabled.





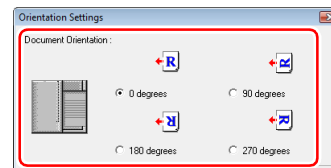











■ **When you want to rotate the images of a document loaded horizontally to correct the orientation**

Specify the rotation angle with [Document Orientation] in the Orientation dialog box. (See p. 8-11.)



 **Hint**

Images are rotated as follows according to the orientation of the loaded document and the selected angle.

Flatbed Document: Face Down				
Feeder Document: Face Up				
Document Orientation				
Image Rotation (Clockwise)	0 degrees	90 degrees	180 degrees	270 degrees
Output Image				

■ When you want to delete the images of the blank pages in two-sided documents

If you set the scanning side setting to [Skip Blank Page] in the Basic Setup dialog box, the images of blank pages in the document are deleted. (See p. 8-8.)

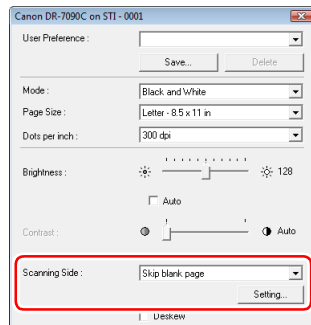
 **Hint**

If [Skip Blank Page] is selected, the [Setting] button is enabled, and you can adjust the level for judging whether pages are blank.

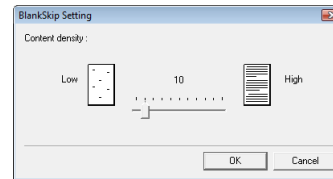

Registering Your Settings

You can register the scanning conditions so that you can use them next time.

■ Registering scanning conditions

Name and register the scanning conditions in [User Preference] in the Basic Setup dialog box. When you want to use the registered scanning conditions, select the registered name to apply the registered scanning conditions.

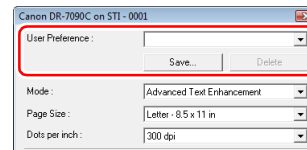



CANON ELECTRONICS INC.

1248, SHIMOKAGEMORI, CHICHIBU-SHI, SAITAMA 369-1892, JAPAN

CANON U.S.A. INC.

ONE CANON PLAZA, LAKE SUCCESS, N.Y. 11042, U.S.A.

CANON CANADA INC.

6390 DIXIE ROAD, MISSISSAUGA, ONTARIO L5T 1P7, CANADA

CANON EUROPA N.V.

BOVENKERKERWEG 59-61, P.O.BOX 2262, 1180 EG AMSTELVEEN, THE NETHERLANDS

CANON LATIN AMERICA, INC.

703 WATERFORD WAY, SUITE 400 MIAMI, FLORIDA 33126, U.S.A.

CANON AUSTRALIA PTY. LTD.

1 THOMAS HOLT DRIVE, NORTH RYDE, SYDNEY. N.S.W, 2113. AUSTRALIA

CANON SINGAPORE PTE. LTD.

1 HARBOUR FRONT AVENUE #04-01, KEPPEL BAY TOWER, SINGAPORE 098632

CANON HONGKONG COMPANY LTD.

19TH FLOOR, THE METROPOLIS TOWER, 10 METROPOLIS DRIVE, HUNGHOM, KOWLOON, HONG KONG.