

Easy Start Guide

Thank you for purchasing the Canon imageFORMULA DR-2580C. This Easy Start Guide describes the procedure for setting up the scanner for use. Follow the procedures outlined in this Easy Start Guide to set up the scanner. Details on using the scanner are described in the User's Guide packaged with the scanner. Before you start using the scanner, make sure to thoroughly read the User's Guide.

STEP 1 Checking the Packing List

When you unpack your scanner, make sure that it contains all of the following accessories. If any of the items listed below are missing or damaged, contact your local authorized Canon dealer or service representative.

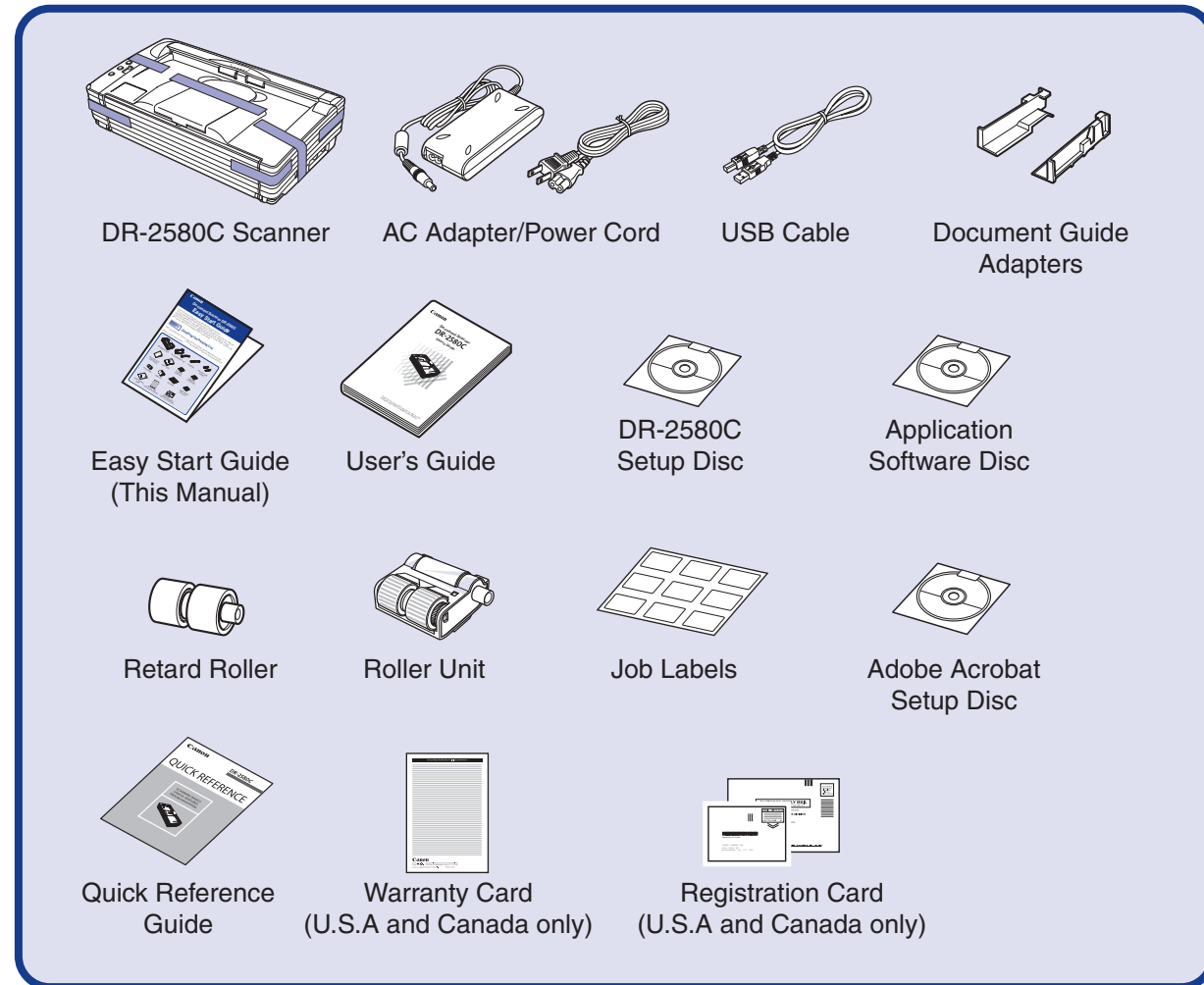

Note

- To use the roller unit and retard roller, you need to install them in the scanner. See "Installing the Rollers".
- The DR-2580C Setup Disc contains the "DR-2580C Scanner Driver" and "CapturePerfect 3.0". For details, refer to "About the Setup Disc" on page 16 of the User's Guide.
- The following application software is included on the application software disk that comes with this product.
 - [Presto! BizCard Reader SE] Name card management software provided with the multi-language OCR made by NewSoft Technology Corp.
 - [OmniPage SE]* Optical character recognition (OCR) software with multiple language support, made by Nuance Communications Inc.
 - [PaperPort® 11]* File management application that makes it easy to store, organize, and retrieve digital documents, made by Nuance Communications Inc.
- * In order to receive support of OmniPage SE and PaperPort® 11, you need to upgrade to a Professional version. Please see following URL for upgrade. <http://www.nuance.com/partneroffer/canon>
- Items included in this package are subject to change without notice.
- Keep the package and packing materials for storing or transporting the scanner.

After checking the package contents, you need to prepare the scanner for use. (STEP2)

STEP 2 Removing the Packing Materials and Installing the Rollers

Perform the following steps to remove the scanner from the box, remove the orange tape and protective sheets from the scanner, and install the roller unit and retard roller in the scanner.

1. Peel off all the orange tape from the outer casing.

When peeling off the protective tape fastening the document eject tray extension, hold the document eject tray extension firmly in place with your hand.

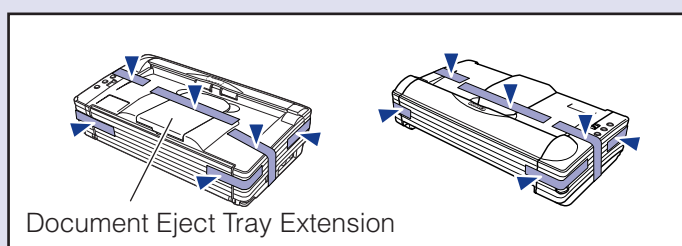

2. Open the rear cover and remove the protective sheet.

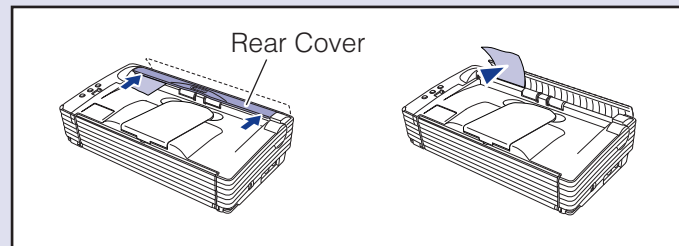

3. After pushing both sides of the rear cover closed, open the document feed tray.

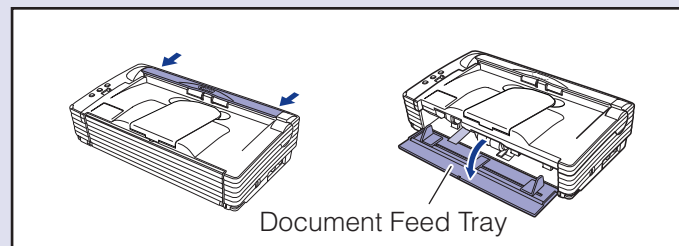

4. While squeezing the OPEN knob from both sides, open the upper unit.

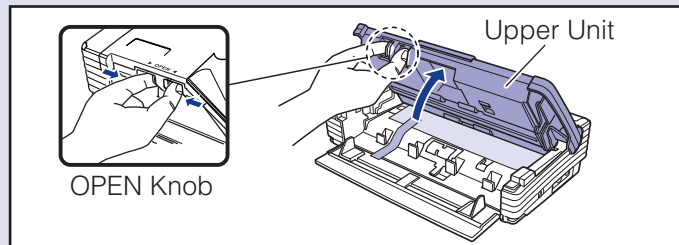

5. Remove the orange protective tape together with the protective sheet.

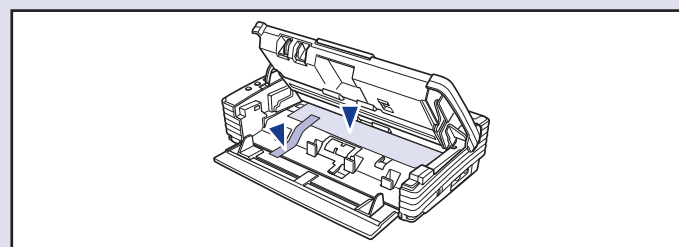

6. Check that all the protective tape and protective sheets have been removed, and then install the roller unit and the retard roller in their designated locations.

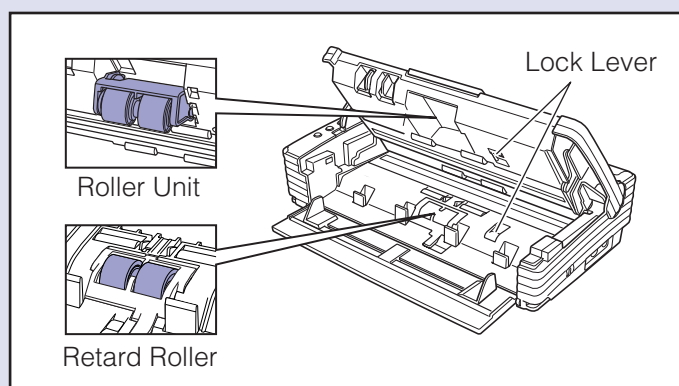

6-1 Follow the steps below to install the roller unit in the upper unit.

1. Flip up the lock lever (1), and slide it to the right (2).

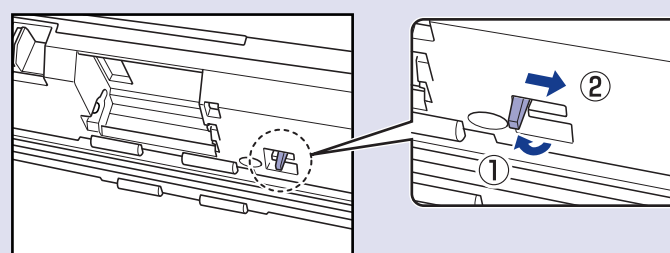

2. Load the roller unit onto the scanner's shaft.

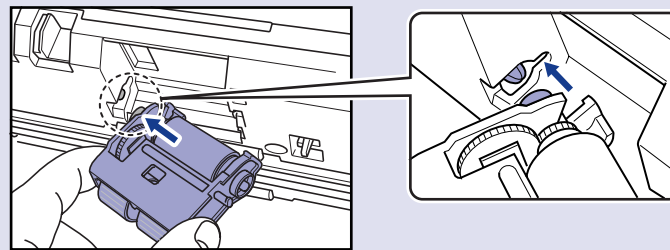

3. Slide the protrusion on the roller unit into the groove on the scanner, and then lift the roller unit into place.

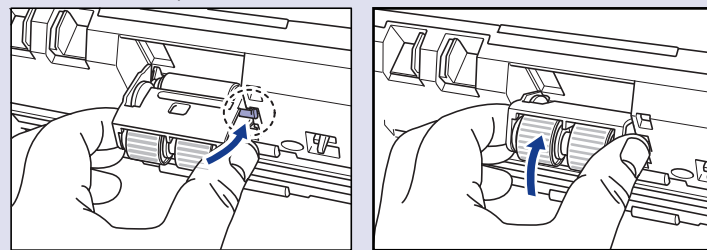

4. Slide (1) and close (2) the lock lever to lock the roller unit.

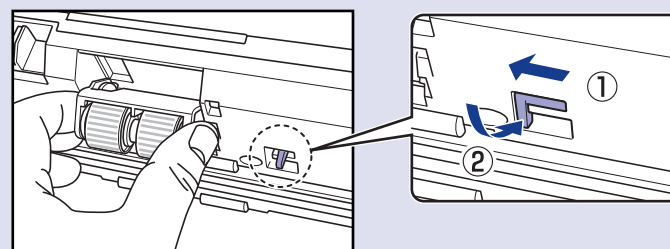

6-2 Follow the steps below to install the retard roller on the inside of the roller cover.

1. Remove the roller cover.

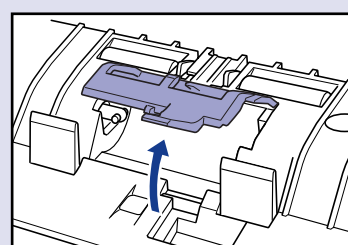

2. Flip up the retard roller lock lever (1), and slide it to the right (2)

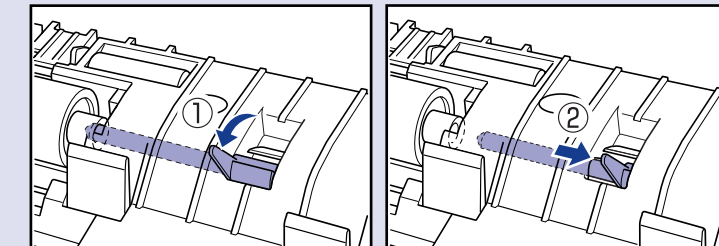

3. Load the retard roller so that the notch in the roller is aligned with the scanner's shaft.

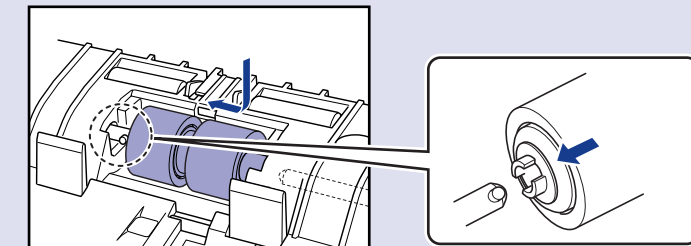

4. Slide the lock lever to the left so that it fits into the retard roller hole (1), and then press the lock lever completely down to lock the retard roller (2).

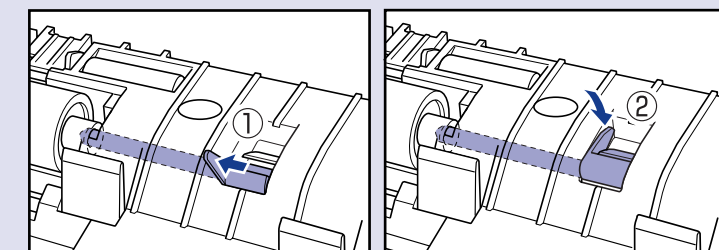

5. Attach the roller cover.

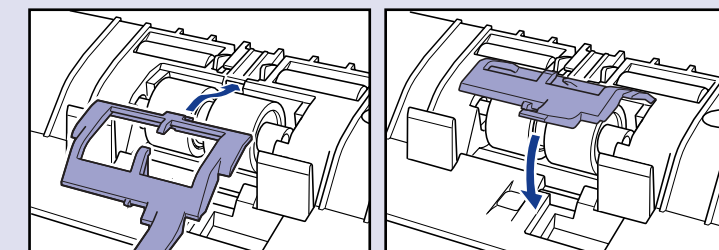

7. Gently close the upper unit.

Make sure it is closed securely by pushing on both edges until you hear a click.

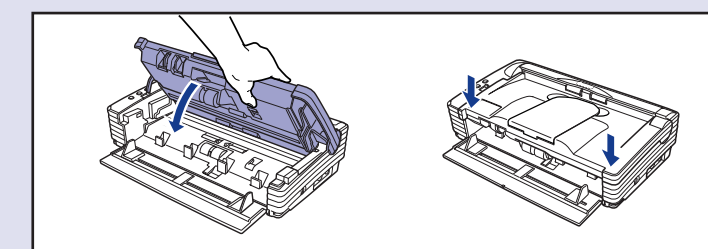

The scanner is now ready for use.

Next, you need to install the scanner software. (STEP3)

STEP 3 Installing the Software

Install the software before connecting the scanner to the computer.

Warning

- Do not connect the scanner to the computer before installing the software. If you connect the scanner and turn it ON before you install the software, the wizard screen on the right will appear. If this wizard is displayed, click the [Cancel] button to exit the wizard, and turn the scanner OFF.

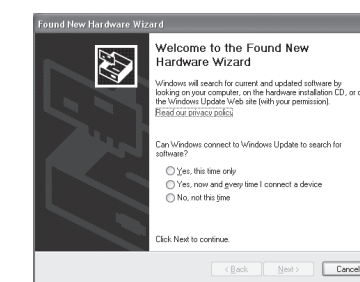

Wizard Screen (Windows XP)

- Be sure to log on with administrator privileges when logging on to Windows.
- Close all other applications before installing the software.

1. Turn ON your computer.

2. Insert the DR-2580C Setup Disc into the computer's CD-ROM drive.

The setup wizard automatically starts up when you insert the CD-ROM into the CD-ROM drive. If the setup wizard does not start up, run the setup.exe application on the CD-ROM.

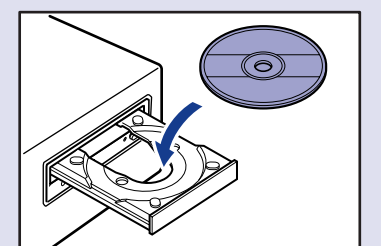

Trademarks

- Canon and the Canon logo are registered trademarks of Canon Inc. in the United States and may also be trademarks or registered trademarks in other countries.
- Microsoft Windows® is a registered trademark of Microsoft USA in the United States and other countries.
- Other brands and product names used in this manual may be trademarks or registered trademarks of their respective companies.

- Click [Typical Installation].
[Typical Installation] installs all of the software. If you want to select which parts of the software to install, click [Custom Installation].



- Click [Install].
All of the currently displayed software is installed. To install only selected software, click [Back] and select [Custom Installation].

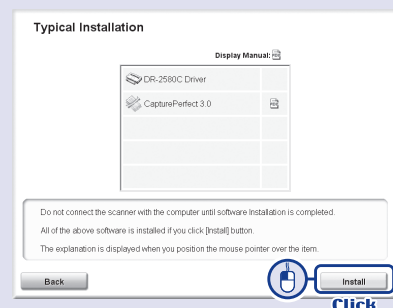

- Click [Next].

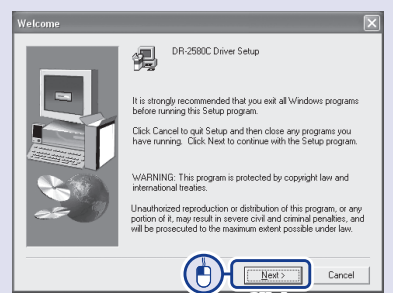

- Read the software license agreement, and click [Yes] if you consent to its conditions.
Installation of the scanner driver starts.

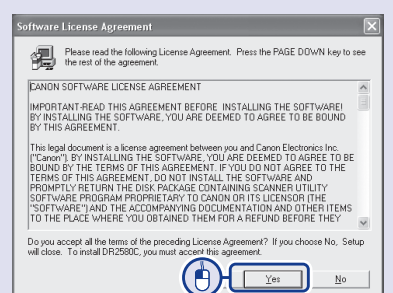

- Click [Finish] to complete the installation.
Next, the installation wizard for CapturePerfect 3.0 appears.

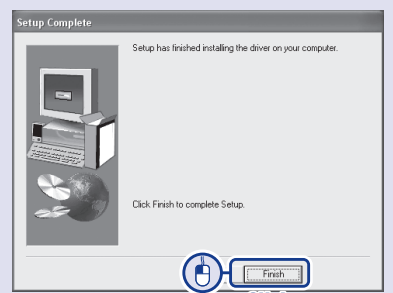

- Click [Next].

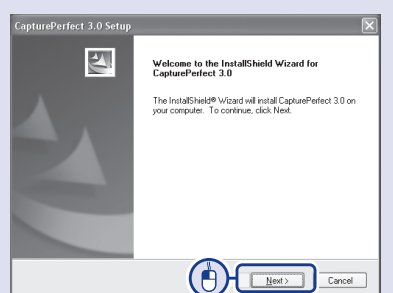

- Read the software license agreement, and click [Yes] if you consent to its conditions.

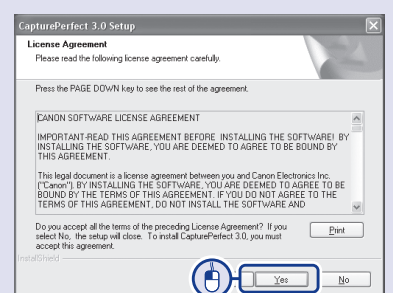

- Check the destination folder for the installation, and click [Next].
Installation of CapturePerfect 3.0 starts.

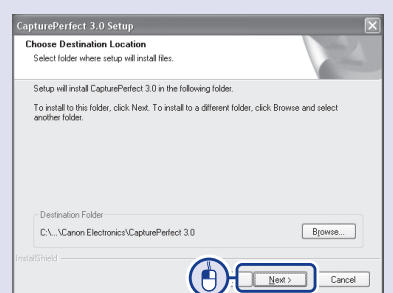

- Click [Finish] to complete the installation of CapturePerfect 3.0.

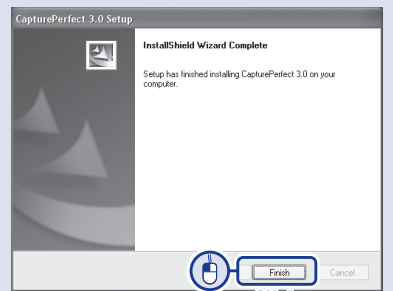

- When all installations are complete, the installation completed screen appears.
Click [Exit] to exit the installer. Click [Back] to return to the menu screen.

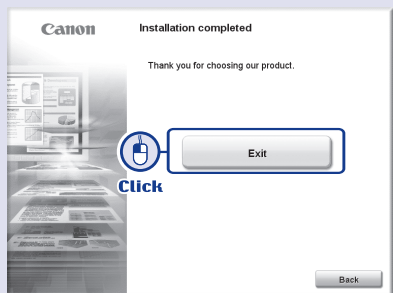

STEP 4 Connecting the Scanner to Your PC

Perform the following steps to connect and register the scanner to your computer.

Warning

- ❑ Use only the power cord and AC adapter included in the package.
- ❑ Connect the scanner to your computer while the scanner is turned OFF.
- ❑ Be sure to log on with administrator privileges when logging on to Windows.

- Connect the power cord to the AC adapter (①).
- Plug the AC adapter into the connector on the left side of the scanner (②).
- Plug the power cord into the power outlet (③).
- Connect the scanner and your PC with the USB cable (④).
- Check the connections, and then press the power switch to turn the scanner ON (⑤).

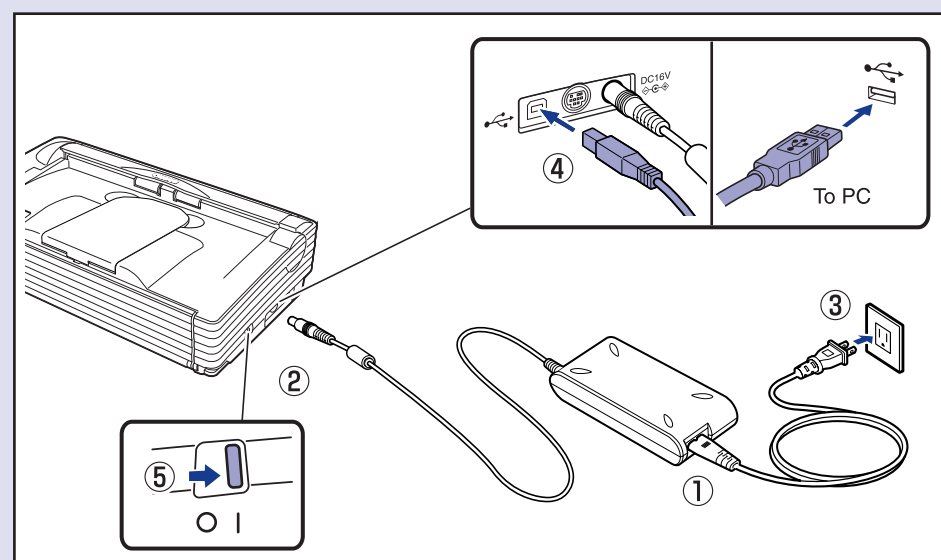

- Windows recognizes the DR-2580C as new hardware and performs installation automatically.

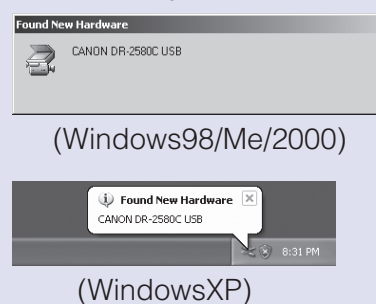

Note

- For Windows XP, a balloon help pop-up appears when installation is finished.
- The installation finished message does not appear in Windows 98/Me/2000.
- The scanner is registered on the computer as "CANON DR-2580C USB" in the "Imaging Devices" directory of the Device Manager.

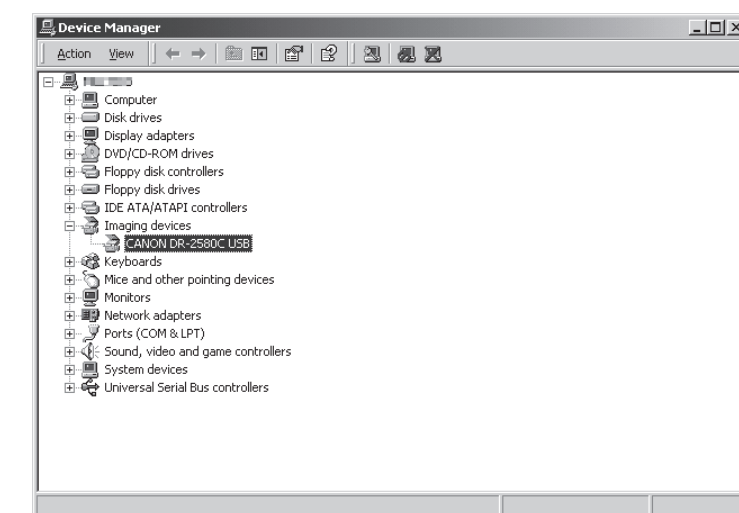

- To open the Device Manager screen, open "System" in the Control Panel, select the "Hardware" tab, and click [Device Manager].
- In Windows XP, "System" appears when the Control Panel is switched to classic view.

The scanner is now correctly recognized by your computer.
In the last step, you can test that documents are scanned properly. (STEP5)

STEP 5 Scanning

When you have finished installing the software and the scanner has been recognized, you can load a document and test that scanning is performed correctly. With the DR-2580C, you can start scanning simply by pressing one of the job buttons on the left side of the scanner. Perform the following steps to load a document and test that it is scanned properly with a job button.

- Open the document feed tray.
- Thoroughly fan the pages of your document, and make sure their edges are aligned.

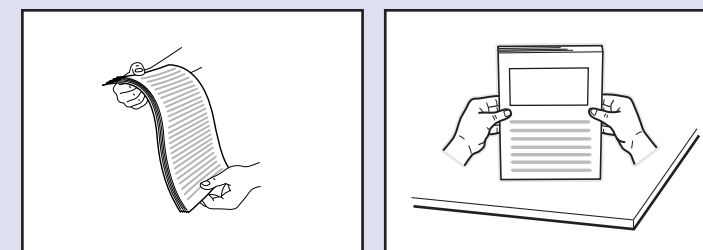

- Load your document in the document feed tray with the printed side facing up, and adjust the document guides to the width of the document.

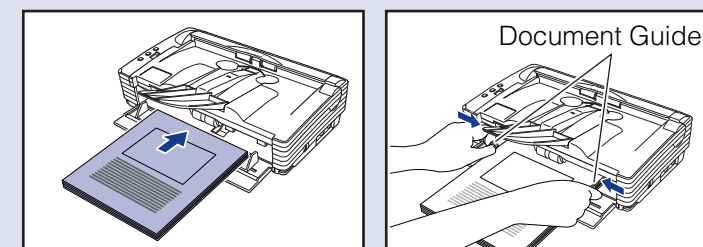

- Make sure the feed selection lever is set to the page separation (≡) side. Be careful not to set the feed selection lever to the bypass (≡) side because this will cause the document pages to feed as a stack, rather than separately. For details on the feed selection lever, refer to the User's Guide.

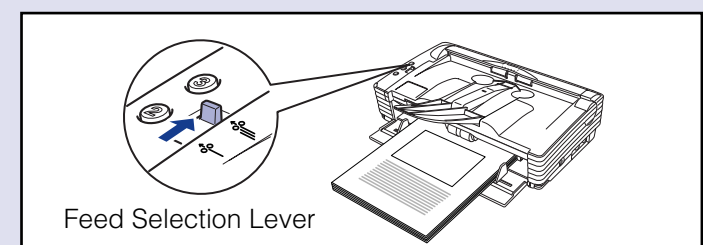

- Make sure the eject selection lever is set to the down (U-Turn Path) position. If the eject selection lever is set to the up (Straight Path) position, document pages are ejected from the rear of the scanner. For details on the eject selection lever, refer to the User's Guide.

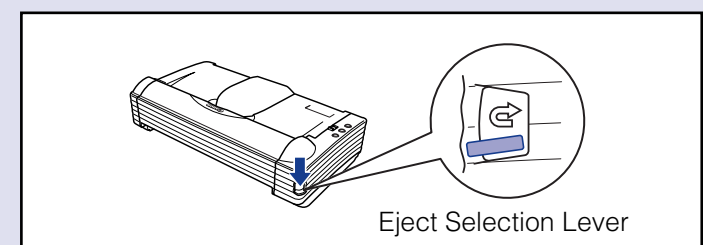

- Press job button 3. The "Monitor for DR-2580C" window appears at the bottom right of the computer screen, and scanning starts.

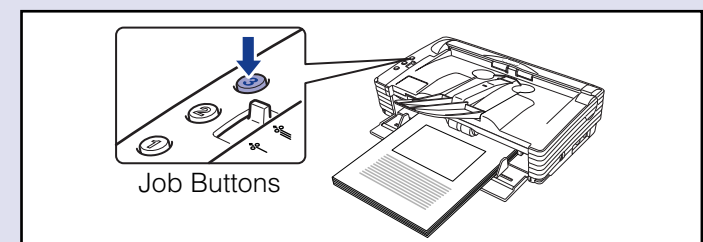

- When "Sending complete" appears in the monitor window, scanning is finished. Click [Close] to close the "Monitor for DR-2580C" window.

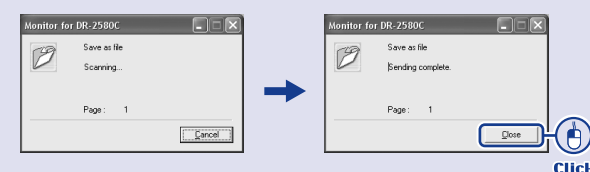

Note

- The following functions are assigned by default to the job buttons.
Job button 1: Scan start
Job button 2: Scan stop
Job button 3: Scan
- The job button functions can be changed. For details on assigning functions to job buttons, refer to the User's Guide.
- Scanned image files are saved in the "My Pictures folder" in "My Documents." (Default)
- By default, scanned image files are saved as PDF files with a 17-digit file name that indicates the date and time when the image was scanned.
- You can change the scan settings and save destination folder by using the "Job Registration Tool" located in the Programs menu of Windows.

The setup is now complete

- This completes the setup of the DR-2580C. Details on how to use the DR-2580C are described in the User's Guide packaged with the scanner. Before you start using the scanner, make sure to thoroughly read the User's Guide.
- For details on how to use "CapturePerfect 3.0", refer to CapturePerfect 3.0 Operation Guide in the Programs menu of Windows.

This completes the software installation.

Next, you need to connect the scanner to your computer. (STEP4)