

Canon



imageFORMULA
DR-2020U

Reference Guide



Please read this manual before using the scanner.
After you finish reading this manual, keep it in a safe place for
future reference.

READ CAREFULLY BEFORE OPENING THE SEALED DISK PACKAGE

CANON SOFTWARE LICENSE AGREEMENT

IMPORTANT-READ THIS AGREEMENT BEFORE OPENING THE SEALED DISK PACKAGE! BY OPENING THE SEALED DISK PACKAGE, YOU ARE DEEMED TO AGREE TO BE BOUND BY THIS AGREEMENT.

This legal document is a license agreement between you and CANON ELECTRONICS INC. ("Canon"). BY OPENING THE SEALED DISK PACKAGE, YOU ARE DEEMED TO AGREE TO BE BOUND BY THE TERMS OF THIS AGREEMENT. IF YOU DO NOT AGREE TO THE TERMS OF THIS AGREEMENT, DO NOT OPEN THE SEALED DISK PACKAGE AND PROMPTLY RETURN THE CANON SCANNER, THE DISK PACKAGE CONTAINING SCANNER DRIVER SOFTWARE PROGRAMS AND/OR SCANNER UTILITY SOFTWARE PROGRAM PROPRIETARY TO CANON OR ITS LICENSOR (THE "SOFTWARE") AND THE ACCOMPANYING DOCUMENTATION AND OTHER ITEMS TO THE PLACE WHERE YOU OBTAINED THEM FOR A REFUND BEFORE THEY ARE USED OR OPENED OR UNPACKED.

In consideration of the right to use the SOFTWARE, you agree to abide by the terms and conditions of this Agreement.

1. GRANT OF LICENSE: Canon grants you the personal, non-exclusive right to use the SOFTWARE only on a single computer. You shall need to obtain multiple licenses separately from Canon when you shall install the SOFTWARE on multiple computers.

You shall not assign, sublicense, sell, rent, lease, loan, convey or transfer to any third party, or send or bring the SOFTWARE out of the country where you originally obtain it to other countries without required authorization of applicable governments, or copy, duplicate, translate or convert to another programming language the SOFTWARE or accompanying documentation, except as expressly provided herein.

Except as expressly permitted under the applicable law, you shall not alter, modify, disassemble, decompile or otherwise reverse engineer the SOFTWARE or accompanying documentation and you also shall not have any third party do so.

2. BACK-UP COPY: You may make one copy of the SOFTWARE solely for a back-up purpose or copy the SOFTWARE onto the permanent storage device (e.g. a hard disk) of your computer and retain the original for a back-up purpose. Except as expressly permitted under the applicable law, any other copying of the SOFTWARE is a violation of this Agreement. You must reproduce and include the copyright notice on the back-up copy.

3. SUPPORT AND UPDATE: Canon, Canon's affiliate, their distributor or dealer is not responsible for maintaining or helping you to use the SOFTWARE. No updates, fixes or support will be made available for the SOFTWARE.

4. LIMITED WARRANTY AND DISCLAIMER OF INDEMNITY: Canon, Canon's affiliate, their distributor or dealer will not guarantee uninterrupted service, or absence or correction of errors. Therefore, the SOFTWARE is licensed on an "AS IS" basis without warranty of any kind. The diskette on which the SOFTWARE is recorded is warranted against defective material or workmanship under normal use for a period of ninety (90) days from the date you purchased the same as evidenced by a receipt or otherwise. The limited warranty does not apply if the failure of the diskette resulted from accident, abuse or misapplication of the SOFTWARE and shall not extend to anyone other than the original user of the SOFTWARE. CANON, CANON'S AFFILIATE, THEIR DISTRIBUTOR OR DEALER DISCLAIMS ALL IMPLIED WARRANTIES, INCLUDING ANY WARRANTY OF MERCHANTABILITY OR FITNESS FOR A PARTICULAR PURPOSE, WITH RESPECT TO THE SOFTWARE OR ACCOMPANYING DOCUMENTATION. NEITHER CANON, CANON'S AFFILIATE, THEIR DISTRIBUTOR NOR DEALER IS LIABLE FOR ANY LOSS OR DAMAGE INCLUDING CONSEQUENTIAL OR INCIDENTAL LOSS OR DAMAGE SUCH AS LOSS OF PROFITS, EXPENSE OR INCONVENIENCE, WHATSOEVER CAUSED BY OR ARISING OUT OF THE SOFTWARE, ACCOMPANYING DOCUMENTATION OR THE USE THEREOF. CANON, CANON'S AFFILIATE, THEIR DISTRIBUTOR OR DEALER SHALL HAVE NO OBLIGATION TO INDEMNIFY YOU AGAINST ANY CLAIM OR SUIT BROUGHT BY A THIRD PARTY ALLEGING THAT THE SOFTWARE, ACCOMPANYING DOCUMENTATION OR THE USE THEREOF INFRINGES ANY INTELLECTUAL PROPERTY OF SUCH THIRD PARTY.

THE ABOVE IS CANON'S ENTIRE LIABILITY AND YOUR EXCLUSIVE REMEDY IN CONNECTION WITH THE SOFTWARE AND ACCOMPANYING DOCUMENTATION.

5. TERM: This Agreement is effective upon opening the sealed disk package and remains in effect until terminated. You may terminate this Agreement by destroying the SOFTWARE and any copy thereof. This Agreement will also terminate if you fail to comply with any of the terms of this Agreement. In addition to Canon enforcing its respective legal rights, you must then promptly destroy the SOFTWARE and any copy thereof.

6. U.S. GOVERNMENT RESTRICTED RIGHTS NOTICE: The SOFTWARE is provided with RESTRICTED RIGHTS. Use, duplication or disclosure is subject to restrictions as set forth in either subparagraph (c) (1) (ii) of the Rights in Technical Data and Computer Software clause at DFARS 252.227-7013 or subparagraph (c) (1) and (2) of the Commercial Computer Software Restricted Rights Clause at FAR 52.227-19, as applicable.

7. SEVERABILITY: In the event that provision of this Agreement is declared or found to be illegal by any court or tribunal of competent jurisdiction, such provision shall be null and void with respect to the jurisdiction of that court or tribunal and all the remaining provisions of this Agreement shall remain in full force and effect.

8. ACKNOWLEDGEMENT: BY OPENING THE SEALED DISK PACKAGE, YOU ACKNOWLEDGE THAT YOU HAVE READ THIS AGREEMENT, UNDERSTOOD IT, AND AGREE TO BE BOUND BY ITS TERMS AND CONDITIONS. YOU ALSO AGREE THAT THIS AGREEMENT IS THE COMPLETE AND EXCLUSIVE STATEMENT OF AGREEMENT BETWEEN YOU AND CANON CONCERNING THE SUBJECT MATTER HEREOF AND SUPERSEDES ALL PROPOSALS OR PRIOR AGREEMENTS, VERBAL OR WRITTEN, AND ANY OTHER COMMUNICATIONS BETWEEN YOU AND CANON RELATING TO THE SUBJECT MATTER HEREOF. NO AMENDMENT TO THIS AGREEMENT SHALL BE EFFECTIVE UNLESS SIGNED BY A DULY AUTHORIZED REPRESENTATIVE OF CANON.

Should you have any questions concerning this Agreement, or if you desire to contact Canon for any reason, please write to Canon's local affiliate.

Setup Guide

Please read first.

STEP 1 Checking the Accessories

If any of the items listed below are missing or damaged, contact your local authorized Canon dealer or service representative.

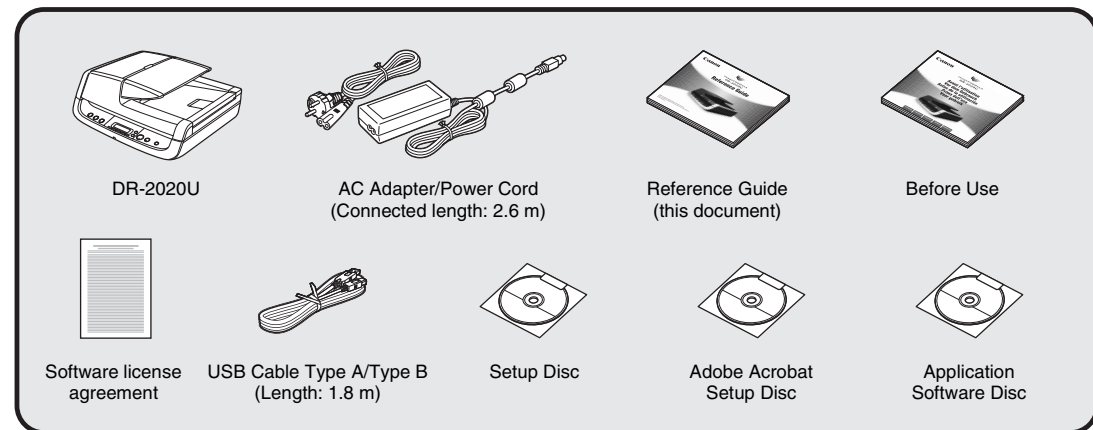

- Items included in this manual are subject to change without notice.
- You must keep the machine's packaging and packing materials for storing or transporting the machine.
- A print version of *Reference Guide* is supplied in English. PDF files of the *Reference Guide* in other languages can be found on the Setup Disc CD-ROM.

STEP 2 Removing the Packing Materials

Remove the scanner from the box, remove the orange tapes (▼) and protective sheets from the scanner, and then release the lock switch.

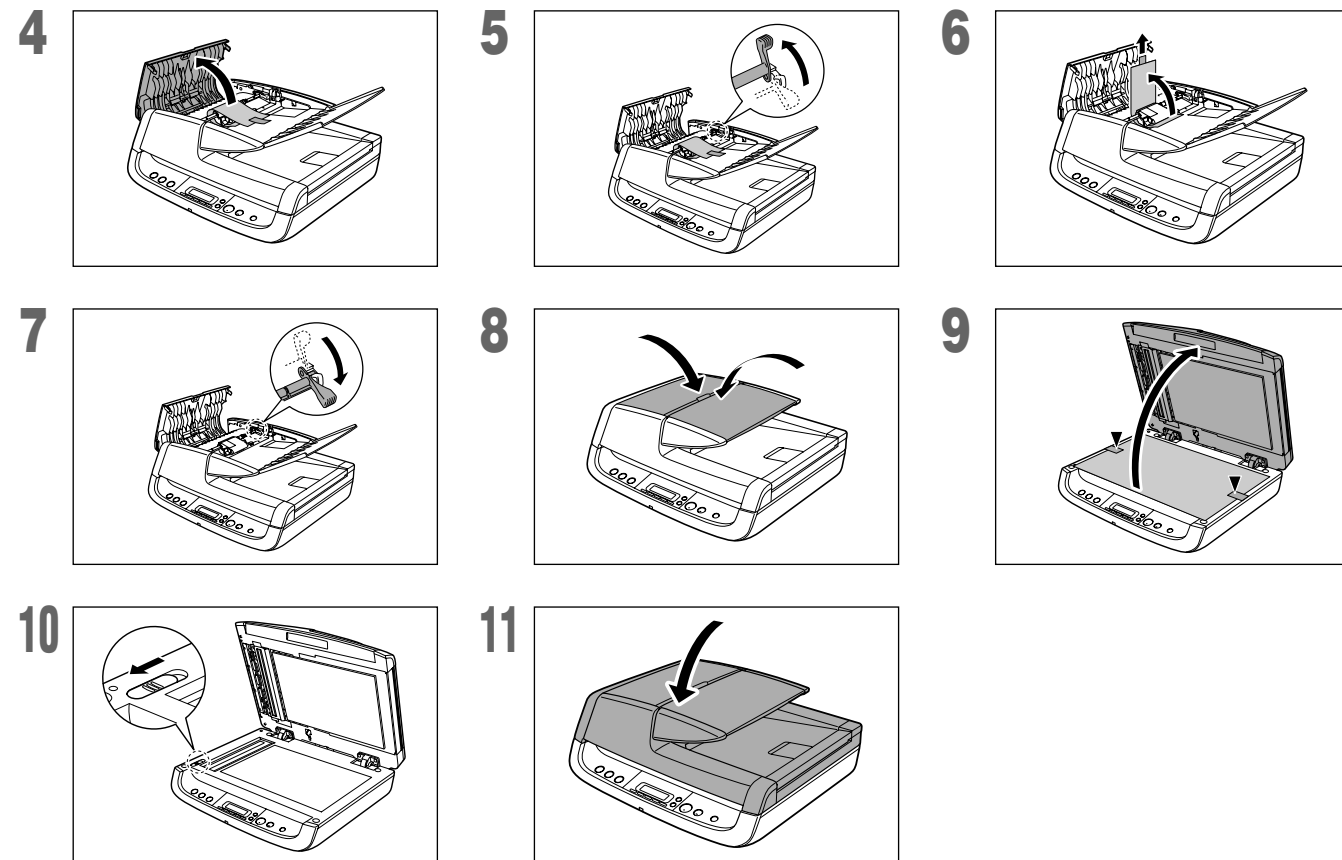
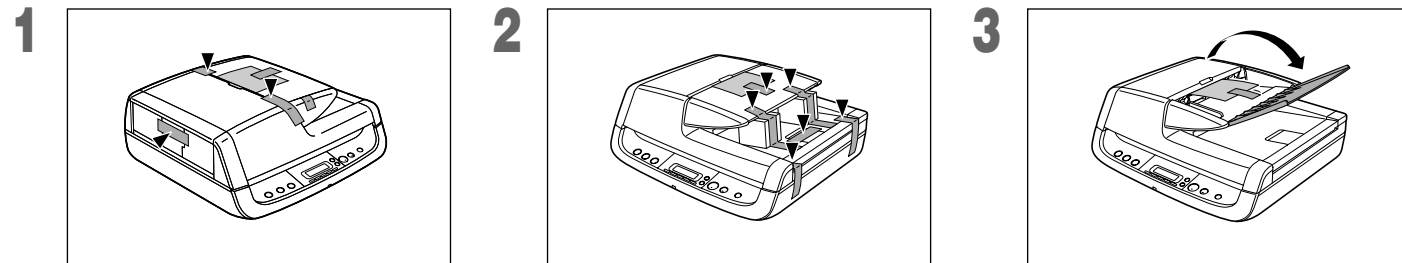

Contents of Application Software CD-ROM

The following applications are included on the supplied Application Software CD-ROM. For details on installation, refer to the Readme.txt file.

- **Presto! BizCard Reader 5 SE**
Business card management software from NewSoft Technology Corp. with multi-language OCR.
- **OmniPage SE 4***
Optical character recognition (OCR) software from Nuance Communications Inc. with multiple language support.

● PaperPort®

File management application from Nuance Communications Inc. that makes it easy to store, organize, and retrieve digital documents.

- In order to receive support of this product, you need to upgrade to a Professional version.
- For details on upgrading, visit the following URL.
<http://www.nuance.com/partneroffer/canon>

➡ Continued on back side

STEP 3 Installing the Software

Before Installation

- Do not connect the scanner to the computer before installing the software.
- Log on to Windows as an Administrator.
- Close all other applications before installing the software.

If you connect the scanner and turn it ON before you install the software, the following wizard screen will appear. If this wizard is displayed, click the [Cancel] button to exit the wizard, and turn the scanner OFF.

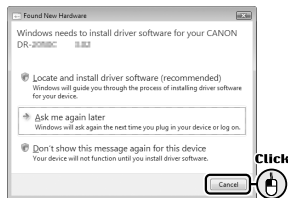

1 Insert the Setup Disc into the computer's CD-ROM drive.

The setup menu automatically starts up when you insert the CD-ROM into the drive. (If the menu does not start up, execute setup.exe from the CD-ROM.)

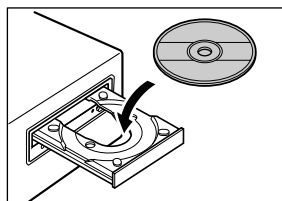

3 Click [Install].



For Windows Vista

If the following screen appears, enter the current administrator password and click [OK].

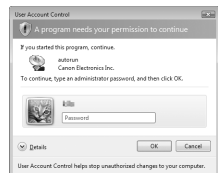

4 Follow the instructions on the screen to complete installation.

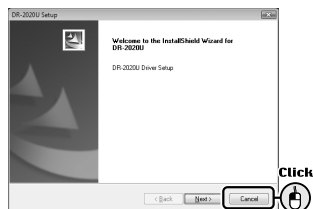

2 Click [Typical Installation].



5 Click [Exit] to close the setup menu.



STEP 4 Connecting to a Computer

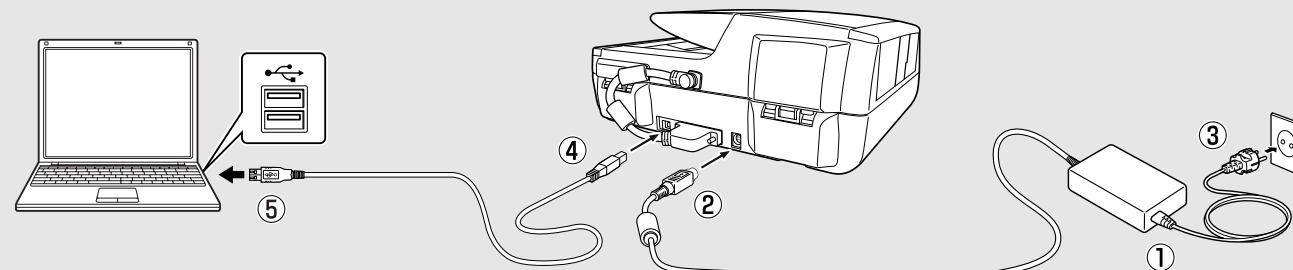

STEP 5 Turning the Scanner ON

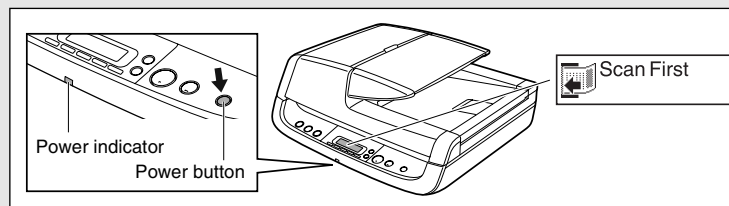

PC Power Link Function

The scanner's power can be linked to the computer, allowing it to be turned ON/OFF in accordance with the computer. When you enable this function and turn ON the computer to which the scanner is connected, the scanner automatically turns ON.

Under default settings, this function is disabled. To enable this function, display the scanner's properties from [Scanners and Cameras] in the Control Panel. For details, refer to the User Manual.

The plug-and-play function recognizes the scanner, and the device driver is automatically installed.



This completes setup.

■ International ENERGY STAR® Office Equipment Program

As an ENERGY STAR® Partner, Canon Electronics Inc. has determined that this machine meets the ENERGY STAR® Program guidelines for energy efficiency.



The International ENERGY STAR® Office Equipment Program is an international program that promotes energy saving through the use of computers and other office equipment.

The program backs the development and dissemination of products with functions that effectively reduce energy consumption. It is an open system in which business proprietors can participate voluntarily. The targeted products are office equipment, such as computers, monitors, printers, fax, machine, copiers, and scanners. The standards and logos are uniform among participating nations.

■ European Union (and EEA) only.



This symbol indicates that this product is not to be disposed of with your household waste, according to the WEEE Directive (2002/96/EC) and your national law.

This product should be handed over to a designated collection point, e.g., on an authorized one-for-one basis when you buy a new similar product or to an authorized collection site for recycling waste electrical and electronic equipment (EEE). Improper handling of this type of waste could have a possible negative impact on the environment and human health due to potentially hazardous substances that are generally associated with EEE. At the same time, your cooperation in the correct disposal of this product will contribute to the effective usage of natural resources. For more information about where you can drop off your waste equipment for recycling, please contact your local city office, waste authority, approved WEEE scheme or your household waste disposal service. For more information regarding return and recycling of WEEE products, please visit www.canon-europe.com/environment. (EEA: Norway, Iceland and Liechtenstein)

■ Für EMVG

Dieses Produkt ist zum Gebrauch im Wohnbereich, Geschäfts- und Gewerbebereich sowie in Kleinbetrieben vorgesehen.

■ Für 3. GPSGV

"Maschinenlärminformations-Verordnung 3. GPSGV: Der höchste Schalldruckpegel beträgt 70 dB(A) oder weniger gemäß EN ISO 7779".

■ Model Names

The following names may be provided for the safety regulations in each sales region of the Document Scanner.

DR-2020U: Model M11071

■ Trademarks

- Canon and the Canon logo are registered trademarks of Canon Inc. in the United States and may also be trademarks or registered trademarks in other countries.
- Microsoft and Windows are registered trademarks of Microsoft Corporation in the United States and other countries.
- ISIS is a trademark of Captiva Software Corporation, in the United States.
- Intel and Pentium are registered trademarks of Intel Corporation.
- ENERGY STAR® is a U.S. registered mark.
- Adobe is the registered trademark of Adobe Systems Incorporated in the United States and/or other countries.
- imageFORMULA is a trademark of CANON ELECTRONICS INC.
- Other product and company names herein may be the trademarks of their respective owners.

■ Copyright

Copyright 2009 by CANON ELECTRONICS INC. All rights reserved.

No part of this publication may be reproduced or transmitted in any form or by any means, electronic or mechanical, including photocopying and recording, or by any information storage or retrieval system without the prior written permission of CANON ELECTRONICS INC.

■ Disclaimers

The information in this document is subject to change without notice.

CANON ELECTRONICS INC. MAKES NO WARRANTY OF ANY KIND WITH REGARD TO THIS MATERIAL, EITHER EXPRESS OR IMPLIED, EXCEPT AS PROVIDED HERE IN, INCLUDING WITHOUT LIMITATION, THERE OF, WARRANTIES AS TO MARKETABILITY, MERCHANTABILITY, FITNESS FOR A PARTICULAR PURPOSE OF USE OR NON-INFRINGEMENT. CANON ELECTRONICS INC. SHALL NOT BE LIABLE FOR ANY DIRECT, INCIDENTAL, OR CONSEQUENTIAL DAMAGES OF ANY NATURE, OR LOSSES OR EXPENSES RESULTING FROM THE USE OF THIS MATERIAL.

CANON ELECTRONICS INC. IS NOT LIABLE FOR THE STORAGE AND HANDLING OF DOCUMENTS SCANNED WITH THIS PRODUCT, OR THE STORAGE AND HANDLING OF THE RESULTING SCANNED IMAGE DATA.

IF YOU INTEND TO DISCARD THE ORIGINALS OF SCANNED DOCUMENTS, YOU ARE RESPONSIBLE FOR INSPECTING THE SCANNED IMAGES AND VERIFYING THAT THE DATA IS INTACT.

THE MAXIMUM LIABILITY OF CANON ELECTRONICS INC. UNDER THIS WARRANTY IS LIMITED TO THE PURCHASE PRICE OF THE PRODUCT COVERED BY THE WARRANTY.

(Hg) LAMP(S) INSIDE THIS PRODUCT CONTAIN MERCURY AND MUST BE RECYCLED OR DISPOSED OF ACCORDING TO LOCAL, STATE OR FEDERAL LAWS.

Table of Contents

Setup Guide	Foldout
Introduction	4
Symbols Used in This Manual.....	4
Manuals for the Scanner.....	4
Important Safety Instructions	5
Installation Location.....	5
Power Supply.....	6
Moving the Scanner.....	7
Handling.....	7
Disposal.....	8
Features of the DR-2020U Document Scanner	9
Names and Functions of Parts	10
Feeding Methods	13
Placing Documents	15
Placing Documents into the Feeder.....	15
Placing Documents on the Flatbed.....	15
Placing Cards into the Business Card Feeder.....	16
Supplied Software	17
Scanning with CaptureOnTouch	18
What is CaptureOnTouch?.....	18
Starting CaptureOnTouch.....	19
Scan First.....	20
Select Scan Job.....	24
Troubleshooting	28
Common Problems and Solutions.....	28
Clearing a Paper Jam.....	30
Appendix	32
Cleaning the Roller Unit and Separation Pad.....	32
Specifications.....	34
Replacement Parts.....	35

Introduction

Thank you for purchasing the Canon Document Scanner imageFORMULA DR-2020U. Please read this manual thoroughly before using the scanner to familiarize yourself with its capabilities, and to make the most of its many functions. After reading this manual, store it in a safe place for future reference.

Symbols Used in This Manual

The following symbols are used in this manual to explain procedures, restrictions, handling precautions, and instructions that should be observed for safety.

WARNING

Indicates a warning concerning operations that may lead to death or injury to persons if not performed correctly. To use the scanner safely, always pay attention to these warnings.

CAUTION

Indicates a caution concerning operations that may lead to injury to persons, or damage to property if not performed correctly. To use the scanner safely, always pay attention to these cautions.

IMPORTANT

Indicates operational requirements and restrictions. Be sure to read these items carefully to operate the scanner correctly, and avoid damaging the scanner.

Hint

Indicates a clarification of an operation, or contains additional explanations for a procedure. Reading these notes is highly recommended.

Manuals for the Scanner

Documentation for this scanner consists of the following manuals. Please read these manuals thoroughly before using the scanner to familiarize yourself with its capabilities and make the most of its many functions.

- **Reference Guide (this manual)**
This describes setup procedures and basic operations for the scanner.
- **User Manual (electronic manual)**
This provides complete and comprehensive information about the scanner.
- **CapturePerfect 3.0 Operation Guide (electronic manual)**
This is the operation guide for the Canon document scanner application, CapturePerfect 3.0.

Hint

Electronic manuals are installed to the following locations as PDF (Portable Documents Format) files during installation of the supplied software.

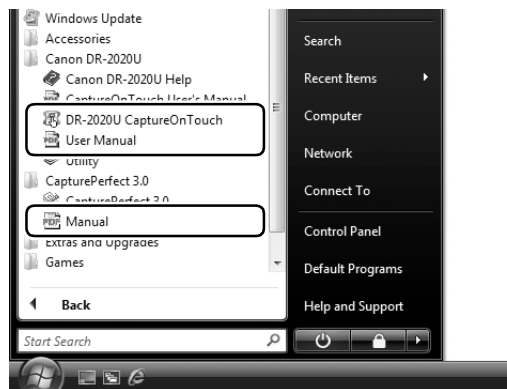

Important Safety Instructions

To ensure the safe operation of this scanner, be sure to read the safety warnings and precautions described below.

Installation Location

The performance of this scanner is affected by the environment in which it is installed. Make sure that the location where the scanner is installed meets the following environmental requirements.

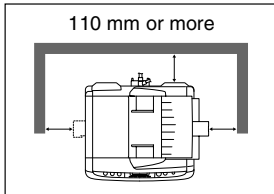

- Provide adequate space around the scanner for operation, maintenance, and ventilation.

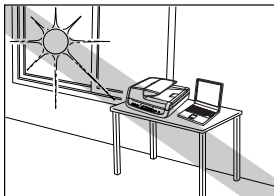

- Avoid installing the scanner in direct sunlight. If this is unavoidable, use curtains to shade the scanner.

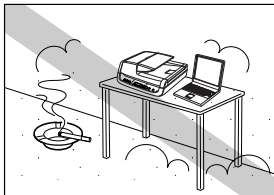

- Avoid locations with excessive dust.

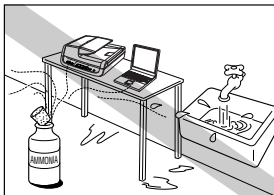

- Avoid warm or humid locations, such as in the vicinity of a water faucet, water heater, or humidifier, and avoid locations where the fumes from ammonia, paint thinner, or other volatile chemicals may be present.

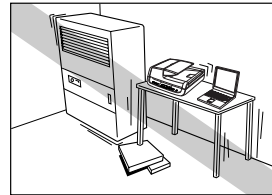

- Avoid locations that are unstable or subject to vibration.

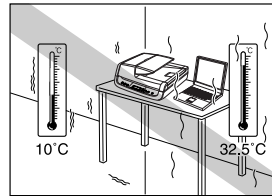

- Avoid exposing the scanner to rapid changes in temperature. If the room in which the scanner is installed is cold but rapidly heated, water droplets (condensation) may form inside the scanner. This may result in a noticeable degradation in scanning quality. The following conditions are recommended for optimal scanning quality:
Room temperature: 10°C to 32.5°C
Humidity: 20% to 80% RH

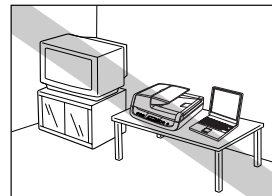

- Avoid installing the scanner near equipment that generates a magnetic field (e.g., speakers, televisions, or radios).

Power Supply

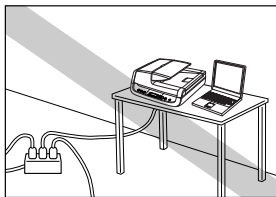

- Connect only to a power outlet of the rated voltage and power supply frequency (either 120 V, 60 Hz or 220-240 V, 50/60 Hz, depending on your region).
- Do not connect other electrical equipment to the same power outlet to which the scanner is connected. Also, when using an extension cord, make sure that the extension cord is rated for the current requirements of the scanner.

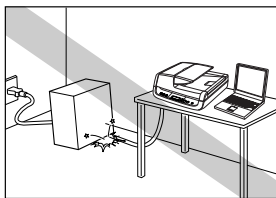

- Never attempt to dismantle or modify the AC adapter in any way, as doing so is dangerous.
- Do not place objects on or step on the AC adapter or power cord.

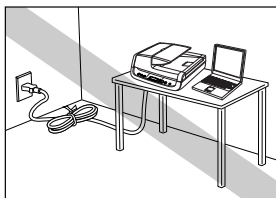

- Do not use the power cord while it is coiled.

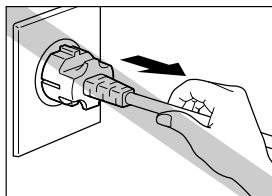

- Do not pull directly on the power cord. When disconnecting the power cord, grasp the power plug and remove it from the power outlet.
- Keep the area around the power plug clear of objects so that the power cord can be disconnected easily in an emergency.
- Use only the AC adapter supplied with the scanner. In addition, do not use the supplied AC adapter with devices other than the scanner.
- If you have any questions regarding the power supply, contact your local authorized Canon dealer or service representative for further information.

Moving the Scanner

- Before moving the scanner, make sure to turn the power switch OFF, and disconnect the power plug from the power outlet.
- When moving the scanner, make sure to lock the lock switch and carry the scanner with both hands so as not to drop it. The scanner weighs approximately 7.8 kg.

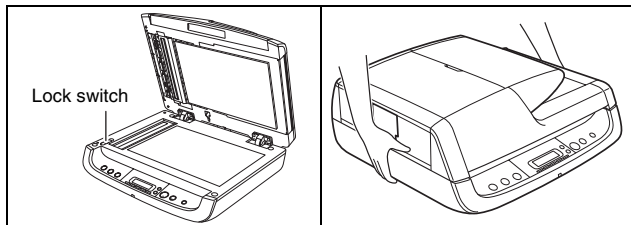

- When using the scanner, make sure to release the lock switch. If you use the scanner while the lock switch is locked, an error will appear on the display panel.
- Make sure to disconnect any interface cables and the AC adapter when moving the scanner. If the scanner is carried with these items connected, the plugs and connectors may be damaged or cause the scanner to fall and result in personal injury or damage to the scanner.

Handling

WARNING

Note the following precautions whenever using the scanner. Failure to do so may result in a fire or electric shock.

- Never place alcohol, benzene, paint thinner, aerosol sprays, or any other flammable substances near the scanner.
- Do not cut, damage, or modify the power cord. Do not place heavy objects on the power cord, and do not pull or excessively bend the power cord.
- Never connect the power cord when your hands are wet.
- Do not connect the scanner to a multiplug power strip.
- Do not knot or coil the power cord, as this may result in a fire or electric shock. When connecting the power cord, make sure that the power plug is securely and completely inserted into the power outlet.

- To use a reel-type extension cord, unwind all of the cord from the reel. Long-term operation with the cord wound on the reel may cause the cord to overheat and may cause a fire.
- Do not use power cords or AC adapters other than the power cord and AC adapter provided with this scanner.
- Do not attempt to dismantle the scanner or modify it in any way, as this is dangerous and may lead to a fire or electric shock.
- Never attempt to dismantle or modify the AC adapter in any way, as doing so is dangerous.
- Do not use flammable aerosol spray products near the scanner.
- When cleaning the scanner, turn the power switch OFF and disconnect the power cord from the power supply.
- Clean the scanner using a slightly dampened cloth that has been well wrung out. Never use alcohol, benzene, paint thinner, or any other flammable substance.
- Disconnect the power cord from the power outlet regularly, and clean the area around the base of the power plug's metal pins and the power outlet with a dry cloth to ensure that all dust and grime is removed. If the power cord is connected for a long period of time in a damp, dusty, or smoky location, dust can build up around the power plug and become damp. This may cause a short circuit and result in a fire.
- If the scanner makes strange noises, or gives off smoke, heat or strange odors, or the scanner does not function or other abnormalities occur when you use the scanner, immediately turn the power switch OFF and disconnect the power plug from the power outlet. Then, contact your local authorized Canon dealer or service representative for further information.
- Do not drop the scanner, or subject it to impact or strong shock. Should the scanner ever become damaged, immediately turn the power switch OFF, and disconnect the power plug from the power outlet. Then, contact your local authorized Canon dealer or service representative to have the unit serviced.
- Notice to Cardiac Pacemaker Users:
This product generates a weak magnetic field. If you use a cardiac pacemaker, move away from the product in the event that you notice any unusual symptoms. Also, please consult a cardiologist.

CAUTION

- Do not install the scanner on a surface that is unstable, tilted, or in an area subject to excessive vibrations, as this may cause the scanner to fall, resulting in personal injury or damage to the scanner.
 - Do not block the ventilation openings. Doing so may cause the scanner to overheat, creating a risk of fire.
 - Never place small metal objects, such as staples, paper clips, or jewelry on the scanner. These items may fall into the scanner, and cause a fire or electric shock. If such objects ever fall inside the scanner, immediately turn the power switch OFF, and disconnect the power plug from the power outlet. Then, contact your local authorized Canon dealer or service representative to have the unit serviced.
 - Do not locate the scanner in a humid or dusty location. Doing so may cause a fire or electric shock.
 - Do not place objects on top of the scanner. Such objects may tip or fall over, resulting in personal injury.
 - Do not use the scanner with a power supply voltage other than 100 VAC. Doing so may result in a fire or electric shock.
 - When unplugging the power cord, grasp it firmly by its plug. Do not pull directly on the power cord, as this may damage or expose the cord's internal wiring, resulting in a fire or electric shock.
 - Leave sufficient space around the power plug so that it can be unplugged easily. If objects are placed around the power plug, you will be unable to unplug it in an emergency.
 - Do not allow water or flammable substances (alcohol, benzene, paint thinner, etc.) to spill into the scanner, as this may result in a fire or electric shock.
 - Turn OFF the power switch for safety when not using the scanner for a long period of time, such as overnight. Also, turn OFF the power switch, and disconnect the AC adapter from the scanner and disconnect the power cord from the power outlet for safety when the machine will not be used for an extended period of time, such as during consecutive holidays.
 - Do not wear loose clothing or jewelry that may get caught in the scanner while you are using it. This may result in personal injury. Be extra careful of neckties and long hair. If anything becomes caught in the scanner, immediately disconnect the power cord to stop the scanner.
- Be careful when placing paper in the scanner and when removing jammed paper. It is possible to cut your hand on the edge of a sheet of paper.
 - Open and close the feeder carefully and slowly. Failure to do so may result in malfunction or personal injury.
 - Take care to avoid pinching your hands when closing the feeder. Failure to do so may result in personal injury.
 - Do not press down hard on the feeder. Doing so may result in damage to the glass, malfunction, or personal injury.
 - Never place any object other than documents to be scanned onto the feeder's feed and eject areas. Doing so may result in malfunction or personal injury.
 - When using the scanner in cold temperatures, wait a few moments after turning the power switch ON. Failure to do so may result in a condensation error.

Disposal

When disposing of the scanner and AC adapter, make sure to follow the local ordinances and laws or consult with your local authorized Canon dealer.

Features of the DR-2020U Document Scanner

The main features of the DR-2020U document scanner are described below.

● Multiple Methods for Documents Feeding

Depending on the type of document you intend to scan, you can use the feeder, flatbed, or business card feeder.

● Fast Document Feeding

Scan multipage documents at up to 20 pages per minute (for single-sided documents) using the built-in feeder. The scanner can detect documents that are loaded into the feeder and begin scanning automatically using the auto-start function.

● Flatbed

Use the flatbed to scan documents that cannot be scanned through the feeder (thin documents, documents that do not feed smoothly, magazines and thicker documents, etc.).

● High Image Quality

The 600 dpi optical resolution sensor incorporated in the scanner enables documents to be scanned with high image quality.

● PC Power Link Function

The power of the scanner can be linked to be automatically turned ON/OFF in accordance with the power of the computer.

● Color/Grayscale Support

Documents can be scanned in 24-bit color or 256-level grayscale.

● Supports a Variety of Scanning Modes

The scanner supports the following scanning modes, depending on the document type.

- Simplex and Duplex scanning (with Skip Blank Page function)
- Continuous or single-page feeding

● Card Scan

Feed and scan up to 15 business cards at a time using the built-in business card feeder.

● Paper Size Detection

The scanner automatically detects the size of a scanned document and eliminates any unnecessary space around the edges of the image when storing the image, even when storing a document of irregular size.

● Auto Color Detection

The scanner detects whether the scanned document is in color or black and white, and saves the image accordingly.

● Deskew

The scanner straightens scanned images when it detects that the document was placed askew.

● Text Enhancement Modes

The scanner is equipped with the Advanced Text Enhancement Mode, for enhancing the text of documents with dark or uneven backgrounds, and the Advanced Text Enhancement II mode, for enhancing the text when both the text and background are light.

* These modes may not work, depending on the type of document.

● Color Drop-out

The scanner is equipped with a Color Drop-out function that enables you to specify a color for the scanner to omit from the scanned image.

● Skip Blank Page Function

The scanner is equipped with a Skip Blank Page function that enables you to scan a document without storing images of blank pages, regardless of whether each page of the document is two-sided or one-sided. During duplex scanning, page images are not saved for sides detected to be blank.

● Prescan Function

The scanner is equipped with a Prescan function that allows you to adjust the contrast and brightness of a prescanned image and then send the adjusted image to the application software, without needing to scan the document again.

● Job Function

The scanner includes three job buttons for automatically scanning and performing operations (up to ten operations, such as saving, printing, or mailing, can be registered) on the scanned image.

● Scan First

Press the Job Start button to start CaptureOnTouch, which provides simple scanning by following on-screen instructions.



Hint

Some functions may not be available depending on the software you are using.

Names and Functions of Parts

Front

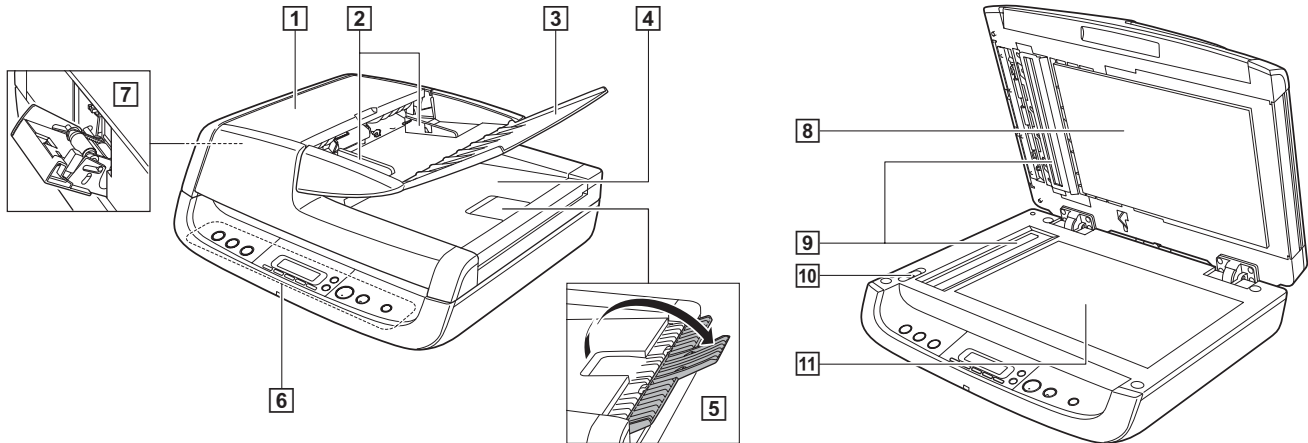

1 Feeder Cover

Open this to clear paper jams or to perform cleaning.

2 Document Guides

Adjust this to the width of the document.

3 Document Feed Tray

Open this when placing documents into the feeder.

4 Document Eject Tray

Documents scanned through the feeder are ejected here.

5 Eject Tray Extension

Open this if documents scanned through the feeder hang over the edge of the eject tray.

6 Operation Panel

Buttons for operating the scanner and an LCD are located here. (See p. 11.)

7 Business Card Feeder

Open and use this when scanning business cards.

8 Pressure Board

This presses documents placed on the flatbed against the glass.

9 Scanning Glass (Feeder)

10 Lock Switch

Use this to lock the inner parts of the scanner into place when not using the scanner.

11 Scanning Glass (Flatbed)

Place documents here with their scanning sides facing down.

Operation Panel

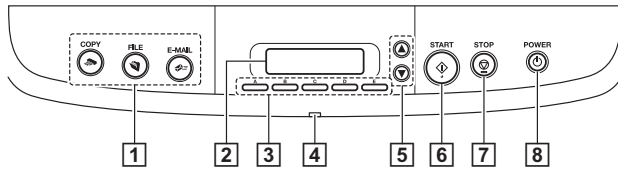

1 Job Buttons

Specific jobs are assigned to these buttons. Scanning will start when any of these buttons are pressed. The scanned images will be processed as follows for each button:

COPY: Prints scanned images to a specified printer.

FILE: Saves scanned images in a specified folder.

E-MAIL: Sends a new e-mail message with scanned images.

2 Display Panel

The scanner status and error messages are displayed here. Job names configured with the supplied software also appear here. (See p. 11.)

3 User Defined Job Buttons

Register jobs with the supplied software and assign them to these buttons.

4 Power Indicator

This lights when the scanner is turned ON.

5 Scroll Keys

These buttons allow you to scroll the display panel when selecting registered jobs.

6 START Button

This button performs the following functions.

- Executes jobs selected with the user defined job buttons or scroll keys.
- Starts scanning when an application is used and the [Feeding Option] is set to [Panel-Feeding].
- Launches the application configured with the Windows Events function.

7 STOP Button

Press this button to stop scan procedures or clear error displays, such as those for paper jams.









8 POWER Button

Press this button to turn the scanner ON, and the power indicator will light.

When you press and hold this button (for 2 seconds) while the scanner is turned ON, the scanner and power indicator will turn OFF.

Display Panel Indications

Normal Displays

 Scan First	Scan First (waiting for documents to be placed).
 Ready	Ready (awaiting operations via buttons or computer).
1.My Document	Job display.
 COPY	Job display when the COPY button is pressed.
 FILE	Job display when the FILE button is pressed.
 E-MAIL	Job display when the E-MAIL button is pressed.
 Scanning...	Scanning in progress.
 Waiting...	Waiting for operation (such as when a document runs out, etc.).
 Ready (CARD)	The business card feeder is open (waiting for cards to be placed).

Error Displays



Communication error with computer.



When an error occurs, a message indicating the nature of the error appears. You can use the scroll keys to scroll longer messages. For details on the error messages and their solutions, see page 29.

Rear

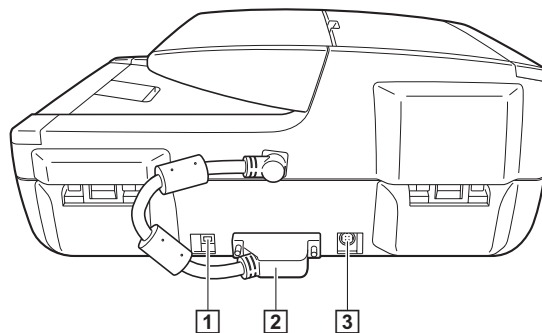

1 USB Connector

Connect the supplied USB cable (or Hi-Speed USB 2.0 compatible cable) here.

2 ADF Connector



CAUTION



Never disconnect the ADF connector. The feeder will stop functioning if the ADF connector is disconnected.

3 Power Connector

Connect the supplied AC adapter here.

Feeding Methods

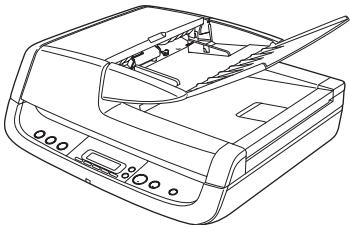
There are three feeding methods (feeder, flatbed, business card feeder) for scanning documents with this scanner. The types of documents that can be scanned with each method are as follows.

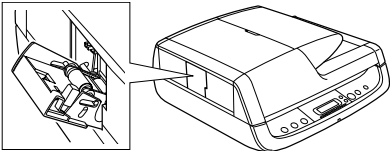
Feeder (See p. 15.)	Flatbed (Platen Glass) (See p. 15.)	Business Card Feeder (See p. 16.)
		
<p>Width: 140 mm to 216 mm Length: 100 mm to 356 mm Thickness: 52 to 128 g/m² (0.06 mm to 0.15 mm) Capacity: Up to 50 sheets or a stack height of 5.0 mm</p>	<p>Width: 216 mm Length: 297 mm Thickness: Up to 25 mm</p>	<p>Width: 49 mm to 55 mm Length: 85 mm to 91 mm Thickness: 128 to 300 g/m² (0.15 mm to 0.3 mm) Capacity: Up to 15 cards or a stack height of 3.8 mm</p>

Precautions for Using the Feeder

- When scanning a multipage document in a single scan procedure using the feeder, make sure that all of the pages are identical in thickness, and quality of paper. Feeding different types of paper at one time may cause a paper jam.
- Scanning documents before the ink is dry will make the rollers and scanning glass dirty, resulting in smears on the scanned image and other documents becoming dirty. Always make sure that the ink on a document is dry before scanning it.
- Scanning documents that are written in pencil or similar material will make the rollers and scanning glass dirty, resulting in smears on the scanned image.

- When scanning thin paper, text or images on the reverse side of the page may bleed through onto the scanned image. In this case, adjust the brightness under the scanning conditions.
- Always make sure to check that paper clips, staples, and similar objects are not mixed in with a document before loading it into the feeder. The presence of such objects may result in damage to documents, paper jams, and damage to the scanner.
- Do not wear loose clothing or jewelry that may get caught in the scanner while you are using it. Doing so may result in personal injury. Be extra careful of neckties and long hair. If anything becomes caught in the scanner, immediately disconnect the power plug from the power outlet to stop the scanner.

- Documents with curled edges may result in folds and paper jams. Make sure to straighten out the curls before loading documents in the scanner.
- Handle paper edges with care, and be careful not to cut your fingers when loading documents.

Documents That Cannot Be Scanned with the Feeder

Use the flatbed (platen glass) to scan the following types of documents. Using the feeder may result in paper jams and damage to the scanner.



Wrinkled or creased paper



Carbon-backed paper



Curled paper



Coated paper



Torn paper



Extremely thin paper



Paper with clips or staples

Placing Documents

Placing Documents into the Feeder

- 1 Fan the pages of the document to be scanned, and load the document into the feeder with the scanning side facing up.

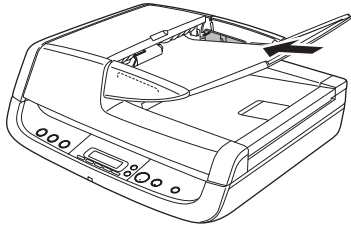

- 2 Adjust the document guides to the edges of the document.

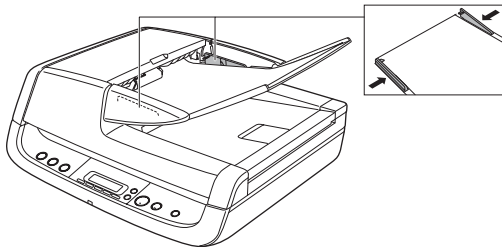

! IMPORTANT

- Close the business card feeder. The documents placed into the feeder cannot be scanned if the business card feeder is open.
- Scanning curled or creased documents may result in damage to the documents.
- Even if a document does not exceed the document feed tray's capacity (see p. 13), pages may not feed properly depending on the document type. In this case, decrease the number of pages in the document feed tray.
- Open the eject tray extension if you are scanning documents that are longer than the eject tray.

Placing Documents on the Flatbed

- 1 Place the document on the flatbed with the scanning side facing down, and align the upper left corner of the document with the positioning guide on the flatbed.

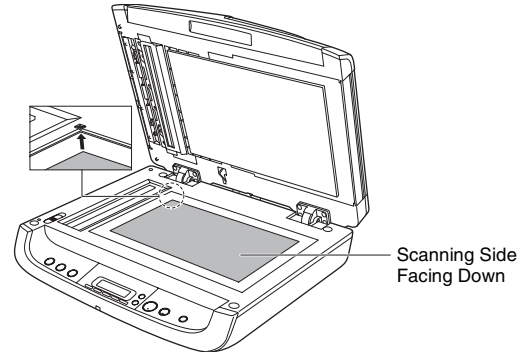

! IMPORTANT

- Do not place objects other than the document to be scanned onto the flatbed platen glass. Doing so may result in damage or personal injury.
- Open and close the feeder gently. Excessive force may result in damage to the feeder or breaking the scanning glass and personal injury.

When the Scanner Is in Sleep Mode

When the scanner is not operated for a specific amount of time, it automatically enters the sleep mode. The scanner automatically exits the sleep mode if you initiate scanning from a computer. However, to initiate scanning from the scanner's operation panel, you must exit the sleep mode manually.

To exit the sleep mode manually, press the POWER button on the operation panel. The scanner exits the sleep mode.

Placing Cards into the Business Card Feeder

1 Open the business card feeder.

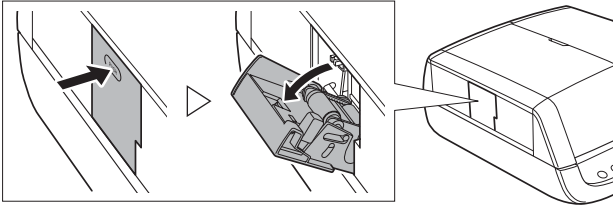

2 Hold down the lever (①) on the side of the business card feeder, and place the cards into the feeder with the scanning side facing up. Fully insert the cards until they reach the stoppers (②) at the back of the feeder.

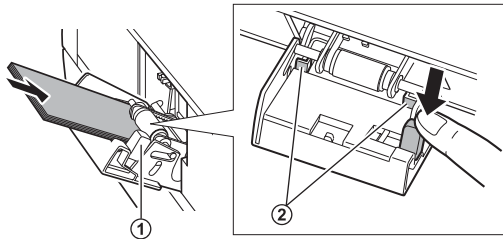

3 Close the business card feeder when scanning is finished.

⚠ IMPORTANT

- When the business card feeder is open, only the Business Card and Auto-detection options are available for the paper type configuration under the driver settings. In addition, documents loaded into the feeder cannot be scanned.
- Open and close the business card feeder gently. Excessive force may result in damage to the business card feeder.
- Precautions for using the business card feeder are the same as those for the feeder. (See p. 13.)
- Close the business card feeder when it is not in use.

- Business cards are ejected in reverse order after scanning from the business card feeder.
- Scan plastic cards on the flatbed.

When the Scanner Is in Sleep Mode

When the scanner is not operated for a specific amount of time, it automatically enters the sleep mode. The scanner automatically exits the sleep mode if you initiate scanning from a computer. However, to initiate scanning from the scanner's operation panel, you must exit the sleep mode manually.

To exit the sleep mode manually, press the POWER button on the operation panel. The scanner exits the sleep mode.

Supplied Software

Use the following software supplied with the scanner to scan documents. Select which software to use based on your intended purpose.

Use this when you want to start scanning merely by pressing a button on the scanner.
Easily scan without computer operations.

CaptureOnTouch

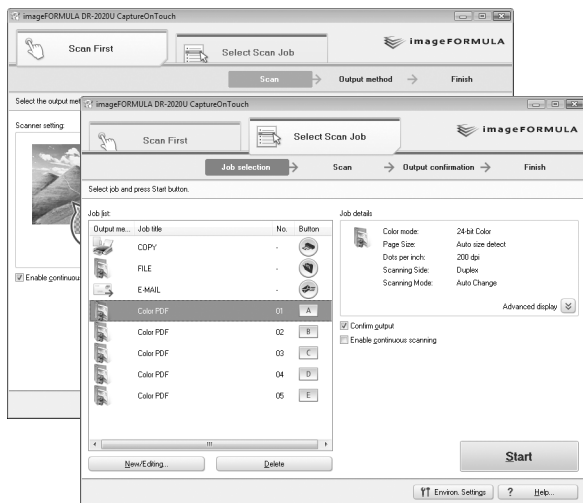

This scanning application, designed specifically for use with this scanner, allows you to scan using easy-to-follow on-screen instructions.

For details on operation, see page 18.



Hint

ISIS/TWAIN drivers are installed with the above software when installing from the setup disc. Scanning is available from both ISIS and TWAIN applications when the ISIS/TWAIN drivers are installed. Refer to the *User Manual* (electronic version) for details about the ISIS/TWAIN drivers.

Specify advanced scanning conditions, and process scanned images (rotate images, change the order of pages, etc.)

CapturePerfect 3.0



This scanning application designed for advanced users includes a variety of scanning methods and processing functions for scanned images.

For details on operation, refer to the *CapturePerfect 3.0 Operation Guide* (electronic manual).

Scanning with CaptureOnTouch

What is CaptureOnTouch?

CaptureOnTouch is a scanning application that allows you to scan documents using easy-to-follow on-screen instructions.

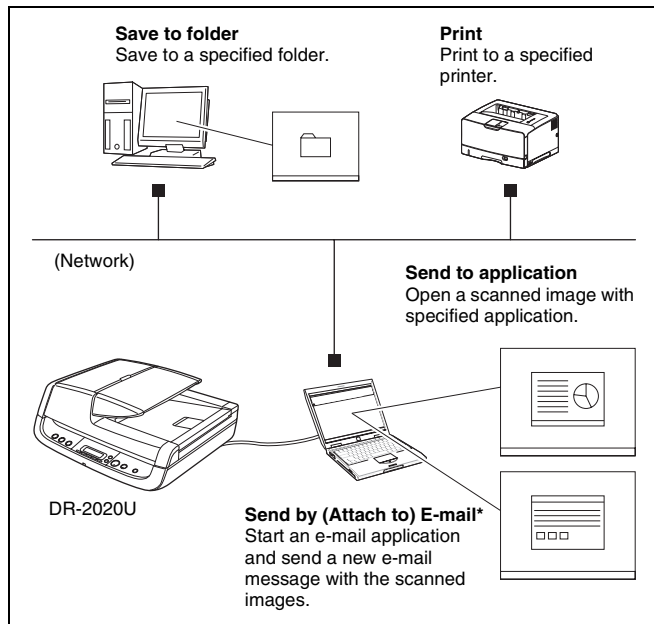

* [Attach to E-mail] in [Scan First], and [Send by E-mail] in [Select Scan Job].

CaptureOnTouch provides multiple scanning methods for you to select based on your intended purpose.

Scan First

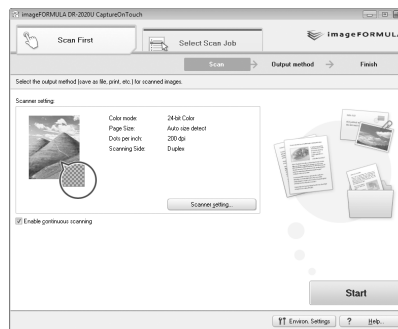

This method allows you to select an output method after a document is scanned, and then configure the necessary settings.

Select Scan Job

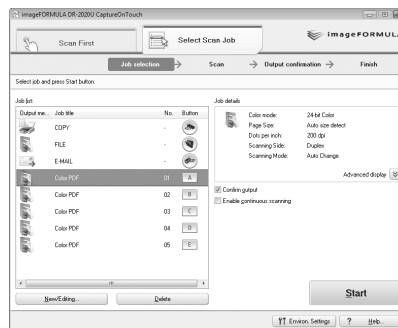

This method allows you to register scanning conditions and output methods as jobs, and then select a job that matches your intended purpose to begin scanning. This is useful for repeating specific scanning operations multiple times.

Scanning with the Job Buttons

[Scan First] and [Select Scan Job] are pre-assigned to the three job buttons on the operation panel, and you can start scanning by pressing one of buttons when “Scan First” appears on the display panel.

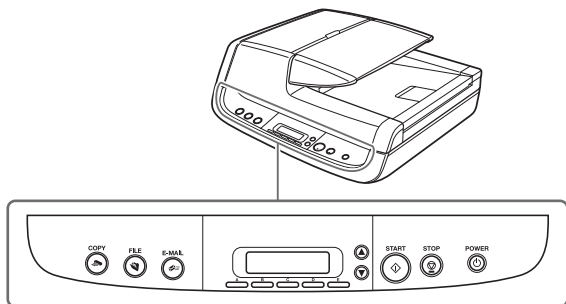

Starting CaptureOnTouch

CaptureOnTouch resides on your system when you log on to Windows, and a CaptureOnTouch icon appears on the taskbar (default).



When you double-click  (CaptureOnTouch), CaptureOnTouch starts and the main screen appears.

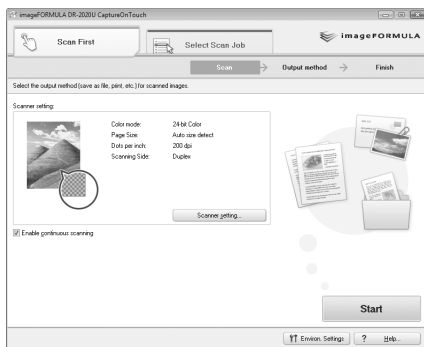

Hint

You can also start CaptureOnTouch from the Windows Start menu. Click [Start], point to [All Programs], point to [Canon DR-2020U], and then click [CaptureOnTouch].

Quitting CaptureOnTouch

Click  (CaptureOnTouch) in the notification area of the taskbar, and click [Exit] in the menu.

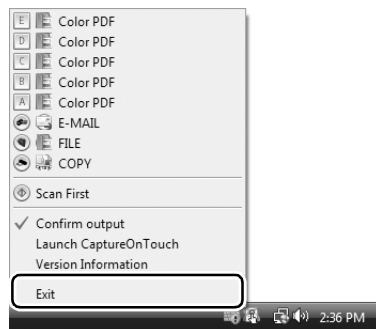

The application no longer resides on the system, and the taskbar icon disappears.

Restarting CaptureOnTouch

Press any job button on the scanner to restart CaptureOnTouch. CaptureOnTouch starts and the main screen appears.

Hint

- CaptureOnTouch resides on the system when it starts, and the CaptureOnTouch icon appears on the taskbar.
- You can also restart from the Windows Start menu. Click [Start], point to [Programs] (or [All Programs]), point to [Canon DR-2020U], and then click [CaptureOnTouch]. CaptureOnTouch starts and the main screen appears.

Scan First

Operation Flow

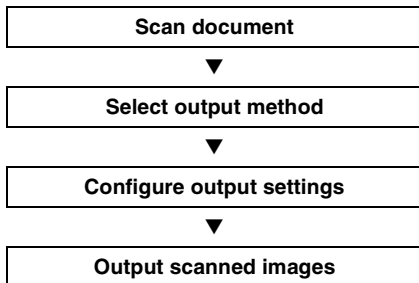

- 1 Place the document in the scanner (See p. 15).
- 2 Click the [Scan First] tab.



The main screen for [Scan First] appears.

- 3 Click [Scanner setting] to display the [Scanner setting] dialog box, and configure the scanner settings.

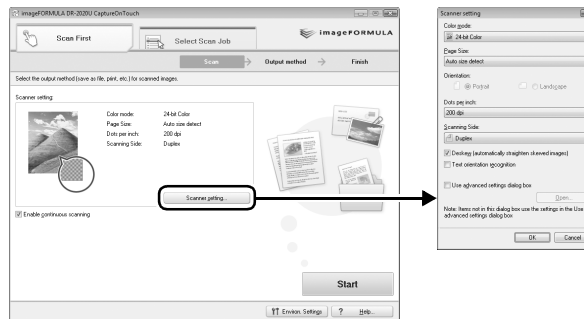

For details on scanner setting items, refer to the Help. When you are finished configuring, click the [OK] button to close the [Scanner setting] dialog box.

- 4 Click the [Start] button.

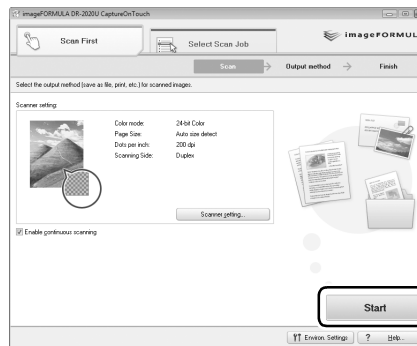

The document is scanned. While scanning is in progress, the number of pages scanned is displayed in addition to the scanner settings. When scanning is finished, the [Output method] screen appears in the main window.

5 Specify the output method.

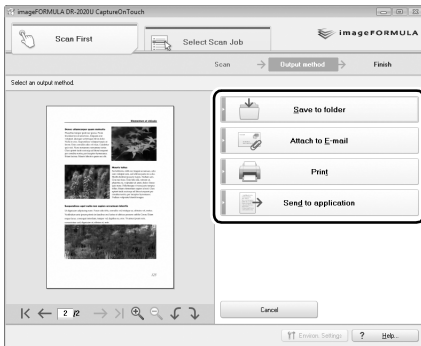

6 Configure settings for the output method, and click the output button to output the scanned images.

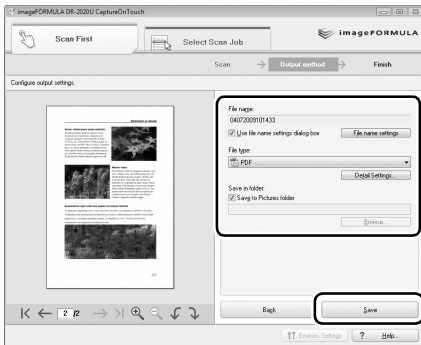

The name of the output button differs depending on the selected output method. If you select [Save to folder] for the output method, for example, the output button appears as [Save]. The completion screen appears after the scanned images are output. This completes [Scan First] scanning.

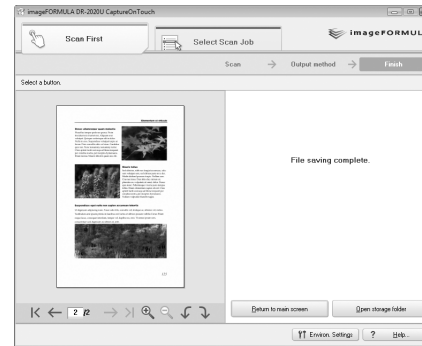

Hint

- Click [Return to main screen] to return to the main screen of [Scan First].
- If [Save to folder] is selected for the output method and you click [Open storage folder], the folder in which the scanned image files are stored will open.

Continuous Scanning

When you want to scan multiple documents as a single scanned image, or when you want to scan a multi-page document in sections, select the [Enable continuous scanning] check box in the main screen. (You can do this in [Scan First] and [Select Scan Job].)

In such cases, a confirmation screen to continue appears after the documents placed in the scanner are scanned. Perform one of the following.

- If you want to continue scanning another document, place the document in the scanner and click the [Continue scanning] button.
- If you are finished scanning documents, click the [Continue to next step] button.

Output Method Settings

CaptureOnTouch provides four output methods for processing scanned images. The output settings that appear differ depending on the output method selected.

[Save to folder]

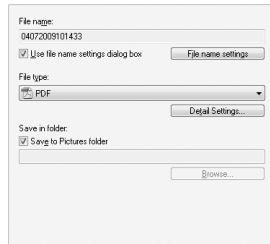

Save scanned images to a specified folder. When this method is selected, you must configure settings for the image file to be saved.

[Print]

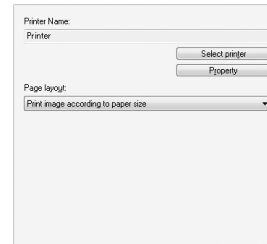

Print scanned images to a specified printer. When this method is selected, you must specify the printer to which images will be printed.

[Attach to E-mail]

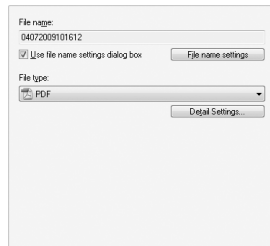

Start an e-mail application and attach scanned images to a new e-mail.

When this method is selected, you must configure settings for the image file to be attached.

The supported e-mail applications are Windows Mail and Outlook Express (both OS standard applications), MAPI-compatible (Microsoft Messaging Application Programming Interface) e-mail applications.

[Send to application]

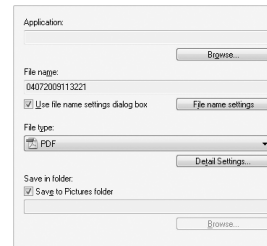

Open scanned images with a specified application. When this method is selected, you must click the [Browse] button and specify the executable file (.exe) for an application that can open the image file. In addition, configure settings for the image file to be saved.

When Using PaperPort

- The PaperPort application supplied with this unit uses the [Documents] folder by default. When sending the image file to PaperPort and specifying the save destination, be sure to specify the [Documents] folder or a folder within the [Documents] folder. Specifying any other folder may result in an error.
- If you want to specify a folder other than the [Documents] folder, use [Folder Manager] in PaperPort to register that folder beforehand.
- In Windows Vista, the documents folder and pictures folder are located on the same level in the folder hierarchy. As a result, be sure to register the pictures folder using [Folder Manager] in PaperPort if you want to specify that folder.

Starting [Scan First] with the START Button

Under default settings, [Scan First] is assigned to the START button on the operation panel.

When “Ready” appears on the display panel, press the START button after placing your document in the scanner. CaptureOnTouch starts up and [Scan First] begins. When document scanning is finished, the output method selection screen appears. Perform the procedure from step 5 onward to output the scanned images.

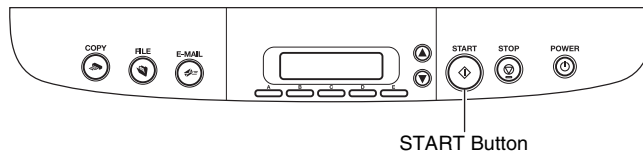

Hint

If “Ready” does not appear on the display panel (for example, the job title of a previous scan job will remain on the display after you perform the job), you can make it appear by pressing the STOP button.

CaptureOnTouch Scanner Settings

CaptureOnTouch provides the following settings for configuring scan conditions.



[Color mode]

Select the mode for scanning documents (auto color detection, color, grayscale, or black and white (binary)).

[Page Size]

Specify the page size of documents.

[Orientation]

Specify the orientation in which documents are fed into the scanner (portrait or landscape).

[Dots per inch]

Specify the scanning resolution.

[Scanning Side]

Specify whether to scan only one side of a document or both sides. If you select [Skip blank page] and a blank page is detected within the document while scanning, the blank page is skipped.

[Deskew]

When a document is scanned at an angle, the slant is detected and straightened in the scanned image.

[Text orientation recognition]

The orientation of text in scanned images is detected, and the images are rotated to match the orientation of the text.

[Use advanced settings dialog box]

Open the ISIS/TWAIN driver settings screen, and configure advanced scan conditions. For details on the settings in the driver settings screen, refer to the Help. (Click the [Help] button in the settings screen to open the Help.)

IMPORTANT

Certain settings are found in both the ISIS/TWAIN driver settings screen and the CaptureOnTouch scanner settings. If you clear the [Use advanced settings dialog box] check box after configuring ISIS/TWAIN driver settings, the CaptureOnTouch scanner settings are enabled.

Select Scan Job

Operation Flow

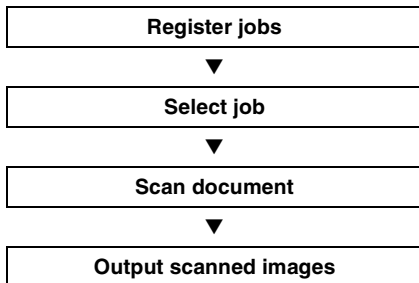

Registering/Editing Jobs

In CaptureOnTouch, you can register up to 10 jobs for use with [Select Scan Job].

1 Click the [Select Scan Job] tab.

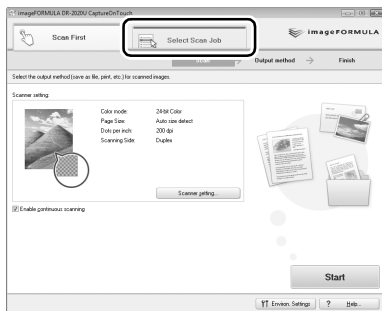

The main screen for [Select Scan Job] appears.

2 Click the [Register new job] button.

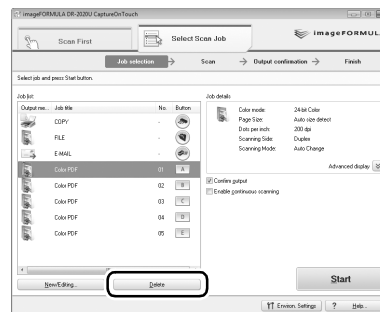

The [Register new job] dialog box appears.

Hint

If you select a registered job and click [Job list/edit], the [Job editing] dialog box appears allowing you to edit the settings of the selected job.

3 Configure the job settings.

- 1 Select an [Unconfigured] job number from the job list. If you select a job that is already registered, the title bar display changes to [Job editing].
- 2 Enter the job name.
- 3 Specify the output method.
- 4 Configure the job settings.

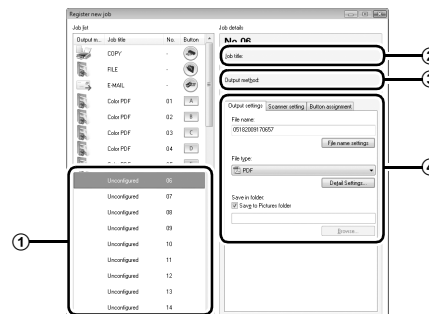

Job settings are configured in the following tabs.

[Output settings] tab

Configure settings for the output method. The items that appear in this tab differ depending on the [Output method] selected.

The screenshot shows the 'Output settings' tab with the following fields and options:

- File name: 06112009214522
- File name settings... button
- File type: PDF (selected)
- Default Settings... button
- Save in folder: Save to Pictures folder
- Browse... button

[File settings] tab

This tab appears when [Send by E-mail] is selected in the [Output method] list box. The items that appear in this tab are the same as those in the [Output settings] tab.

[Compose e-mail] tab

This tab appears when [Send by E-mail] is selected in the [Output method] list box. Configure e-mail settings for sending the scanned images.

In addition to these settings, you must also configure the environmental settings to send the e-mails to which the scanned images are attached. For details on settings, refer to the User Manual.

The screenshot shows the 'Compose e-mail' tab with the following fields and options:

- Mail address: [text field]
- History (H) button
- Reply-to address: [text field]
- Subject: [text field]
- Text: [text area]

[Scanner setting] tab

Configure scan conditions.

The screenshot shows the 'Scanner setting' tab with the following fields and options:

- Color mode: 24-bit Color
- Page Size: Auto size detect
- Orientation: Portrait (selected), Landscape
- Data per inch: 300 dpi
- Scanning Side: Duplex
- Deskew (automatically straighten skewed images)
- Text orientation recognition
- Use advanced settings dialog box
- Open... button
- Note: Items not in this dialog box use the settings in the Use advanced settings dialog box.

[Button assignment] tab

Configure settings to assign the job to a job button on the scanner. If [Assign scanner button 1 to Scan First] is selected in the main screen, assignment to job button 1 is not available.

The screenshot shows the 'Button assignment' tab with the following options:

- Select button to assign:
- A button
- B button
- C button
- D button
- E button
- Do not assign button

Confirming Output

In [Select Scan Job], scanned images are output according to the registered job settings. If [Confirm Output] is selected in the main screen, an output confirmation screen appears after documents are scanned, allowing you to confirm and change output settings for the scanned images.



Hint

You can also click the CaptureOnTouch icon in the taskbar, and enable or disable [Confirm Output] from the menu that appears.

4 Click the [OK] button.

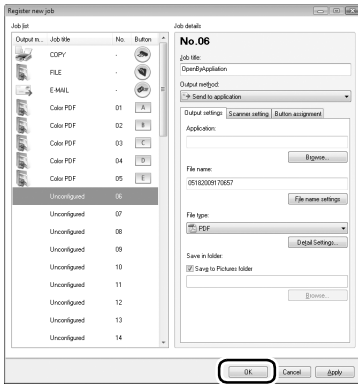

The job is registered according to the configured settings and appears in the job list.

To confirm the settings of a registered job or to change the settings, click the [Job list/edit] button.

Selecting Scan Jobs

1 Place the document in the scanner (See p. 15).

2 Click the [Select Scan Job] tab.

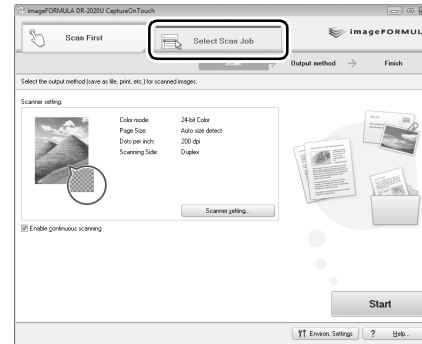

The main screen for [Select Scan Job] appears.

3 Click a job in the [Job list].

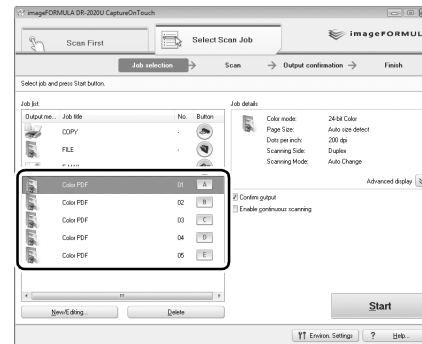

4 Click the [Start] button.

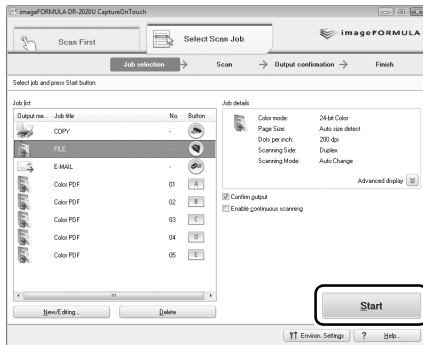

The document is scanned. While scanning is in progress, the number of pages scanned is displayed in addition to the scanner settings.

When all the pages of the document are scanned, the scanned images are output according to the registered job settings, and the completion screen appears.

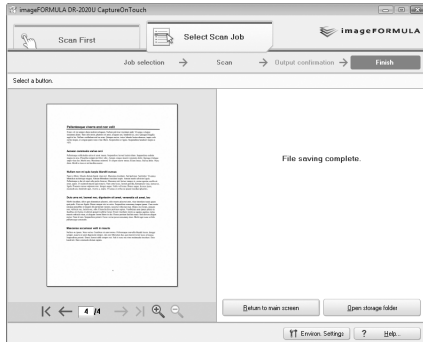

Hint

- Click [Return to main screen] to return to the main screen of [Select Scan Job].
- If [Save to folder] is selected for the output method and you click [Open storage folder], the folder in which the scanned image files are stored will open.

Starting [Select Scan Job] with the Job Buttons

The following, jobs are pre-assigned to the job buttons on the operation panel.

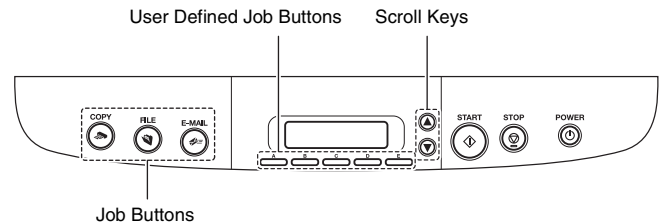

- Three preset jobs are assigned to the job buttons, and the respective scanning procedures will be processed automatically when these buttons are pressed.
- Registered jobs can be assigned to the user defined job buttons. When you press a user defined job button and then press the START button, the scan job assigned to the button begins.
- You can also select registered jobs using the scroll keys. When you press the START button, the selected scanning job begins.

Hint

If [Select Scan Job] is executed using a job button, CaptureOnTouch closes automatically 5 seconds after output processing is finished.

Troubleshooting

This section describes the problems that may occur while using the scanner and how to resolve them.

If you cannot resolve a problem, contact your local authorized Canon dealer or your service representative.

Common Problems and Solutions

Problem 1 The scanner will not turn on.

- Solutions
- (1) Confirm that the power switch is set correctly.
 - (2) Confirm that the AC adapter is plugged firmly into a power outlet.

Problem 2 The scanner is not recognized.

- Solutions
- (1) Confirm that the scanner is properly connected to the computer with a USB cable.
 - (2) Confirm that the scanner is turned on. See “Problem 1 The scanner will not turn on.”.
 - (3) The computer’s USB interface may not support the scanner. The scanner cannot be guaranteed to work with all USB interfaces.
 - (4) Confirm that the supplied USB cable is used to connect the scanner to the computer. The scanner cannot be guaranteed to work with all available USB cables.
 - (5) If the scanner is connected to the computer via a USB hub, try removing the hub and connecting directly to the computer.
 - (6) Disconnect the USB cable, and connect it again.

Problem 3 Documents feed askew (scanned images are slanted).

- Solutions
- (1) Align the document guides to fit the documents as closely as possible, and load the documents so that they feed straightly.
 - (2) Enable the [Deskew] scanner driver setting.
 - (3) If many pages have been scanned since roller cleaning, clean the rollers. If documents still feed askew, roller replacement or other maintenance may be needed. Refer to the page 32 for roller cleaning and replacement procedures.

Problem 4 Both sides are not scanned even when the Duplex scanner driver setting is enabled.

- Solutions
- In CaptureOnTouch or CapturePerfect 3.0, executing a job for which single-sided (simplex) scanning is registered will always result in simplex scanning, regardless of scanner driver settings. For example, if [Simplex] is selected under the [Scanner setting] tab of the [Job Register] dialog box in CaptureOnTouch, scanning will always be single-sided for that job. Even if you configure scanner driver settings from [Scan Batch to File] under the [Scan] menu in CapturePerfect 3.0, a job will always be performed according to its registered settings. To perform duplex scanning, either change the job setting or create another job for duplex scanning.

Problem 5 If white lines or streaks appear in scanned images.

- Solutions
- Clean both sides of the scanner glass, and the rollers (both rubber and metal). If a sticky substance such as glue or correction fluid is found, carefully wipe with just enough pressure to clean the area where the lines appear. If the problem cannot be solved by cleaning, the internal glass may be scratched. Contact your local authorized Canon dealer.

Problem 6 Pages are missing.

- Solutions
- When the scanner driver’s [Scanning Side] setting is [Skip Blank Page], documents with very little black may be unintentionally skipped. Select another scan mode setting such as [Simplex] or [Duplex], or decrease the [Ratio of black pixels]. If pages are skipped due to the document double feeding, see “Problem 7 Documents jam (or double-feed).”.

Problem 7 Documents jam (or double-feed).

- Solutions
- (1) Clean the feed rollers if necessary.
 - (2) Proper scanning may not be possible when document pages stick together due to static electricity. Fan the documents before you load them.

Problem 8 Each scanned image of a multi-page document is saved as a separate document.

Solutions With CaptureOnTouch, you can scan multiple pages into one image file when TIFF or PDF file format is selected. To do this, select [File type], click the [Detail Settings] button, and select [Save all pages as one file] in the displayed dialog box.
When you select [Scan Batch to File] from the [Scan] menu in CapturePerfect, a dialog box appears with a pull-down menu at the bottom that allows you to select [Single Page], [Multi Page (All Pages)], or [Multi Page (Specified Pages)]. If you select [Single Page], each page of a multi-page document is saved as a separate image file. To save multiple pages to a single image file, select [Multi Page (All Pages)] or [Multi Page (Specified Pages)].

Problem 9 Documents feed, but no scanned images are saved.

Solutions When Panel-Feeding is selected as the feeding method on the scanner driver's setting screen, after a document is fed, scanning does not occur until the scan button is clicked on the scan panel.

Problem 10 Scanned images of multiple pages cannot be saved in a single JPEG or BMP file.

Solutions Multiple scanned images cannot be saved in a single JPEG or BMP file. Save the images in either TIFF or PDF format.

Problem 11 An error message is displayed.

Solutions Confirm the nature of the error, and resolve the problem. Press the STOP button to clear the error message. The solution for each error is as follows.

Error Message	Solution
Paper jammed in scanner; clear paper and push STOP button.	A paper jam has occurred. Remove the jammed paper. (See p. 30.)
The scanner cover or upper unit is open. Remove jammed paper, and push STOP button.	Close the scanner cover or upper unit.
Release the lock switch. After releasing the lock switch, press the STOP button.	The lock switch is locked. Unlock the lock switch.
Feeder is not Connected.	The ADF connector on the rear panel of the scanner is disconnected. Insert the ADF connector all the way.
A double paper-feed has occurred. Please check the document and the scanned image on the display and scan the document again.	Scanning has stopped due to document double-feed. Check the scanned images to confirm how much of the document was scanned, and continue scanning accordingly.

Problem 12 Cannot perform ADF scanning.

Solutions Scanning cannot be performed from the feeder when the business card feeder is open. Close the business card feeder if it is open.

Problem 13 Auto start does not function.

Solutions The document detection sensor on the feeder does not function when the business card feeder is open. Therefore, even if documents are placed in the feeder, scanning will not begin automatically if the business card feeder is open. Close the business card feeder.

Problem 14 The "Warming up" message appears.



Solutions If this procedure is performed immediately after turning the scanner ON or while the power indicator is not lit, the following appears on the computer display. In this case, scanning begins after the scanner finishes warming up. Warm up may take up to 30 seconds.

Clearing a Paper Jam

If a paper jam occurs while scanning from the feeder, an error message appears on the display panel. Follow the procedure below to clear the jam.

CAUTION

Be careful not to cut your fingers on the edges of the paper when clearing the paper jam.

1 Remove any documents remaining in the document feed tray and the eject outlet.

2 Open the feeder cover, and confirm the location of the paper jam.

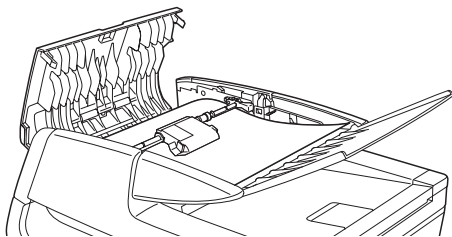

Hint

If the paper jam is not inside the feeder cover, check the underside of the feeder or the eject outlet.

3 If the jammed document does not appear wrinkled or otherwise damaged, close the feeder cover, and press the **STOP** button.

The jammed document is ejected, and the error message is cleared on the display.

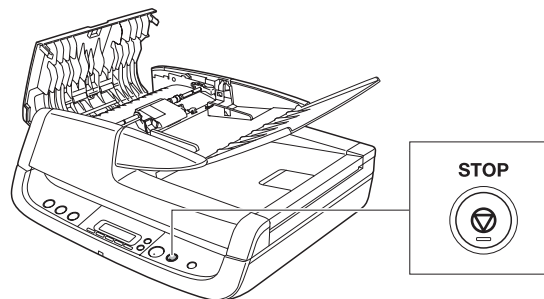

4 If the document is jammed at an angle or wrinkled, carefully remove the document without tearing it.

IMPORTANT

Remove the document carefully, and do not pull with excessive force. Should the document tear, always be sure to remove any pieces of paper remaining in the scanner.

5 Close the feeder cover gently.

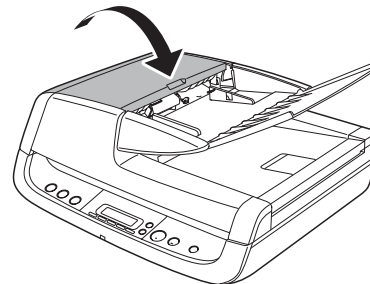

CAUTION

When closing the feeder cover, be careful not to get your fingers caught, as this may result in personal injury.

6 Press the **STOP** button to clear the error message on the display.



After clearing the paper jam, confirm whether the last document was scanned before you continue scanning.

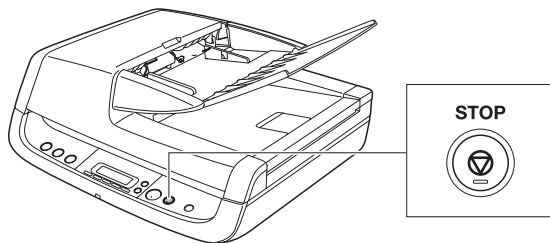

Appendix

Cleaning the Roller Unit and Separation Pad

If streaks appear in scanned images, or if scanned documents become dirty, the roller unit and separation pad may be dirty. Be sure to clean them regularly.

 **Hint**

The roller unit and separation pad are located inside the feeder cover. Be sure to remove the roller unit and separation pad, as shown below, before cleaning them.

Removing the Roller Unit and Separation Pad

- 1 Open the document feed tray and feeder cover.

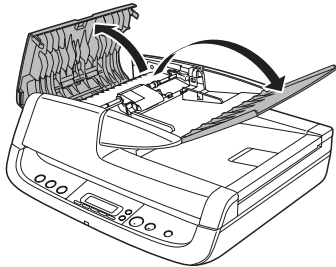

- 2 Raise the roller unit's lock lever. (Gently bend the lock lever inward, then raise it.)

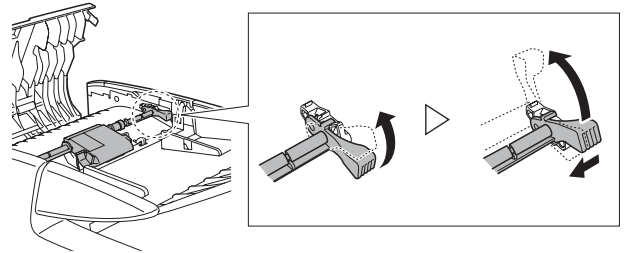

- 3 Remove the roller unit.
Hold the center of the roller unit (roller portion), lift the lock lever side (1), then the other side (2).

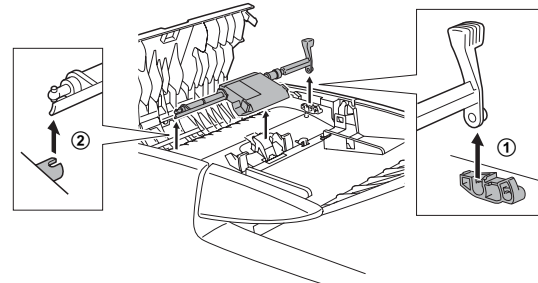

-
- 4** Grasp both sides of the separation pad with your fingers, and remove the separation pad.

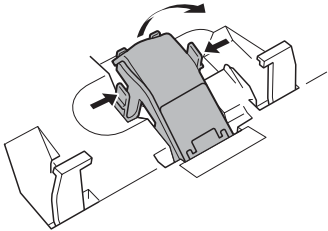

-
- 5** Use a cloth dampened with water and thoroughly wrung out to wipe the rollers and separation pad clean.

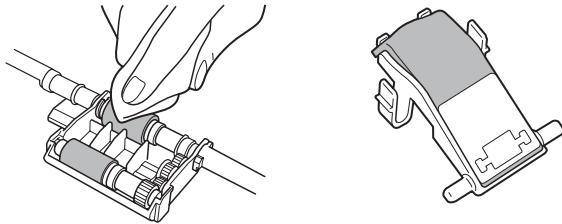

Attaching the Roller Unit and Separation Pad

-
- 1** Attach the separation pad.

Press the separation pad down gently until it snaps into place, and make sure it is securely attached.

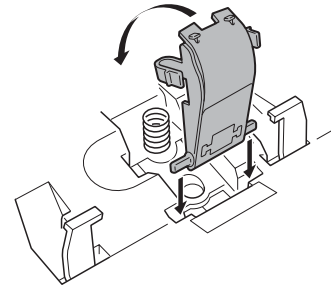

-
- 2** Attach the roller unit.

Insert the shaft pin of the roller unit into the notch on the scanner (①), and attach the lock lever vertically (②).

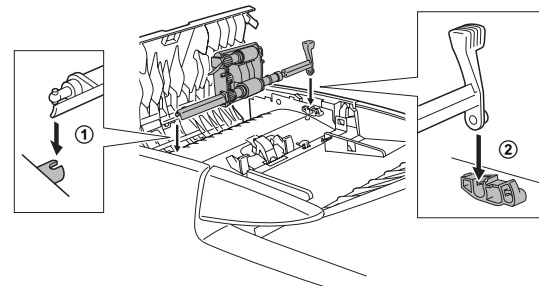

- 3** Lower the lock lever to secure the roller unit into place. You can lower the lock lever smoothly by gently bending it inward.

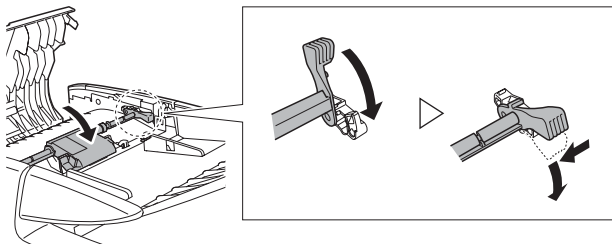

- 4** Close the feeder cover and document feed tray.

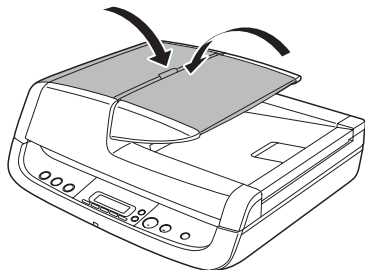

CAUTION

When closing the feeder cover and document feed tray, be careful not to get your fingers caught, as this may result in personal injury.

IMPORTANT

The separation pad and roller unit are consumable parts. If performance does not improve after cleaning the separation pad and roller unit, the parts may need to be replaced. Contact your local authorized Canon dealer. When replacing the parts, first replace the separation pad. If performance does not improve, replace the roller unit as well.

Specifications

Scanner

Type Desktop ADF/flatbed scanner

Document Size

Feeder Width: 140 mm to 216 mm
Length: 100 mm to 356 mm
Thickness: 52 to 128 g/m² (0.06 mm to 0.15 mm)
Capacity: 50 sheets or stacked to a height of 5.0 mm (including curling)

Flatbed Width: 216 mm
Length: 297 mm

Business Card Feeder

Width: 49 mm to 55 mm
Length: 85 mm to 91 mm
Thickness: 128 to 300 g/m² (0.15 mm to 0.3 mm)
Capacity: 15 sheets or stacked to height of 3.8 mm (including curling)

Feeding Method

Automatic

Scanner Element

CCD (Charge-Coupled Device)

Light Source

CCFL (Cold Cathode Fluorescent Lamp)

Scanning Sides

Simplex, Duplex, Skip blank pages

Scanning Modes

Black and White, Advanced Text Enhancement, Advanced Text Enhancement II, Error Diffusion, 256-level Gray, 24-bit Color, Smoothing Color

Scanning Resolution

(primary scan lines × secondary scan lines)

100 × 100 dpi, 150 × 150 dpi, 200 × 200 dpi, 240 × 240 dpi, 300 × 300 dpi, 400 × 400 dpi, 600 × 600 dpi

Scanning Speed (A4, 200 dpi, Simplex)

Feeder Black and White: 20 ppm
Gray: 20 ppm
Color: 20 ppm

Interface Hi-Speed USB 2.0

Dimensions

440 mm (W) × 400 mm (D, excluding ADF cable) × 180 mm (H)

Weight Approx. 7.8 kg

Power Consumption

Scanning: Maximum 33.0 W

In the Sleep Mode: Maximum 3.7 W

With power switch OFF: Maximum 0.5 W

Noise 64 dB or less

Operating Environment

Temperature: 10°C to 32.5°C

Humidity: 20% to 80% RH

AC Adapter

Model Number

MG1-4314

Input AC 100 V - 240 V, 50/60 Hz, 1.2 A (100 V) - 0.7 A (240 V)

Output DC 24 V, 2.2 A

Weight Approx. 0.4 kg

Specifications are subject to change without notice.

Replacement Parts

Roller Unit

Product Code: 4048B001

Separation Pad

Product Code: 4048B002

- For details on replacing the roller unit and separation pad, see “Cleaning the Roller Unit and Separation Pad” on p. 32.
- For further details on replacement, contact your local authorized Canon dealer.



CANON ELECTRONICS INC.

1248, SHIMOKAGEMORI, CHICHIBU-SHI, SAITAMA 369-1892, JAPAN

CANON U.S.A. INC.

ONE CANON PLAZA, LAKE SUCCESS, N.Y. 11042, U.S.A.

CANON CANADA INC.

6390 DIXIE ROAD, MISSISSAUGA, ONTARIO L5T 1P7, CANADA

CANON EUROPA N.V.

BOVENKERKERWEG 59-61, P.O.BOX 2262, 1180 EG AMSTELVEEN, THE NETHERLANDS

CANON LATIN AMERICA, INC.

703 WATERFORD WAY, SUITE 400 MIAMI, FLORIDA 33126, U.S.A.

CANON AUSTRALIA PTY. LTD.

1 THOMAS HOLT DRIVE, NORTH RYDE, SYDNEY. N.S.W, 2113. AUSTRALIA

CANON SINGAPORE PTE. LTD.

1 HARBOUR FRONT AVENUE #04-01, KEPPEL BAY TOWER, SINGAPORE 098632

CANON HONGKONG COMPANY LTD.

19TH FLOOR, THE METROPOLIS TOWER, 10 METROPOLIS DRIVE, HUNGHOM, KOWLOON, HONG KONG.

CANON KOREA BUSINESS SOLUTIONS INC.

168-12 SAMSEONG-DONG, GANGNAM-GU, SEOUL, KOREA