

Canon

SURE SHOT
150u / SURE SHOT
150u
DATE

PRIMA
SUPER **150u** / PRIMA
SUPER **150u**
DATE

Instructions

Handling Precautions

- Before taking pictures of important events, such as weddings and trips, check to make sure the camera is working properly.
- This camera is not resistant to water, and should not be used outdoors if it is raining or snowing. Keep the camera out of salt spray and excessive humidity. If used at the beach, clean it thoroughly afterward with a dry cloth.
- Store the camera in a cool, dry, dust-free place. Be sure to keep the camera out of direct sunlight, and away from "hot spots" such as the trunk or rear window shelf of a car. Avoid places where mothballs are used, and use a desiccant in excessive humidity.
- Do not attempt to disassemble the camera yourself, since there is high-voltage circuitry inside.
- The battery may explode or cause burns if disassembled, recharged, shorted, exposed to high temperatures, or disposed of in a fire.
- Use a blower brush to remove dust and sand from the lens and inside the camera. Do not apply any fluids to the lens or body.

Convention



Warnings you should observe when using the camera.



Additional information on using the camera.

Please note that these instructions are for both the model with the date function and model without date function. Information relevant only to the model with the date function is marked with the **DATE** symbol.

Loading the Battery and Checking the Battery Level

Loading the Battery

Applicable Battery: One lithium battery (CR2)

1 Open the battery cover.

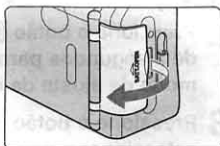

2 Load a new battery.

- Align the + - terminals correctly and insert the battery - end first.
- The appears on the LCD panel.

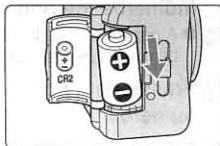

3 Close the battery cover.

- Push the cover closed until you hear a clicking sound.
- The date display "-- --" on the LCD panel blinks. Set the date and time.

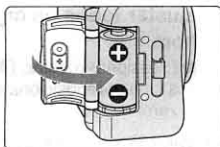

The camera will not operate if the + - terminals are aligned incorrectly.

Checking the Battery Level

Check that appears on the LCD panel when you turn the power on. Change the battery if is displayed.

(lit) The battery level OK.

(lit) Prepare a new battery.

(blinking) Load a new battery.

A new battery will generally provide enough charge to shoot approx. 14 rolls of 24-exposure film (based on Canon's Standard Test Method at normal temperature and with 50% flash use). At low temperatures (-10°C/14°F), the battery life is approximately one third of the normal figure.

When you take consecutive shots using the flash, the battery level may drop off temporarily and prevent the LCD panel from displaying information correctly.

Loading and Removing the Film

■ Loading the Film

1 Open the back cover and load the film.

- Push the back cover release lever down.

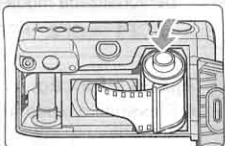

2 Position the film correctly between the film guides.

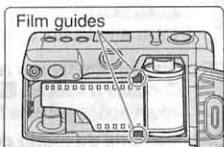

3 Pull the film out to the (film leader position indicator).

- Make sure that there is no slack in the film when you pull it out.
- If the edge of the film leader goes beyond the film leader position indicator, rewind some of the film back into the cartridge.

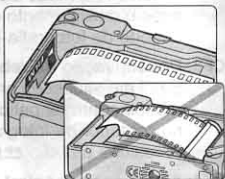

4 Close the back cover.

- ➔ The film automatically winds on to the first frame and "1" appears on the frame counter.
- If the frame counter shows a blinking "0", the film did not load correctly. Load the film again.

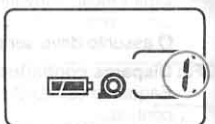



-  ISO 400 DX-coded film is recommended. The film speed is set to ISO 25 when non-DX film is loaded. If the film does not have a DX-code, insert it into the film compartment, close the back cover and press the shutter button once or twice.

■ Removing the Film

The film rewinds automatically when it reaches the end.

When the film is fully rewound, the frame counter shows "0" and the  blinks. Then open the back cover and remove the film.

- If the  is not blinking, press the  button.

-  If you take more pictures than stipulated on the film, the last frame is cut during developing, and the date and time may not be imprinted on the last frame.

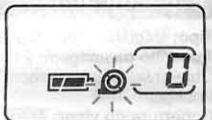



Taking Pictures in Autoflash (Full-auto) Mode

As long as the subject is in the wide area AF frame, the subject will be in focus. The flash also fires automatically in low light or backlit conditions.

1 Press the main switch to turn the camera on.

2 Decide on the size of your subject.

- Pressing  zooms in on your subject while pressing  zooms out for a wide-angle shot.

3 Set the focus.

- Position the wide area AF frame over your subject and lightly press the shutter button halfway down.
- ➔ When the subject is in focus, the green lamp lights.
- Keep the shutter button pressed halfway.

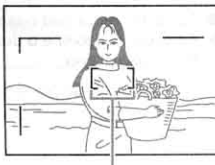

Wide area AF frame

4 Compose the shot and take the picture.

- Press the shutter button fully.
- Press the shutter button slowly and gently.

Holding the Camera

Grasp the camera firmly with both hands so that it does not move, and make sure that your hair, fingers or camera strap etc. do not come into contact with the lens, the AF sensor/metering window or the flash.

● Shutter Button

The shutter button is a two-stage switch. Lightly press it halfway to automatically determine focus and exposure. Press it fully to take the picture.

- If the lens is left extended and is not used for 4 minutes, it is automatically retracted to wide-angle position.

- In dark places, the AF-assist beam emitter will light automatically.

Using Focus Lock

Lock the focus when you want the subject to be off center, or when the subject is within 1.5 m/4.9 ft. of the camera.

1 Set the focus.

- Position the wide area AF frame over your subject and lightly press the shutter button halfway down. Keep the shutter button pressed halfway.

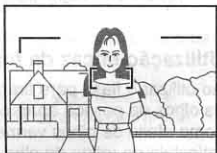

2 Compose the shot and take the picture.

- Compose the shot and press the shutter button fully.

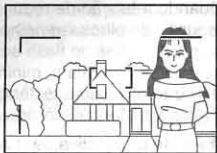

- ⚠ Take care that the distance from the camera to the subject does not change. If the distance does change, lock the focus again.

Close-up Photography

When the shooting distance is closer than 1.5 m/4.9 ft., there is a difference between what you see in the viewfinder and the picture you actually take, and therefore the part of the picture outside the close-up frame will be cut off.

After locking the focus on your subject, bring the subject into the close-up frame, compose the shot and take the picture.

Close-up frame

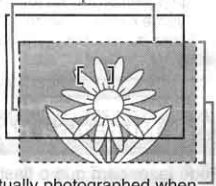

Area actually photographed when the lens is in the telephoto position (inside dotted line).

- ⚠ If the green lamp blinks, move away from the subject until the lamp stops blinking.

Shooting with the Mode Button

Select the shooting mode.

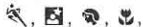
- Press the **MODE** button, and align ▼ with  with **RT**.

  uses center-point AF to focus in the center of the wide area AF frame.

Shooting Moving Objects

This mode selects servo autofocus, which keeps moving objects in focus, and the continuous shooting function.

- In low light or backlit conditions, the flash fires automatically.
- You may not be able to focus on subjects moving rapidly.
- The red-eye reduction function can not be set.
- The green lamp does not light.
- No camera shake warning is given.
- The camera continues to adjust the focus for 40 seconds while the shutter button is held down halfway.
- Even if set, the Real-time Release Custom Function (CF1) will not operate.

Shooting against Dark Backgrounds

Use this mode when you are taking pictures of people against a sunset or nighttime background.

The flash illuminates the subject and the slow shutter speed captures the background, allowing you to take beautiful pictures.

- Follow the steps in autoflash mode to take a picture.
- The red-eye reduction function will operate.

- You cannot change the flash mode.
- No camera shake warning is given. Because of the slow shutter speeds (up to 2 seconds), you must use a tripod to keep the camera steady. You should also ensure that the subject does not move in the moment after the flash fires.

Shooting Portraits

Use this mode when you want to lessen the impact of the background and highlight the subject.

The camera automatically zooms in, to a range of 1 to 3.7 m/3.3 to 12.1 ft. to frame from the waist up of the subject and fires the flash for every shot to produce highlights in the subject's eyes.

- Follow the steps in autoflash mode to take a picture.
- The red-eye reduction function will operate.

Shooting Close-up

Use this mode when you want to take close-up pictures of flowers and insects.

You can get as close to 60 cm/2 ft. to the subject to take a picture. The shooting distance range is between 0.6 m/2 ft. to infinity.

- Refer to **Close-up Photography** for the procedure to shoot in close-up.

- The lens automatically zooms and locks into position. You cannot operate the zoom.

RT Shooting in Real Time

Press the shutter button down halfway to focus on the subject and then press the button fully to take a picture in real time. This mode enables you to take pictures at the best moment.

- If you press the shutter button all the way down in a single movement, realtime release does not operate.

Using Red-eye Reduction Function Effectively

When you use the flash to take photos of people in low light conditions, their eyes sometimes glow red in the photograph. This is referred to as the red-eye effect and is caused by the light of the flash being reflected off the retina of the eye.

When the red-eye reduction operates, the red-eye reduction lamp lights for approximately 1 second before the flash fires. This causes the subject's pupils to contract, minimizing the risk of red-eye.

- ① Take the picture from within 2 m/6.6 ft. of your subject.
 - ② Attract the subject's attention so that he or she looks at the camera.
- Set the lens to the wide-angle position.
 - Raise the available light level as much as possible.
 - The effectiveness of the red-eye reduction function varies from person to person.

⚠ When the red-eye reduction function operates, a picture can not be taken for approximately 1 second (the green lamp blinks 16 times). Hold down the shutter button until you hear the sound of the film winding on.

⚡👁 Changing the Flash Mode

You can cause the flash to fire for every shot or suppress flash operation completely to suit the subject or location.

Select the flash mode.

- Press the ⚡👁 button to select the mode you want.

AUTO ⚡ Autoflash

In dark places and in backlit conditions, the flash fires automatically.

Flash Distance Range (with color print film)

Film speed	Wide-angle	Telephoto
ISO 100	0.8–3.4 m (2.6–11.2 ft.)	1.0–2.5 m (3.3–8.2 ft.)
ISO 200	0.8–4.8 m (2.6–15.7 ft.)	1.0–3.5 m (3.3–11.5 ft.)
ISO 400	0.8–6.8 m (2.6–22.3 ft.)	1.0–5.0 m (3.3–16.4 ft.)

📄 You can select whether the autoflash mode initially set when you turn the power on is AUTO ⚡👁 or AUTO ⚡. Set the camera to the desired autoflash mode and then switch the camera off.

AUTO ⚡👁 Autoflash with Red-eye Reduction

In dark places, the flash automatically fires after the red-eye reduction lamp has lit.

⚡ Flash ON (Fires for all shots)

The flash fires when the picture is taken.

⚡👁 Flash ON with Red-eye Reduction (Fires for all shots)

The flash always automatically fires after the red-eye reduction lamp has lit.

🚫 Flash OFF (Never fires)

The flash does not fire.

⚡ +1.5

⚡ -1.5

Flash OFF with Manual Exposure Compensation

There is automatic exposure compensation in backlit conditions but manual exposure compensation is also optional.

● 🚫 +1.5 Exposure Compensation

You can use this setting to prevent your subject being too dark (underexposed) when the surroundings are extremely bright, such as at a ski-resort or in backlit conditions.

● 🚫 -1.5 Exposure Compensation

You can use this setting to prevent your subject being too bright (overexposed) when the surroundings are extremely dark, such as on a spotlight stage.

⚠ Because of the slow shutter speeds in dark places in 🚫 +1.5, and 🚫 -1.5 modes, if the camera shake warning comes on (the green lamp blinks 16 times per second), you must use a tripod to keep the camera steady.

Imprinting the Date and Time DATE

1 Select the Date mode.

- With the power off, press the **MODE** button.

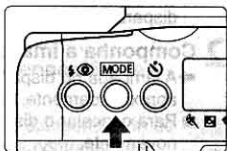

2 Select the date and time combination.

- By pressing the **[▲]** button, you can select the date and time combination. The display changes in the cycle shown below.

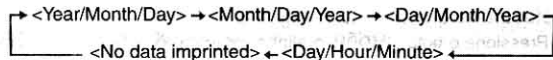

- Press the **MODE** button and the power switches off.



Date/time etc. imprinted here.

■ Setting the Date and Time

When you replace the battery or travel to the different time zone, use the following procedure to set or adjust the date and time settings.

1 Select the Date mode.

2 Press the **[▲▲▲]** button for more than 2 seconds for date/time set mode.

3 Press the **[▲▲▲]** button to select the setting position (numbers blinking).

- Setting position cycles through in the order **year-month-day-hour-minute(·)**.

4 Press the **[▲]** button to set the number.

5 Repeat 3 and 4 above to set all digits of the date and time.

- Pressing the **[▲]** button while "·" is blinking resets the seconds (·) setting to zero.

6 Finish setting the date and time.

- Press the **[▲▲▲]** button and once "·" stops blinking, date and time setting is completed.
- Press the **MODE** button and the power switches off.

Setting the Date

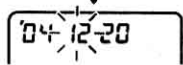
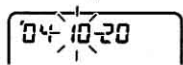
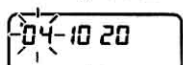

Setting the Time

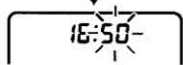
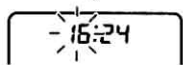
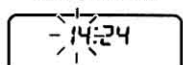



Each time the **[▲]** button is pressed, the number increases by one. If kept pressed, the number increases continuously.

Setting the Custom Functions

You can customize the functions listed below to suit your preferences or the photography conditions.

1 Set the camera to Custom Function setting mode.

- With the power off, hold down the  button and press the  button.
- ➔ "CF 1-0" appears on the LCD panel.

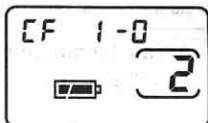



2 Select a function.

- Each time you press the  button, the Custom Function number changes in the cycle shown below.

➔ CF1 → CF2 → CF3 → CF4 → CF5

3 Set the function.

- Press the  button to change the setting display to 1 (function enabled).
Press the  button again to change the setting to 0 (function disabled).
- Turning the power on completes the settings.



CF1: Real-time Release

Refer to  **Shooting in Real Time** for information on using the Real-time Release function.

CF2: Shooting Mode and Flash Mode Memory

Stores the shooting mode and the flash mode in memory immediately before the camera is switched off. Useful when you always want to set the shooting mode and the flash mode to a particular mode.

CF3: Disabling Automatic Film Rewind

Useful for situations where you do not want the sudden sound of the film rewinding. When you reach the end of the roll, the number on the frame counter and the  blink. Press the  button to start film rewinding.

CF4: Center-point AF

A convenient function when you want to place your subject off center (using focus lock) or focus on one particular subject. The subject must be positioned in the center of the wide area AF frame.

CF5: Continuous Shooting

While the shutter button is pressed, you can take continuous shots.



- The Custom Functions were all set to zero (0) at the factory setting.
- The Custom Function settings are retained even when you switch the camera off and on, replace the film, or replace the battery.

Major Specifications

Type: Fully-automatic 35 mm lens-shutter AF camera

Image Size: 24 × 36 mm

Lens: Canon zoom lens 38-150 mm f/5.6-11.3

Focusing: AI AF

Viewfinder Coverage: Approx. 84%

Viewfinder Information: Picture frame, Wide area AF frame, Close-up frame

Green lamp: Camera ready indicator/too-close warning/focusing-not-possible warning/release lock while the red-eye reduction lamp is lit/camera shake warning

Shooting Distance: Wide-angle: 0.8 m (2.6 ft.)-infinity

Telephoto: 1.0 m (3.3 ft.)-infinity

Close-up: 0.6 m (2 ft.)-infinity

Film Speeds: DX-coded ISO 25-3200 set automatically in full-stop increments

Film Transport: Automatic, mid-roll rewind

Power Source: One CR2 lithium battery

Battery Life: Approx. 14 rolls (24-ex. • normal temperature with 50% flash use)

Dimensions (W × H × D): 107 × 58.7 × 51.5 mm/4.2 × 2.3 × 2 in.

Weight: 200 g/7.1 oz. (excluding battery)

- All the specifications above are based on Canon's testing and measuring standards.
- Specifications and physical appearance are subject to change without notice.

This device complies with Part 15 of the FCC Rules. Operation is subject to the following two conditions: (1) This device may not cause harmful interference, and (2) this device must accept any interference received, including interference that may cause undesired operation.

Do not make any changes or modifications to the equipment unless otherwise specified in the instructions. If such changes or modifications should be made, you could be required to stop operation of the equipment.

This equipment has been tested and found to comply with the limits for a class B digital device, pursuant to part 15 of the FCC Rules. These limits are designed to provide reasonable protection against harmful interference in a residential installation. This equipment generates, uses and can radiate radio frequency energy and, if not installed and used in accordance with the instructions, may cause harmful interference to radio communications.

However, there is no guarantee that interference will not occur in a particular installation. If this equipment does cause harmful interference to radio or television reception, which can be determined by turning the equipment off and on, the user is encouraged to try to correct the interference by one or more of the following measures:

- Reorient or relocate the receiving antenna.
- Increase the separation between the equipment and receiver.
- Consult the dealer or an experienced radio/TV technician for help.

This digital apparatus does not exceed the Class B limits for radio noise emissions from digital apparatus as set out in the interference-causing equipment standard entitled "Digital Apparatus", ICES-003 of the Industry Canada.

Cet appareil numérique respecte les limites de bruits radioélectriques applicables aux appareils numériques de Classe B prescrites dans la norme sur le matériel brouilleur: "Appareils Numériques", NMB-003 édictée par l'Industrie Canada.

Canon

CANON INC.

30-2, Shimomaruko 3-chome, Ohta-ku, Tokyo,
146-8501, Japan

U.S.A.

CANON U.S.A. INC.

One Canon Plaza, Lake Success, N.Y.
11042-1198

For all inquiries concerning this camera, call
toll free in the U.S.
1-800-OK-CANON

CANADA

CANON CANADA INC. HEADQUARTERS

6390 Dixie Road, Mississauga, Ontario, L5T
1P7, Canada

CANON CANADA INC. MONTREAL BRANCH

5990, Côte-de-Liesse, Montréal Québec,
H4T 1V7, Canada

CANON CANADA INC. CALGARY OFFICE

2828, 16th Street, N.E. Calgary, Alberta,
T2E 7K7, Canada

For all inquiries concerning this camera, call
toll free in Canada
1-800-OK-CANON

EUROPE, AFRICA & MIDDLE EAST

CANON EUROPA N.V.

Bovenkerkerweg 59-61, P.O. Box 2262,
1180 EG Amstelveen, The Netherlands

CANON COMMUNICATION & IMAGE

FRANCE S.A.

102, Avenue du Général de Gaulle 92257
La Garenne-Colombes Cedex, France

CANON UK LTD.

Woodhatch Reigate Surrey RH2 8BF,
United Kingdom

CANON DEUTSCHLAND GmbH

Europark Fichtenhain A10, 47807 Krefeld,
Germany

CANON ITALIA S.p.A.

Via Milano 8, I-20097 San Donato Milanese
(MI) Italy

CANON Schweiz AG

Industriestrasse 12, CH-8305 Dietlikon,
Switzerland

CANON GmbH

Oberlaaerstrasse 233, 4th floor, 1100 Wien,
Austria

CANON España, S. A.

C/Joaquín Costa, 41, 28002 Madrid, Spain
SEQUE Soc. Nac. de Equip., Lda.,
Praça da Alegria, 58, 2°, 1269-149 Lisboa,
Portugal

CENTRAL & SOUTH AMERICA

CANON LATIN AMERICA, INC.

703 Waterford Way Suite 400 Miami, FL
33126 U.S.A.

ASIA

CANON HONGKONG CO., LTD.

9/F, The Hong Kong Club Building, 3A
Chater Road, Central, Hong Kong

CANON SINGAPORE PTE. LTD.

79 Anson Road #09-01/06 Singapore
079906

OCEANIA

CANON AUSTRALIA PTY. LTD.

1 Thomas Holt Drive, North Ryde, N.S.W.
2113, Australia

CANON NEW ZEALAND LTD.

Akoranga Business Park, Akoranga Drive,
Northcote, Auckland, New Zealand

JAPAN

CANON SALES CO., INC.

16-6 Kohnan, 2-chome, Minato-ku, Tokyo,
108-8011, Japan

■ Nomenclature

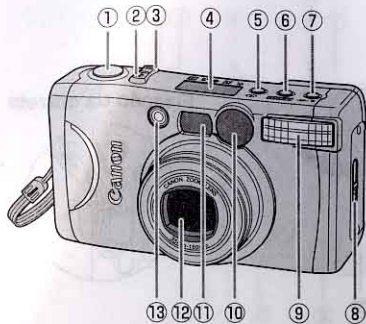

Front

- ① **Shutter button**
- ② Zoom-in (telephoto)/
Set **DATE** button
- ③ Zoom-out (wide-angle)/
Selection **DATE** button
- ④ LCD panel
- ⑤ Self-timer button
- ⑥ **MODE** Mode button
- ⑦ Flash mode button
- ⑧ Back cover release lever
- ⑨ Flash
- ⑩ Viewfinder window
- ⑪ AF sensor/metering window
Soiling on the AF sensor causes focusing
problems. Wipe off any dust or dirt before taking
pictures.

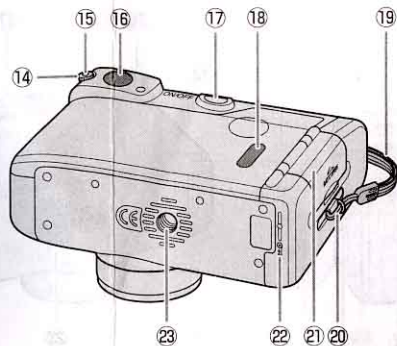

- ⑫ Lens
Soiling on the lens causes focusing problems.
Wipe off any dust or dirt before taking pictures.
- ⑬ Red-eye reduction/Self-timer lamp/
AF-assist beam emitter
- ⑭ Dioptic adjustment knob
Turn this knob to adjust the focus when you
cannot see the viewfinder image clearly.
- ⑮ Green lamp
- ⑯ Viewfinder eyepiece

Back

⑰ Main switch

Pressing the main switch turns the camera on and sets the lens to the wide-angle position. If you press it again, the lens retracts, the lens cover closes and the camera switches off. When you switch the camera off, the display on the LCD panel does not disappear.

⑱ Film check window

⑲ Strap

⑳ Strap mount

㉑ Battery compartment cover

㉒ Mid-roll rewind button

Hold this button down until the film starts to rewind.

㉓ Tripod socket

Attaching the Strap

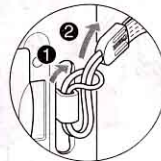

LCD Panel

(Normally, only necessary information displayed)

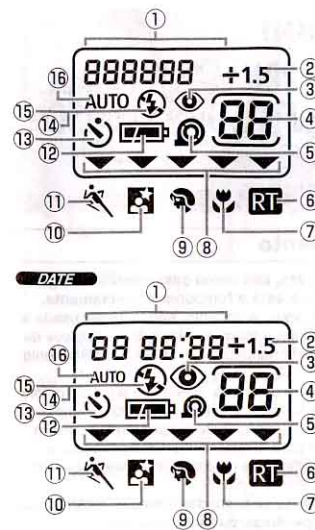

- ① Date **DATE** /
Custom Function number
- ② Manual exposure compensation
- ③ Red-eye reduction mark
- ④ Frame counter
- ⑤ Film mark
- ⑥ Real-time release
- ⑦ Close-up
- ⑧ Mode selection indicator
- ⑨ Portrait
- ⑩ Night portrait
- ⑪ Action
- ⑫ Battery level indicator
- ⑬ Self-timer
- ⑭ Flash ON (Fires for all shots)
- ⑮ Flash OFF (Never fires)
- ⑯ Autoflash

When "H" is displayed, remove the battery from the camera, wait until "H" is no longer displayed and then reload the battery.