

Canon

SURE SHOT

130u

SURE SHOT

130u **CAPTION**

PRIMA
SUPER 130
PRIMA
SUPER 130
CAPTION

E

F

S

P

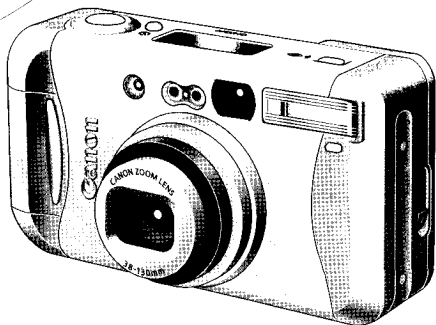

E Instructions

F Mode d'emploi

S Instrucciones

P Instruções

Handling Precautions

1. This camera is not resistant to water, and should not be used outdoors if it is raining or snowing. If it is accidentally dropped in water, contact an authorized Canon service facility. Keep the camera out of salt spray and excessive humidity. If used at the beach, clean it thoroughly afterward with a dry cloth.
2. Store the camera in a cool, dry, dust-free place. Be sure to keep the camera out of direct sunlight, and away from "hot spots" such as the trunk or rear window shelf of a car. Avoid places where mothballs are used, and use a desiccant in excessive humidity.
3. Do not attempt to disassemble the camera yourself, since there is high-voltage circuitry inside.
4. The battery may explode or cause burns if disassembled, recharged, shorted, exposed to high temperatures, or disposed of in a fire.
5. Use a blower brush to remove dust and sand from the lens and inside the camera. Do not apply any fluids to the lens or body. Take the camera to an authorized Canon service facility for a more thorough cleaning if necessary.
6. Film passing through X-ray examinations at an airport may be exposed and ruined even when loaded in the camera. Request a different method of inspection to avoid damage.
7. Color reproduction may be adversely affected if the film is left in the camera for a long time. Always develop exposed film promptly.

Convention

The following convention is used in these instructions:



Warnings you should observe when using the camera.



Additional information on using the camera.

Refer to the page number indicated in parenthesis, (→**), for further details.

This device complies with Part 15 of the FCC Rules. Operation is subject to the following two conditions: (1) This device may not cause harmful interference, and (2) this device must accept any interference received, including interference that may cause undesired operation.

Do not make any changes or modifications to the equipment unless otherwise specified in the instructions. If such changes or modifications should be made, you could be required to stop operation of the equipment.

This equipment has been tested and found to comply with the limits for a class B digital device, pursuant to part 15 of the FCC Rules. These limits are designed to provide reasonable protection against harmful interference in a residential installation. This equipment generates, uses and can radiate radio frequency energy and, if not installed and used in accordance with the instructions, may cause harmful interference to radio communications. However, there is no guarantee that interference will not occur in a particular installation. If this equipment does cause harmful interference to radio or television reception, which can be determined by turning the equipment off and on, the user is encouraged to try to correct the interference by one or more of the following measures:

- Reorient or relocate the receiving antenna.
- Increase the separation between the equipment and receiver.
- Consult the dealer or an experienced radio/TV technician for help.

This digital apparatus does not exceed the Class B limits for radio noise emissions from digital apparatus as set out in the interference-causing equipment standard entitled "Digital Apparatus", ICES-003 of the Industry Canada.

Cet appareil numérique respecte les limites de bruits radioélectriques applicables aux appareils numériques de Classe B prescrites dans la norme sur le matériel brouilleur: "Appareils Numériques", NMB-003 édictée par l'Industrie Canada.



The **CE** Mark is a Directive conformity mark of the European Community (EC)

Thank you for purchasing this Canon product.
Before taking pictures, please read these instructions carefully for a thorough understanding of how the camera operates.

Contents

Handling Precautions	2
Contents	4
Nomenclature	6

1 Basic Operations

Loading the Battery	10
Loading the Film	11
Removing the Film	12
Rewinding the Film in Mid-roll	12
Turning the Power On	13
Checking the Battery Level	13
Taking Pictures in Flash AUTO Mode	14
Shutter Button	15
Green/Orange Lamps	16
Using Focus Lock	17
Close-up Photography	18
Subjects Difficult to Autofocus	19
Holding the Camera	19
⌚ Shooting with Self-timer	20

2 Advanced Operations

⚡👁 Changing the Flash Mode	22
AUTO⚡ Flash AUTO	23
AUTO⚡👁 Flash AUTO with Red-eye Reduction	23
⚡ Flash ON (Fires for all shots)	23
👁 Flash OFF (Never fires)	23
+1.5👁-1.5👁 Flash OFF with Manual Exposure Compensation	24
⚡👁📷 Night Portrait (Slow-sync)	24



Using Red-eye Reduction Function Effectively	25
Setting the Custom Functions	26
 Shooting with Remote Control CAPTION	29
Replacing the Remote Control Battery	31
Imprinting the Date and Time CAPTION	32
Setting the Date and Time	32
Imprinting Captions CAPTION	34
Selecting the Language	35
3 Additional Information	
Troubleshooting	36
Specifications	38

Please note that these instructions are for both the model with the caption function and model without caption function. Information relevant only to the model with the caption function is marked with the **CAPTION** symbol.

The separately sold Remote Control RC-5 is available for use with the **CAPTION** model only.

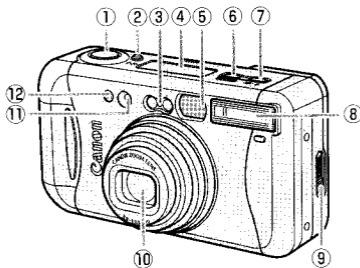
Nomenclature



- ① **Shutter button** (→14)
- ②  Self-timer/Remote control **CAPTION** button (→20, 28, 29)
- ③ AF* sensor/Metering window
- ④ LCD panel (→8, 9)
- ⑤ Viewfinder window
- ⑥ **MODE** Mode button (→32, 34) **CAPTION**
- ⑦  Flash mode button (→22, 28, 32-34)
- ⑧ Flash
- ⑨ Back cover release lever
Press this lever down to open the back cover.
- ⑩ Lens
- ⑪ Red-eye reduction/Self-timer lamp/AF*-assist beam emitter (→20, 23, 25, 30)
In dark places, the AF-assist beam emitter will light automatically.
- ⑫ Remote control sensor (→29) **CAPTION**

* AF is an abbreviation for Auto Focus.

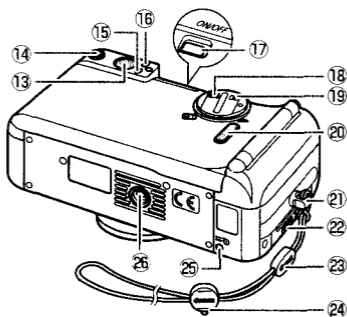

- ⑬ Viewfinder
- ⑭ Dioptic adjustment knob
Turn this knob to adjust the focus when you cannot see the viewfinder image clearly.
- ⑮ Orange lamp (→16)
- ⑯ Green lamp (→16)
- ⑰ **Main switch**
- ⑱ Zoom-out (wide-angle)/
 Selection **CAPTION** button (→14, 33, 35)
- ⑲ Zoom-in (telephoto)/Set **CAPTION** button
 (→14, 28, 32-35)
- ⑳ Film check window
- ㉑ Strap mount
- ㉒ Battery compartment cover (→10)
- ㉓ Strap
- ㉔ Strap buckle pin
Use this pin to push the button.
- ㉕ Mid-roll rewind button (→12)
- ㉖ Tripod socket

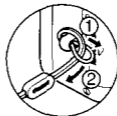

Attaching the Strap



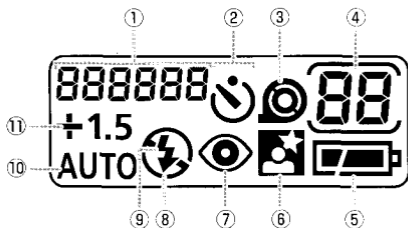

LCD Panel

(Normally, only the required information is displayed.)

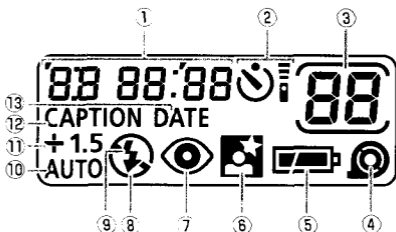

- ① Custom Function number
- ② Self-timer
- ③ Film mark
- ④ Frame counter
- ⑤ Battery level indicator (→13)
- ⑥ Night portrait (Slow-sync)
- ⑦ Red-eye reduction mark
- ⑧  Flash OFF (Never fires)
- ⑨  Flash ON (Fires for all shots)
- ⑩ Flash AUTO
- ⑪ Manual exposure compensation

CAPTION

- ① Date and time, caption number or Custom Function number
- ② Self-timer/Remote control
- ③ Frame counter
- ④ Film mark
- ⑤ Battery level indicator (→13)
- ⑥ Night portrait (Slow-sync)
- ⑦ Red-eye reduction mark
- ⑧  Flash OFF (Never fires)
- ⑨  Flash ON (Fires for all shots)
- ⑩ Flash AUTO
- ⑪ Manual exposure compensation
- ⑫ Caption imprinting
- ⑬ Date and time imprinting

Loading the Battery

Applicable Battery: One lithium battery (CR2)

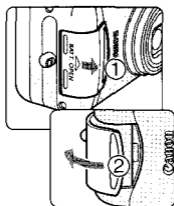

1 Open the battery cover.

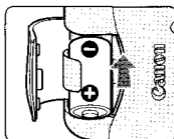

2 Load a new battery.

- Pull the tape to remove the battery.
 - Align the + – terminals correctly and insert the battery – end first.
- ➔  appears on the LCD panel.

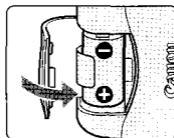

3 Close the battery cover.

- Push the cover closed until you hear a clicking sound.
- ➔ The date display "-- -- --" on the LCD panel blinks. Set the date and time. (→33) **CAPTION**

Loading the Film

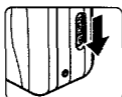

- 1 **Open the back cover and load the film.**

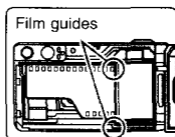
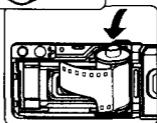

- 2 **Position the film correctly between the film guides.**

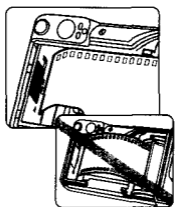

- 3 **Pull the film out to the  (film leader position indicator).**
- Make sure that there is no slack in the film when you pull it out.
 - If you pull out too much film, wind the film back into the cartridge slightly.

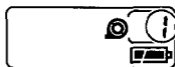

- 4 **Close the back cover.**
- ➔ The film automatically winds on to the first frame and "1" appears on the frame counter.

Loading the Film



- A film speed of ISO 400 is recommended.
- The film speed is set to ISO 25 when non-DX film is loaded. If the film does not have a DX-code, insert it into the film compartment, close the back cover and press the shutter button once or twice.
- For slide (reversal) film, you can use DX-coded film speeds of ISO 25, 50, 100, 200, 400, 800, 1600 and 3200.

Removing the Film

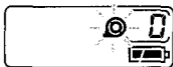

- The film rewinds automatically when it reaches the end. When  blinks, open the back cover and remove the film.

Rewinding the Film in Mid-roll

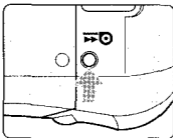

- Use the strap buckle pin on the strap buckle to press the  button on the bottom of the camera.
- Hold the button down until the film starts to rewind.

Turning the Power On

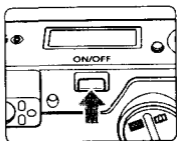





Press the main switch.

- ➔ Hold down the main switch for approximately 1 second. The lens is set to the wide-angle position.
- If you press the main switch again, the lens retracts, the lens cover closes and the camera switches off.
- When you switch the camera off, the display on the LCD panel does not disappear.

 Do not push on the lens with your hand.

Checking the Battery Level

Check that  appears on the LCD panel when you turn the power on.

- | | |
|--|---------------------------|
|  (lit) | The battery level OK. |
|  (lit) | Prepare new battery. |
|  (blinking) | Load a new battery. (→10) |

A new battery will generally provide enough charge to shoot approx. 17 rolls of 24-exposure film (based on Canon's Standard Test Method at normal temperature and with 50% flash use). At low temperatures ($-10^{\circ}\text{C}/14^{\circ}\text{F}$), the battery life is approximately one third of the normal figure.



 When you take consecutive shots using the flash, the battery level may drop off temporarily and prevent the LCD panel from displaying information correctly. If this occurs, switch the camera off and wait a few minutes before switching it back on again.

Taking Pictures in Flash AUTO Mode

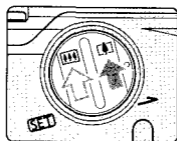
As long as the subject is in the wide area AF frame, the subject will be in focus. The flash also fires automatically in low light or backlit conditions.



Decide on the size of your subject.

- Pressing the  button zooms in on your subject while pressing the  button zooms out for a wide-angle shot.

Wide area AF frame

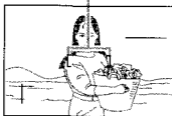

Set the focus.

- Position the wide area AF frame over your subject and lightly press the shutter button halfway down (press lightly).

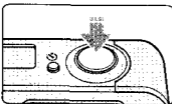

Green lamp

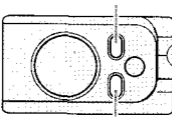

Orange lamp

- ➔ When the subject is in focus, the green lamp lights. (→16)
- ➔ When the flash fires automatically, the orange lamp lights. (→16)
- Keep the shutter button pressed halfway (Focus Lock).

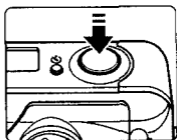



3 Compose the shot and take the picture.

- Press the shutter button fully (press firmly).
- Press the shutter button slowly and gently.
- ➔ The picture is taken.

 There is a very short delay between the shutter button being pressed and the shutter releasing. In general, you should continue to hold the camera still until you hear the sound of the film winding on, which indicates that the shot has been taken.

 If the lens is left extended in the telephoto position and is not used for 4 minutes, the lens is automatically retracted to wide-angle position.

 **Shutter Button**
The shutter button is a two-stage switch. Lightly press the shutter button halfway  (press lightly) to automatically determine focus and exposure. Press again fully  (press firmly) to take the picture.

Green/Orange Lamps

When you press the shutter button halfway down, the lamps light or blink to show whether the camera is ready to shoot.

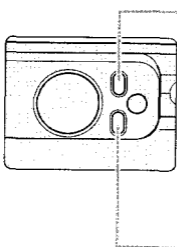

Green lamp

Lit: Camera ready to shoot
(subject in focus)

Blinking:

Too-close warning:
4 times per second

Focus warning:
16 times per second

Orange lamp

Lit: Flash ready

Blinking:

Camera shake warning
(in  mode)

- If a too-close warning is given, move back and press the shutter button again to check the green lamp is not blinking.
- If a focus warning is given, set the wide area AF frame on an area with contrast and try focusing again.
- If a camera shake warning is given, use a tripod to keep the camera steady.

Using Focus Lock

Use focus lock when you want to take a properly focused shot where the subject is not in the center of the picture.

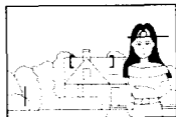

- Set the focus as described in step 2 "Taking Pictures in Flash AUTO Mode". Once your subject is in focus, keep the shutter button held down halfway as you recompose the shot with the subject to one side of the viewfinder. Then press the shutter button down fully.



Once you have set the focus, ensure that your subject does not move relative to the camera. If the distance to the subject changes, lock the focus again.



- Use of the CF4 Custom Function setting is recommended for such shots since it uses center-point AF to set the focus precisely. (→26)
- When you are shooting in remote control **CAPTION** mode, the focus remains locked for approximately 4 minutes after you press the shutter button halfway down, even if you release the shutter button. This gives you time to set the focus beforehand, compose the shot, and then take the picture.

Close-up Photography

When the shooting distance is closer than 1 m/3.3 ft., there is a difference between what you see in the viewfinder and the picture you actually take, and therefore the part of the picture outside the close-up frame will be cut off.

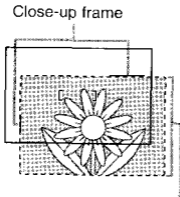

- Set the focus as described in step 2 "Taking Pictures in Flash AUTO Mode". Once your subject is in focus, keep the shutter button held down halfway as you recompose the shot so that the subject is inside the close-up frame.

Area actually photographed when the lens is in the telephoto position (inside dotted line).



Subjects Difficult to Autofocus

The green lamp blinks 16 times per second for subjects with the following characteristics that cannot be brought into focus.

If this happens, lock the focus on a subject that is approximately the same distance away as your subject, and recompose the shot.

Subjects difficult to autofocus:

- Subjects in scenes without much contrast, e.g. blue sky, or scenes of mainly one color
- Subjects in very dark places
- Subjects in extreme backlit situations or subjects which are extremely reflective, e.g. the body of a car which gives off a strong reflection
- Subjects in a photograph, some of which are close and some of which are in the distance, e.g. animals in a cage
- Subjects with a repetitive pattern, e.g. continuous windows in a building, etc.



Holding the Camera

- Grasp the camera firmly with both hands so that it does not move, and make sure that your hair, fingers or camera strap etc. do not come into contact with the lens, the AF sensor or the flash.

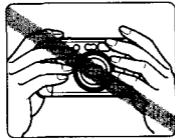

- Place the tip of your finger on the shutter button and holding the camera firmly, gently press down on the shutter button.





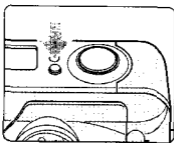

Shooting with Self-timer

The self-timer function allows you to take a picture when you are some distance from the camera.



Set the camera to self-timer mode.

- Press the  button.
- ➔  appears on the LCD panel.
- If you then press the  button again,  disappears and self-timer mode is cancelled.

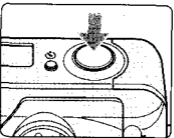
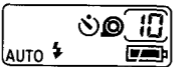

Compose the picture and press the shutter button.

- ➔ The red-eye reduction lamp blinks once a second and a countdown seconds remaining before the photo is taken is displayed on the LCD panel.
- ➔ The shutter is released after 10-sec. delay.
- To cancel the self-timer, press the  button again.



Do not stand directly in front of the camera when you press the shutter button as this will result in the picture being out of focus.



- Set the camera on a steady surface or use a tripod.
- Approx. 2 sec. before the shutter is released, the lamp blinks more rapidly. If the flash and the red-eye reduction function are used, the lamp stays lit for the last 2 seconds.
- Self-timer shots can be taken continuously for the 4 minutes that  is displayed.
- The remote control can be used. (→29) **CAPTION**

⚡👁 Changing the Flash Mode

You can fire the flash for every shot or cancel flash operation to suit the subject or location.

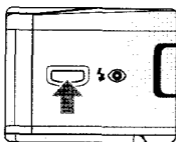

Select the flash mode.

- Press the ⚡👁 button to select the mode you want.
- ➔ Each time you press the ⚡👁 button, each of the modes is displayed and you can cycle through them in the following way:

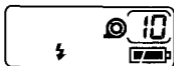



Flash Distance Range (with color print film)

Film speed		Wide-angle	Telephoto
ISO	100	0.6 to 3.1 m (2.0 to 10.2 ft.)	0.6 to 2.0 m (2.0 to 6.6 ft.)
	200	0.6 to 4.4 m (2.0 to 14.4 ft.)	0.6 to 2.8 m (2.0 to 9.2 ft.)
	400	0.6 to 6.2 m (2.0 to 20.4 ft.)	0.6 to 4.0 m (2.0 to 13.2 ft.)
	800	0.6 to 8.8 m (2.0 to 28.9 ft.)	0.6 to 5.6 m (2.0 to 18.4 ft.)

AUTO Flash AUTO

In dark places and in backlit conditions, the flash fires automatically.



You can select whether the autoflash mode initially set when you switch the camera on is **AUTO  ** or **AUTO **. Set the camera to the desired autoflash mode and then switch the camera OFF.

You can use the CF2 Custom Function setting to specify that whichever flash mode is active when you switch off the camera should be stored in the camera's memory. (→26)

AUTO Flash AUTO with Red-eye Reduction

In dark places, the flash automatically fires after the red-eye reduction lamp has lit.

You cannot shoot while the red-eye reduction lamp is on (for approximately 1 second). Keep pressing the shutter button until you hear the sound of the film winding on.

Flash ON (Fires for all shots)

In this mode, the flash fires regardless of the light conditions when the picture is taken. Use this setting for fill-in flash in daylight or to soften the shadows of the subject.

Flash OFF (Never fires)

In this mode, the flash does not fire regardless of how dark conditions are when the picture is taken. Use this mode for sunset shots, for places where flash use is prohibited, or for available-light photography.

There is automatic exposure compensation in backlit conditions but manual exposure compensation is also optional.

- The effects of exposure compensation may be *difficult to see on prints from color print film.*

+ 1.5 Exposure Compensation

You can use this setting to prevent your subject being too dark (underexposed) when the surroundings are extremely bright, such as at a ski-resort or in backlit conditions.







- 1.5 Exposure Compensation







You can use this setting to prevent your subject being too bright (overexposed) when the surroundings are extremely dark, such as on a spotlight stage.

This mode is effective for shooting subject with a night scene in the background.

Using a slow shutter speed, you can shoot faraway night scenes where the flash will not reach.

Even after the flash has fired, make sure the person in the photograph does not move until you hear the sound of the film winding on.

- The red-eye reduction function operates.
- In some conditions, **AUTO  ** may give better results. For this reason, it is best to take the picture in both **  ** and **AUTO  ** modes.

- 
 Because of the slow shutter speeds (up to 2 seconds) in dark places in , **+1.5** , **-1.5** , and    modes you must use a tripod to keep the camera steady.



Using Red-eye Reduction Function Effectively

When you use the flash to take photos of people in low light conditions, their eyes sometimes glow red in the photograph. This is referred to as the red-eye effect and is caused by the light of the flash being reflected off the retina of the eye.

When the red-eye reduction operates, the red-eye reduction lamp lights for approximately 1 second before the flash fires. This causes the subject's pupils to contract, minimizing the risk of red-eye.

- ① Take the picture from within 2 m/6.6 ft. of your subject.
 - ② Attract the subject's attention so that he or she looks at the camera.
- The effectiveness of the red-eye reduction function varies from person to person.
 - Set the lens to the wide-angle position.
 - Raise the available light level as much as possible.

Setting the Custom Functions



You can customize the functions listed below to suit your preferences or the photography conditions.

Custom Function No.		Setting	
Real-time Release	CF1	0	Off
		1	On
Flash Mode Memory	CF2	0	Off
		1	On
Automatic Film Rewind	CF3	0	On
		1	Off
Center-point AF	CF4	0	Off
		1	On
Continuous Shooting	CF5	0	Off
		1	On

Effects with the Function Set to 1

Releases the shutter immediately when you press the shutter button halfway down and then press it fully. Useful for situations where you need an instant camera response.

Stores the flash mode in memory immediately before the camera is switched off. Useful when you always want to set the flash to a particular mode. (→22)

Useful for situations where you do not want the sudden sound of the film rewinding. When you reach the end of the roll, the number on the frame counter and the  blink. Press the  button to start film rewinding. (→12)

A convenient function for when you want the subject of your shot to be off the center (→17) or when you want to focus definitely on your subject. The subject must be positioned in the center of the wide area AF frame.



While the shutter button is pressed, you can take approximately 0.8 continuous shots per second.

 If you press the shutter button all the way down in a single movement, real-time release does not operate.

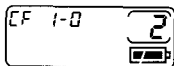
-  • The Custom Functions were all set to zero (0) at the factory setting.
- The Custom Function settings are retained even when you switch the camera off and on, replace the film, or replace the battery.



Set the camera to Custom Function setting mode.

- Switch the camera off.
- Hold down the  button and press the  button.

➔ "CF 1-0" appears on the LCD panel.

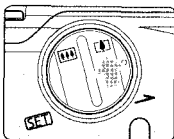

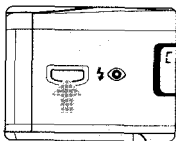
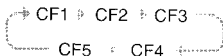
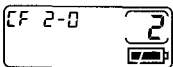

Select a function.

- The selected function changes each time you press the  button.



Set the function.

- Press the  button to change the setting display to 1 (function enabled).

Press the  button again to change the setting to 0 (function disabled).

- Turning the power on completes the settings.

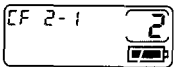



Shooting with Remote Control

CAPTION

You can use the remote control (RC-5) to release the shutter from up to 5 m /16.4 ft. in front of the camera.

Transmitter button



Transmitter



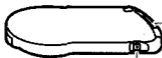

Battery holder

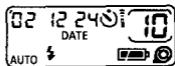
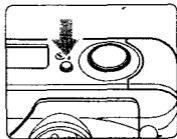

Battery holder release button



Set the camera to remote control mode.

- Press the  button.
- ➔  appears on the LCD panel.
- If you then press the  button again,  disappears and remote control mode is cancelled.

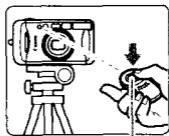

Transmitter button

Take the picture.

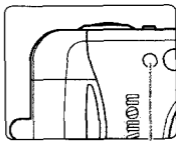

- Point the remote control towards the sensor on the camera and press the transmitter button.
- ➔ The shutter is released approximately 2 seconds later.



Remote control sensor

Remote control signal reception:

Reception of the remote control signal is indicated by the red-eye reduction lamp blinking 4 times a second (or remaining lit when red-eye reduction is used) and a countdown displayed on the LCD panel.

-  • Shooting with remote control may not be possible if the remote control sensor on the camera is exposed to sunlight or strong fluorescent light. If this happens, use the self-timer to take the picture or move the camera to another location.
 - The camera's remote control function may not operate correctly if the camera is close to a fluorescent light during signal reception. If this happens, move the camera away from the fluorescent light.
-
-  • Remote control shots can be taken for the 4 minutes that  is displayed.
 - *Set the camera on a steady surface or use a tripod.*

Replacing the Remote Control Battery

Replace the battery when you can no longer use the remote control to take pictures.

Battery: one CR2032 lithium battery

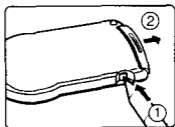

Pull out the battery holder.

- ① Use a pen or other pointed implement to push in the release button ② as you slide the battery holder out.

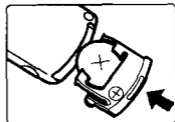

Load a new battery into the holder and fit the holder back into the remote control.

- Ensure that the + and - terminals are positioned correctly.

Imprinting the Date and Time **CAPTION**

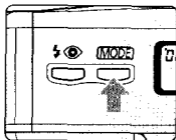

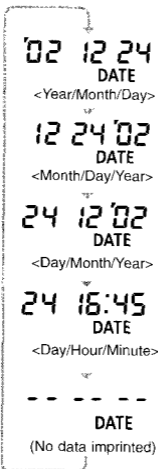

Select the Date mode.

- Press the **MODE** button until **DATE** appears on the LCD panel.



Select the date and time combination.

- The date and time combination changes each time you press the  button.
- Press the  button to return to ready-to-shoot mode.



Date/time etc. imprinted here.



The "02" in the year display indicates the last two digits in the year 2002.

Setting the Date and Time

When you replace the battery or travel to the different time zone, use the following procedure to set or adjust the date and time settings.

Setting the Date

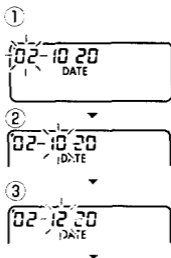

Setting the Time

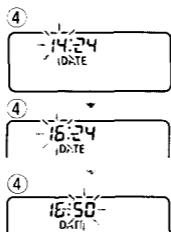

Select the Date mode.

Set the date and time.

- ① Press the button for more than 2 seconds for date/time set mode.
- ② Press the button to select the setting position (numbers blinking). Setting position cycles through in the order year-month-day-hour-minute-(:).
- ③ Press the button to set the number.
- ④ Repeat ② and ③ above to set all digits of the date and time. Pressing the button while ":" is blinking resets the seconds (:) setting to zero.
- ⑤ Press the button and once ":" stops blinking, date and time setting is completed. Press the button to return to ready-to-shoot mode.

Each time the button is pressed, the number increases by one. If kept pressed, the number increases continuously.

Imprinting Captions **CAPTION**

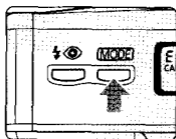

1 Select the Caption mode.

- Press the **MODE** button until **CAPTION** appears on the LCD panel.

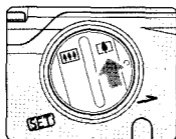

2 Select a caption.

- The caption number changes each time you press the **▲** button.
- Select **OFF** to cancel the caption.
- Press the **⚡👁** button to return to ready-to-shoot mode.

OFF (no data imprinted)

E-1 ♥ I LOVE YOU ♥

E-2 THANK YOU!

E-3 SEASON'S GREETING

E-4 HAPPY BIRTHDAY

E-5 CONGRATULATIONS



- If you want to imprint a caption only, set the date and time to "-- -- --" (→32).
- The caption is cleared after each photo is taken. To imprint the caption in successive photos, press the **▲** button for more than 2 seconds. **CAPTION**, on the LCD panel, blinks.

Selecting the Language

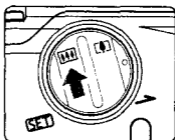

Select the Switch Language mode.

- Press the  button for more than 2 seconds.
- ➔ LANGUAGE blinks.

Language

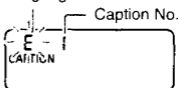

E (English)



F (French)





D (German)





ES (Spanish)

Select the language.

- Each time you press the  button, the language changes.
- Press the  button to set the language.

Troubleshooting

In case of problems, check the table below before taking your camera to be repaired.

Problem	Solution
 blinks on the LCD panel.	<ul style="list-style-type: none">• Replace the battery. (→10)
 is not displayed on the LCD panel.	<ul style="list-style-type: none">• Load the battery. (→10)• Reload the battery correctly. (→10)• Replace the battery. (→10)
The lens is not set.	<ul style="list-style-type: none">• Reload the battery correctly. (→10)
"0" blinks on the frame counter.	<ul style="list-style-type: none">• Reload the film correctly. (→11)
The shutter does not release.	<ul style="list-style-type: none">• Turn the power on. (→13)• Replace the battery. (→10)• Reload the film correctly. (→11)• Remove the film and load a new one. (→11, 12)• Hold the shutter button down until the shutter releases. (→15)• Change the flash mode. (→22)
The photographs are blurred.	<ul style="list-style-type: none">• Ensure that the AF sensor is not obscured by your hair, fingers etc. (→19)• Make sure that you do not stand directly in front of the camera when pressing the shutter button. (→21)• Press the shutter button slowly and gently. (→15)• Wipe the AF sensor clean. (→6)

Problem	Solution
I can't imprint the date/time or a caption on the last frame.	<ul style="list-style-type: none"> • Use 12-, 20-, 24- or 36-exposure film with the DX-code.
The date/time or caption imprinted on the photos is difficult to read.	<ul style="list-style-type: none"> • Compose your shots so that the background where the data is imprinted is dark. (→32)
"H" is displayed on the LCD panel.	<ul style="list-style-type: none"> • Remove the battery from the camera. When the "H" disappears from the LCD panel, load the battery again. (→10)

Specifications

Type: Fully-automatic 35 mm lens-shutter AF camera

Recording Medium: 35 mm film

Image Size: 24 × 36 mm

Lens: Canon zoom lens 38 – 130 mm f/5.6 – 12.5

Viewfinder: Real-image zoom viewfinder

Coverage: Approx. 84%

Dioptric Adjustment: –2.5 to +0.5 dpt.

Viewfinder Information: Picture frame, Wide area
AF frame, Close-up frame

Green lamp: Camera ready indicator/too-close
warning/focus warning

Orange lamp: Flash ready indicator/camera shake
warning

Focusing: *Passive 3-point AI AF**

Shooting Distance: 0.6 m (2.0 ft.) – infinity

Exposure Control Range:

Wide-angle: 1/560 sec., f/30 – 2 sec., f/5.6

Telephoto: 1/340 sec., f/39 – 2 sec., f/12.5

Film Speeds: DX-coded ISO 25 – 3200 set
automatically in full-stop increments

Exposure Compensation:

Automatic: In backlit conditions

Manual: +1.5 or –1.5-stops

Shutter: Electromagnetically controlled programmed
shutter/aperture

Self-timer: Shoot after 10 sec. delay.

Flash: Built-in zoom flash

Flash Mode:

1. Auto: Fires automatically in low light and backlit conditions.
2. Flash AUTO with red-eye reduction: Fires automatically in low light and backlit conditions.
3. Flash ON: Fires for all shots.
4. Flash OFF: Never fires.
5. Night portrait (slow-sync) with red-eye reduction: Fires for all shots.

Flash Distance Range: (with color print film)

ISO	Wide-angle	Telephoto
100	0.6 to 3.1 m (2.0 to 10.2 ft.)	0.6 to 2.0 m (2.0 to 6.6 ft.)
400	0.6 to 6.2 m (2.0 to 20.4 ft.)	0.6 to 4.0 m (2.0 to 13.2 ft.)

Flash Recycling Time: Approx. 6 seconds (with new battery)

Film Transport: Automatic, mid-roll rewind

Frame Counter: Counts up during film advance

Custom Functions: Five (real-time release, flash mode memory, disabling automatic film rewind, center-point AF, continuous shooting)

Power Source: One CR2 lithium battery

Battery Life: Approx. 17 rolls (24-ex. normal temperature with 50% flash use)

Dimensions (W × H × D): 105 × 58.5 × 45.8 mm/
4.1 × 2.3 × 1.8 in.

Weight: 210 g/7.4 oz. (without battery)

CAPTION

Automatic Date: Auto calendar to 2049.

Caption: 5 types of captions each in 4 languages

Remote Control: Remote Controller RC-5

- All the data is based on Canon's testing standards.
- Specifications and physical appearance are subject to change without notice.

* **AIAF (Dual AF) Function**

AIAF (Artificial Intelligence Auto-focus) has a wide focusing area and is a function for accurate focusing.

Canon

CANON INC. 30-2, Shimomaruko 3-chome, Ohta-ku, Tokyo 146-8501
Japan

U.S.A. **CANON U.S.A. INC.**
For all inquiries concerning this camera, call toll free in the U.S. 1-800-OK-CANON or write to: Customer Relations,
Canon U.S.A., Inc.
One Canon Plaza, Lake Success, N.Y. 11042-1198

CANADA **CANON CANADA INC. HEADQUARTERS**
6390 Dixie Road, Mississauga, Ontario L5T 1P7, Canada
CANON CANADA INC. MONTREAL BRANCH
5990, Côte-de-Liesse, Montréal Québec H4T 1V7, Canada
CANON CANADA INC. CALGARY OFFICE
2828, 16th Street, N.E. Calgary, Alberta T2E 7K7, Canada
For all inquiries concerning this camera, call toll free in Canada 1-800-OK-CANON

EUROPE, AFRICA & MIDDLE EAST **CANON EUROPA N.V.**
Bovenkerkerweg 59-61, P.O. Box 2262, 1180 EG Amstelveen
The Netherlands

CANON COMMUNICATION & IMAGE FRANCE S.A.
102, Avenue du Général de Gaulle 92257 La Garenne-
Colombes Cedex, France

CANON UK LTD.
Woodhatch Reigate Surrey RH2 8BF, United Kingdom

CANON DEUTSCHLAND GmbH
Europark Fichtenhain A10, 47807 Krefeld, Germany

CANON ITALIA S.p.A.
Palazzo L, Strada 6, 20089 Rozzano, Milanofiori, Milano, Italy

CANON Benelux N.V./S.A.
Bessenveldstraat 7, 1831 Diegem (Machelen), Belgium

CANON Schweiz AG
Geschäftsbereich Wiederverkauf, Industriestrasse 12, CH-8300
Dietlikon, Switzerland

CANON G. m. b. H.
Oberlaaerstrasse 233, 4th floor, 1100 Wien, Austria

CANON España, S. A.
C/Joaquín Costa, 41, 28002 Madrid, Spain

SEQUE Soc. Nac. de Equip., Lda.,
Praça da Alegria, 58, 2º, 1269-149 Lisboa, Portugal

CENTRAL & SOUTH AMERICA **CANON LATIN AMERICA, INC. DEPTO DE VENTAS**
703 Waterford Way Suite 400 Miami, FL 33126 U.S.A.
CANON LATIN AMERICA, INC. CENTRO DE SERVICIO Y REPARACION
Apartado 2019, Zona Libre de Colón, República de Panamá

ASIA **CANON HONGKONG CO., LTD.**
9/F, The Hong Kong Club Building, 3A Chater Road, Central,
Hong Kong
CANON SINGAPORE PTE. LTD.
79 Anson Road #09-01/06 Singapore 079906

OCEANIA **CANON AUSTRALIA PTY. LTD.**
1 Thomas Holt Drive, North Ryde, N.S.W. 2113, Australia
CANON NEW ZEALAND LTD.
Fred Thomas Drive, P.O. Box 33-336, Takapuna, Auckland,
New Zealand

JAPAN **CANON SALES CO., INC.**
12-15 Mita, 3-Chome, Minato-ku, Tokyo 108-8011, Japan