

**Canon**

**MACRO RING LITE  
MR-14EX**

**MACRO TWIN LITE  
MT-24EX**

**E**

## Thank you for purchasing a Canon product.

The Canon Macro Ring Lite MR-14EX/Macro Twin Lite MT-24EX are flash units for closeup photography. They have many high-end features such as the E-TTL (Evaluative-TTL) autoflash system.

The available features depend on the type of EOS camera you use with the MR-14EX/Macro Twin Lite MT-24EX. Refer to the tables below to confirm your EOS camera type and the MR-14EX/MT-24EX features which are compatible with your camera.

This instructions booklet has separate sections for Type-A and Type-B EOS cameras. Read Chapter 1 which applies to all cameras, then read the respective chapters which apply to your camera type.

Type-A Cameras	E-TTL	EOS-1V, 3, Elan 7E/30, Elan II/Elan II E/50/50 E, D30, 300/REBEL 2000, REBEL G/500, 3000N/66, IX, IX 7/IX Lite
Type-B Cameras	TTL	All EOS cameras other than the above.

### MR-14EX/MT-24EX Features Available with EOS Cameras

O: Available X: Not available

Features	With Type-A Cameras	With Type-B Cameras
E-TTL autoflash	O	X
TTL autoflash	O*	O
High-speed sync (FP flash)	O	X
FE lock	O	X
FEB (Flash exposure bracketing)	O	O
Wireless, multi-Speedlite E-TTL	O	X

\*With C.Fn-3-1.

#### Key to Symbols



The Caution symbol alerts you to actions to prevent flash photography problems.



The Note symbol gives additional information for basic operations.



The Light bulb symbol offers helpful tips for operating the Macro Ring Lite or for taking pictures.

Keep this Instructions booklet handy for future reference.

## About Macro Twin Lite MT-24EX Instructions

The only difference between Macro Ring Lite MR-14EX and Macro Twin Lite MT-24EX is the flash tube/heads and a few features. This instructions booklet centers on the MR-14EX and most of the instructions also apply to the MT-24EX. Instructions which apply only to the MT-24EX are in a separate chapter. If you have the MT-24EX, read up to page 5, then read pages 75 to 85. All other instructions (on pages 7 to 73) for the MT-24EX are the same as for the MR-14EX.

## How to Use this Booklet

If you have a Type-A camera, read pages 9 to 48 and 64 to 73. If you have a Type-B camera, read pages 9 to 20 and 49 to 73.

- The operation procedures assume that the camera and the MR-14EX/MT-24EX are already turned on. Before proceeding, be sure to turn on the main switch.
- The icons used in the text are the same ones found on the camera and the MR-14EX/MT-24EX's buttons and settings. For the name of the button or dial, see "Nomenclature" on pages 6 to 8 and 76.

Icons for the camera's shooting modes are as follows:

- : Full Auto
- : Shutter-priority AE
- : Program AE
- : Manual
- : Aperture-priority AE

- The (8) and (12) icons indicate that the function remains in effect for 8 sec. and 12 sec. respectively after the relevant button is released.
- Reference page numbers are indicated in parentheses as follows: (→p.■)
- The icon brings attention to a simple description of the respective Custom Function. For a detailed explanation of the Custom Function, see "Custom Functions" on pages 64 and 83. The instructions in this booklet assume that the standard Custom Functions settings are in effect.

# Contents

About Macro Twin Lite MT-24EX Instructions .....	3
How to Use this Booklet .....	3
Nomenclature .....	6

## 1 Before You Start (Type-A Cameras, Type-B Cameras) ... 9

Installing Batteries .....	10
External Power Sources .....	12
Attaching the Control Unit to the Camera .....	13
Attaching the Flash Ring .....	14
Main Switch .....	15
Pilot Lamp and Test Firing .....	16
Flash Exposure Confirmation .....	16
Flash Range .....	17
Flash Mode .....	19
Setting the Film Speed .....	19
LCD Panel Illumination .....	19
Focusing Lamp .....	20
Resetting to the Default Settings .....	20

## 2 Basic Flash Photography (Type-A Cameras) ..... 21

Using Flash with the Camera's Shooting Modes .....	22
--	----

## 3 Advanced Flash Photography (Type-A Cameras) ..... 25

☉ ☉: Selecting the Flash Tube .....	26
Modeling Flash .....	29
FE Lock .....	30
☉☉ Flash Exposure Compensation .....	32
☉☉ FEB (Flash Exposure Bracketing) .....	34
☉ High-Speed Sync (FP Flash) .....	36
M Manual Flash Mode .....	38
☉☉ Second-Curtain Synchronization .....	40

## 4 Wireless Flash Photography (Type-A Cameras) ..... 41

Setting Up a Wireless Flash System .....	42
Using the Wireless Flash System .....	45

## 5 Basic Flash Photography (Type-B Cameras) ..... 49

Using Flash with the Camera's Shooting Modes .....	50
--	----

## 6 Advanced Flash Photography (Type-B Cameras) ..... 53

☉ ☉: Selecting the Flash Tube .....	54
☉☉ Flash Exposure Compensation .....	56
☉☉ FEB (Flash Exposure Bracketing) .....	58
M Manual Flash Mode .....	60
☉☉ Second-Curtain Synchronization .....	62
Wireless Manual Flash .....	63
☉☉ Custom Functions .....	64
MR-14EX/MT-24EX System .....	66
Troubleshooting Guide .....	68
Specifications .....	69
Feature Availability Table .....	72

## 7 Macro Twin Lite MT-24EX Features ..... 75

Nomenclature .....	76
Attaching the Flash Heads .....	77
Flash Head Movements .....	80
Flash Distance Range .....	83
☉☉ Custom Functions .....	83
Major Specifications .....	84

# Nomenclature

## Flash Ring

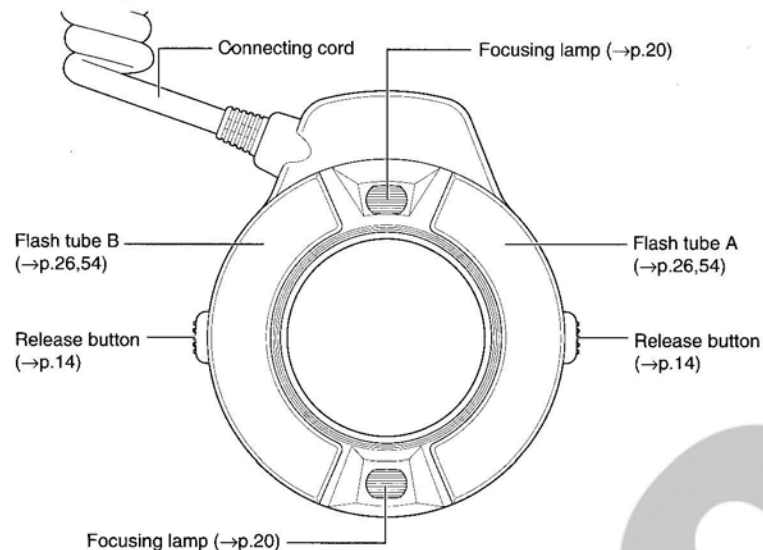

## Flash Ring Rear

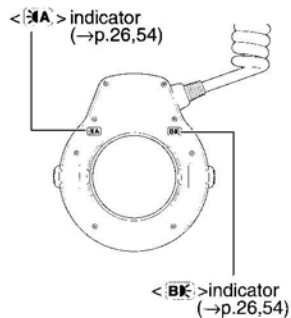

## Side Panel

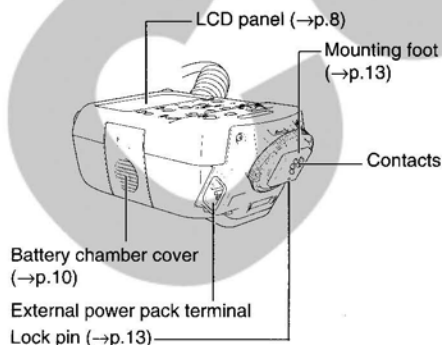

# Nomenclature

## Control Unit

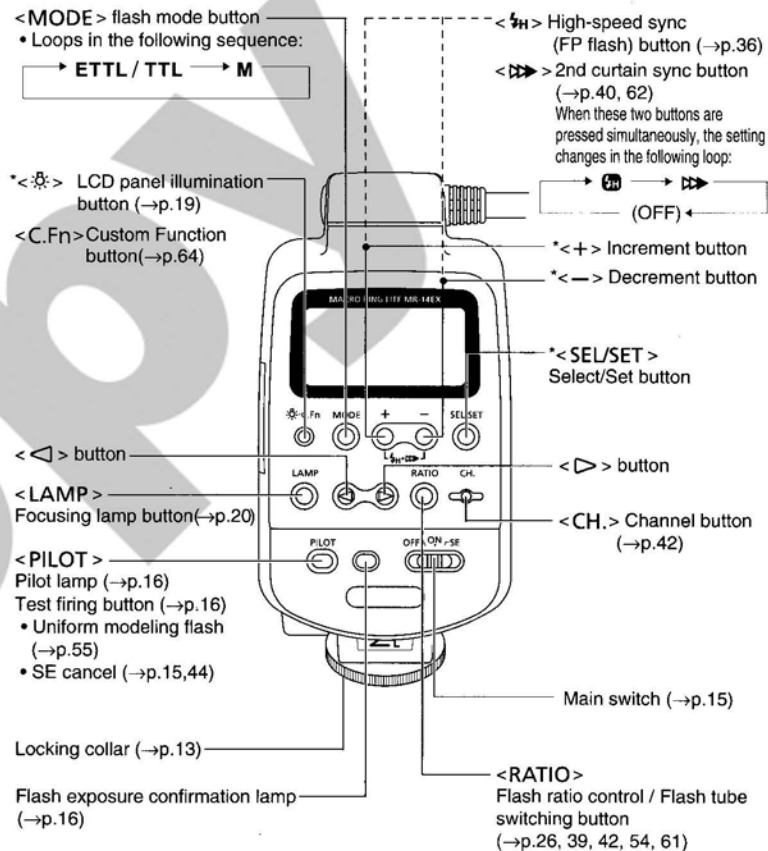

ⓘ Asterisked items have functions which remain effective for (⊙8) after the button is released. The <Fn> button illuminates the LCD panel for (⊙12).

LCD Panel

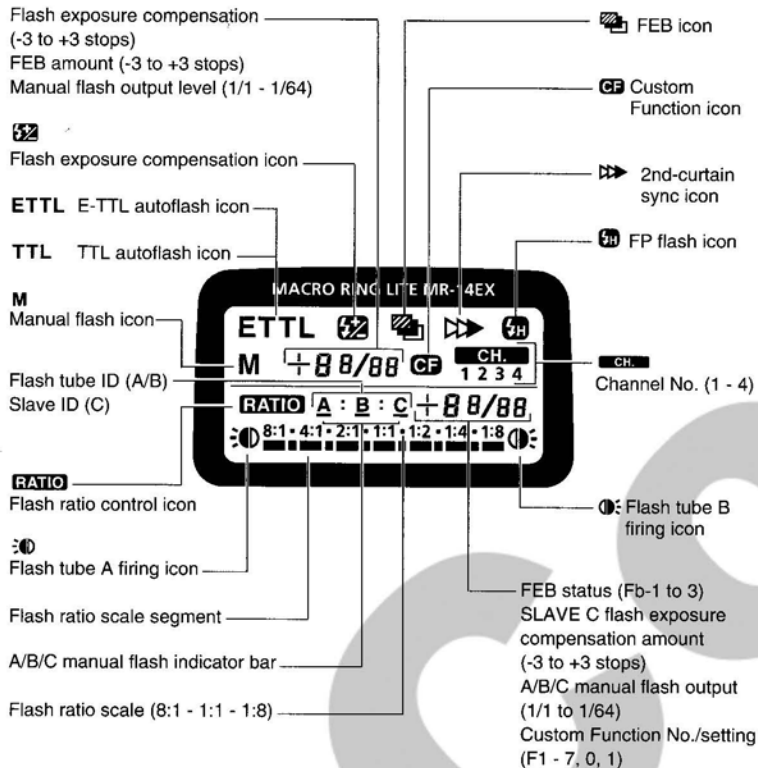

- The LCD panel is shown with all the icons and indications displayed. The items actually displayed differ depending on the flash settings.

Learn how to prepare the Macro Ring Lite MR-14EX for actual use.

Before You Start

## Installing Batteries

Macro Ring Lite MR-14EX requires one of the following two types of batteries:

- (1) Four size-AA alkaline batteries
- (2) Four size-AA nickel-hydride batteries

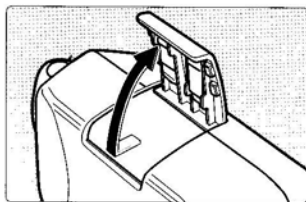

- 1** Slide the battery compartment cover as shown by the arrow and flip it up.

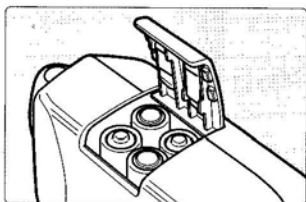

- 2** Insert the batteries.
- Make sure the + and – battery contacts are properly oriented as shown in the battery chamber.

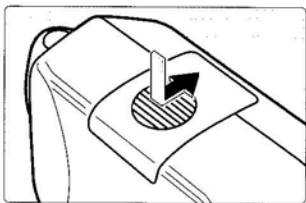

- 3** Close the battery chamber cover as shown in the diagram.



- Use four new batteries of the same type. When replacing batteries, replace all four batteries at one time.
- Size-AA lithium batteries can also be used.
- Although non-alkaline, manganese batteries may also be used, the number of flashes will be less.
- Remove the batteries when the Macro Ring Lite MR-14EX will not be used for an extended period.
- In low temperatures, take two sets of batteries and keep one set warm in a pocket, etc., and use the batteries alternately.



- To prevent faulty connections, make sure the battery contacts are clean. If necessary, use a clean cloth to wipe the battery contacts.
- In the case of size-AA nickel-hydride and size-AA lithium batteries, the shape of the contacts is not standardized. Be sure that the batteries are compatible with the flash unit before buying.

### Recycling Time and Flash Count

(Applicable to both or only one flash tube firing)

Battery Type	Recycling Time	Flash Count
Size-AA alkaline batteries	Approx. 0.1-7 sec.	Approx. 120 to 800

- The minimum recycling time applies in the E-TTL or TTL mode while the maximum recycling time applies in the manual or full-output (1/1) mode.
- The minimum flash count applies in the manual or full-output (1/1) mode while the maximum flash count applies in the E-TTL or TTL mode.
- The above specifications are based on Canon's testing standards.
- Using size-AA nickel-hydride batteries will yield only 60 percent of the flashes (1600 mAh at full output) obtainable with size-AA alkaline batteries.

## External Power Sources

Macro Ring Lite MR-14EX can use either of the following two external power packs. For details on the power pack, refer to the Instructions of the respective power pack.

- (1) Compact Battery Pack CP-E2  
Uses six size-AA alkaline, nickel-hydride, or lithium batteries.
- (2) Transistor Pack E  
Uses Battery Magazine TP (six size-C alkaline batteries) or Ni-Cd Pack TP.

## Recycling Time and Flash Count

(Applicable to both or only one flash tube firing)

Power Source		Recycling Time (sec.)	Flash Count
Internal Power Sources	Size-AA alkaline batteries	Approx. 0.1-7	Approx. 120-800
External Power Sources	Compact Battery Pack CP-E2 (w/alkaline batteries)	Approx. 0.1-4	Approx. 400-2500
	Transistor Pack E (w/alkaline batteries)	Approx. 0.1-4	Approx. 400-2500
	Transistor Pack E (w/Ni-Cd Pack TP)	Approx. 0.1-3	Approx. 330-2000

- Even when an external power source is used, batteries must still be installed in the MR-14EX to power its internal circuitry.
- The MR-14EX uses both the internal and external power sources to recycle the flash. Therefore, the internal power source may become exhausted sooner than the external power source. For prolonged flash photography, keep a spare set of size-AA batteries handy for the internal power source.

## Attaching the Control Unit to the Camera

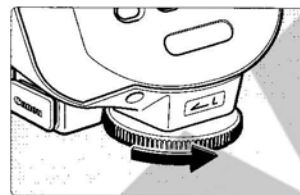

Loosen the locking collar by turning it as shown by the arrow.

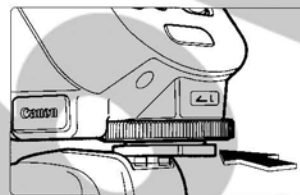

Slip the Control Unit's mounting foot into the camera's hot shoe all the way.

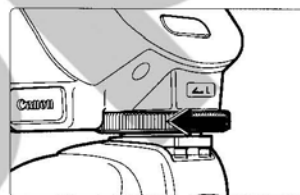

Turn the locking collar as shown by the arrow and tighten.

- The mounting foot's locking pin will also extend into the hot shoe.
- To detach the Control Unit, turn the locking collar in the opposite direction until it stops. (The locking pin retracts into the mounting foot.) Then slip it off the hot shoe.

## Attaching the Flash Ring

The Macro Ring Lite MR-14EX can be attached directly to the following lenses: EF 50mm f/2.5 COMPACT MACRO, EF 100mm f/2.8 MACRO USM, EF 100mm f/2.8 MACRO, and MP-E 65mm f/2.8 1-5x lenses. To attach it to the EF 180mm f/3.5L MACRO USM, the Macro Lite Adapter 72C (sold separately) is required.

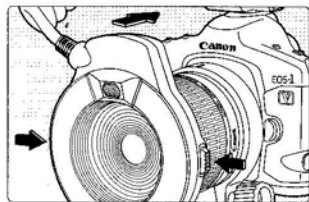

### 1 Press the release buttons on both sides of the flash ring.

- Keep pressing both release buttons.

### 2 Attach the flash ring to the Macro Ring Lite mount on the front of the lens.

- Let go of the release buttons and make sure the flash ring is securely attached to the front of the lens.
- The flash ring can rotate 360 degrees.
- To detach the flash ring, follow this procedure in reverse.

## Attaching the Macro Lite Adapter 72C

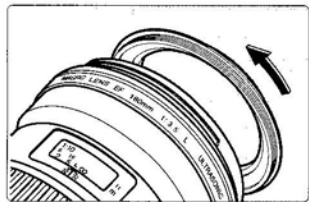

Screw on the Macro Lite Adapter 72C onto the front of the EF 180mm f/3.5L MACRO USM lens.

- A lens hood cannot be attached while the Macro Ring Lite MR-14EX is attached to the lens.
- The MR-14EX cannot be attached to the EF 100mm f/2.8 MACRO USM or to the MP-E 65mm f/2.8 1-5x while a filter is attached to the lens. Remove any filter before attaching the MR-14EX.

## Main Switch

The main switch has three settings as shown below.

OFF  $\rightarrow$  ON  $\rightarrow$  SE



Turns off the power.

OFF  $\rightarrow$  ON  $\rightarrow$  SE



Turns on the power.

OFF  $\rightarrow$  ON  $\rightarrow$  SE



Turns on the power and enables the SE mode.

- To save battery power, the SE (Save Energy) mode turns off the Macro Ring Lite automatically after 90 sec. of non-use.
- To cancel the SE mode, press the test firing button.



### Memory feature

The Macro Ring Lite's current flash mode, flash exposure compensation setting, etc., are retained in memory even after it is turned off. When the Macro Ring Lite is turned on again, all the settings will still be in effect. When you replace the batteries, you can retain the settings if you install new batteries within 90 sec.



## Pilot Lamp and Test Firing

This tests whether the Macro Ring Lite can fire a flash.

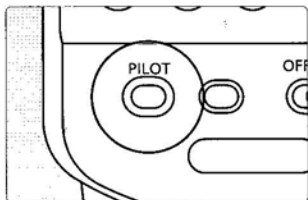

1

### Check the Pilot lamp.

- When the flash is ready, the Pilot lamp will light.

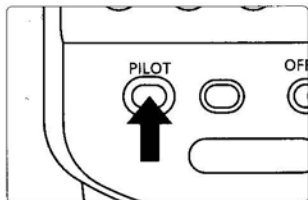

2

### Press the Pilot lamp (test firing button).

- A flash will fire.
- The Pilot lamp is also a test firing button.



- A test flash cannot be fired after you press the camera's shutter button halfway and the camera metering is still active for ( 6 ).
- If the Macro Ring Lite is in the SE mode, pressing the test firing button turns on the Macro Ring Lite.

## Flash Exposure Confirmation

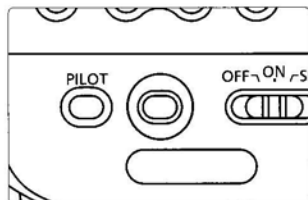

When a correct flash exposure has been obtained, the flash exposure confirmation lamp lights in yellow-green for 3 sec. immediately after the flash fires.

## Flash Range

This is a general guide to the MR-14EX's effective flash range.

### With EF 50mm f/2.5 COMPACT MACRO

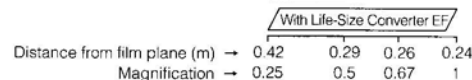
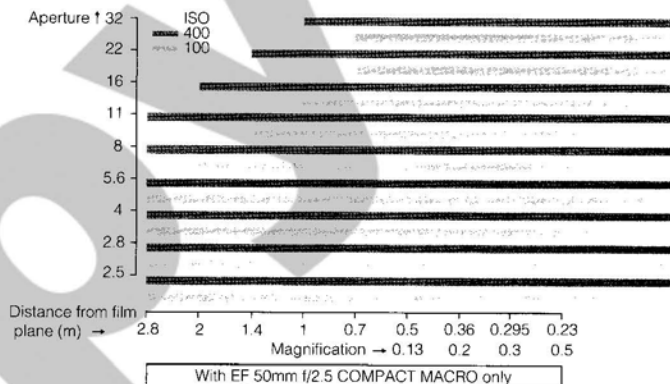

### With EF 100mm f/2.8 MACRO USM / EF 100mm f/2.8 MACRO

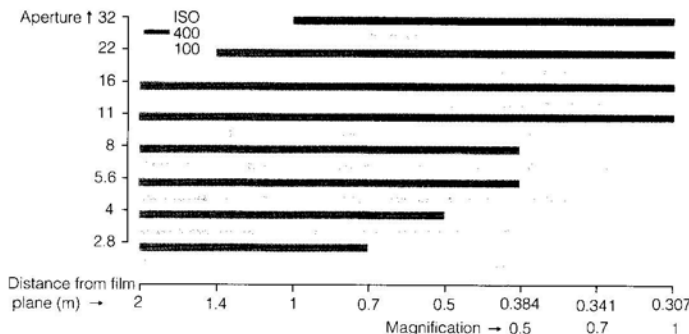

## Flash Range

### With EF 180mm f/3.5L MACRO USM

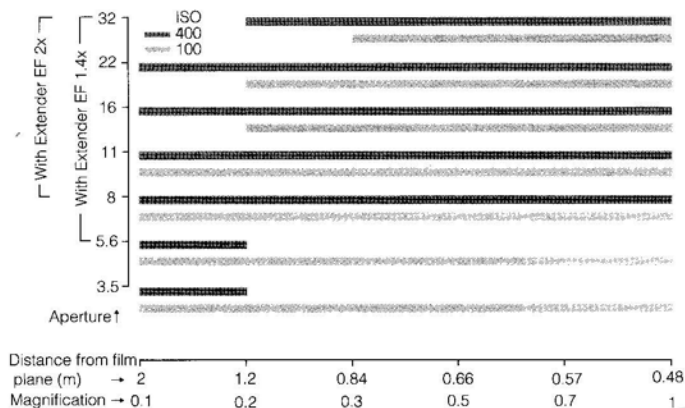

### With MP-E 65mm f/2.8 1-5x

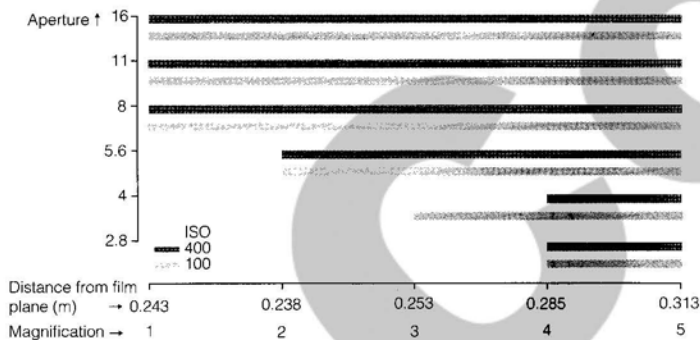

## Flash Mode

Press the <MODE> button to select the E-TTL (or TTL) autoflash mode or manual flash mode.

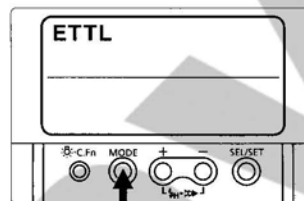

Press the <MODE> button.

Pressing the button toggles the flash mode between ETTL (TTL) and M

→ ETTL (TTL) → M

With a Type-A camera, ETTL autoflash will be set. With a Type-B camera, TTL autoflash will be set.

## Setting the Film Speed

The film speed is set automatically according to the film speed set with the camera.

## LCD Panel Illumination

In low-light, you can illuminate the LCD panel for (⌚12).

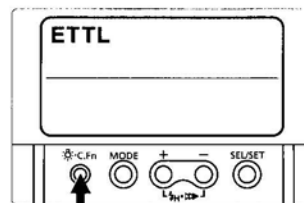

Press the <⌚> button to illuminate the LCD panel.

- The LCD panel is illuminated for 12 sec.
- To turn off the illumination, press the <⌚> button again.
- Pressing any button other than the <PILOT> and <⌚> buttons will extend the illumination time beyond (⌚12).

## Focusing Lamp

In low-light or when the viewfinder image gets darker at high magnifications, it becomes difficult to achieve correct focus. In such cases, the focusing lamp can assist with focusing.

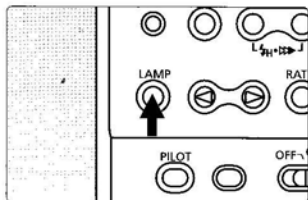

- 1 Press the <LAMP>button.**
  - The focusing lamps on the top and bottom of the flash ring will light for about 20 sec.

- 2 Focus the subject.**

- 3 Press the <LAMP>button.**
  - To turn off the focusing lamps, press the <LAMP> button again.

## Resetting to the Default Settings

When the Macro Ring Lite is attached to an EOS camera equipped with a <CLEAR> button, pressing the <CLEAR> button resets the Macro Ring Lite's settings (except the Custom Functions) to its default settings

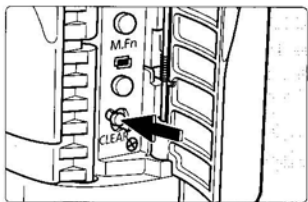

### Press the camera's <CLEAR> button.

- The default settings are as follows:
  - E-TTL autoflash\*
  - Left and right flash tubes firing at the same output
  - Normal flash

\*With the EOS-1N and EOS-1, TTL autoflash will be set.

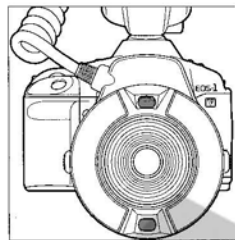

When the MR-14EX is mounted on a Type-A camera such as the EOS-1V, taking flash pictures with E-TTL autoflash is just as easy as normal autoexposure (AE) pictures. As with evaluative metering, the E-TTL autoflash system uses a multi-zone metering sensor which enables highly precise flash exposure control. A preflash is fired for evaluative flash metering and the reading is stored in memory. The result is a flash picture with excellent balance between the flash exposure and ambient light.

## For Type-A Cameras Basic Flash Photography

- In macro photography, setting the correct exposure greatly depends on the subject. It would be best to bracket the exposure even for the same subject. (→p.32)

- This section uses the EOS-1 V as the Type-A camera.
- Before proceeding, first turn on the Main Switch on the EOS-1 V and MR-14EX.
- For EOS-1 V operations, refer to the EOS-1 V Instructions booklet.

## Using Flash with the Camera's Shooting Modes

For E-TTL autoflash shots, just set the camera's shooting mode to **P** (Program AE), **A<sub>v</sub>** (aperture-priority AE), or **M** (Manual exposure). For serious closeup flash photography, **A<sub>v</sub>** or **M** is recommended.

\* When you press the shutter button completely, a preflash is fired immediately before the picture is taken. The preflash is used to obtain the subject's reflected-light reading for calculating the optimum output of the main flash.

### P: Program AE Mode and E-TTL Autoflash

Set the camera's shooting mode to **P**, and the camera will set the flash aperture and shutter speed automatically. You can thereby concentrate on the subject.

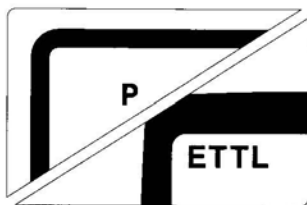

1 Set the camera's shooting mode to **P**.

2 Set the MR-14EX's flash mode to **ETTL**.

3 **Focus and take the picture**

- Check that the  icon (flash ready) is displayed in the viewfinder before taking the picture.



- If the camera has the Full Auto mode  and it is set to this mode, the shutter speed and aperture will be set in the same way as with the **P** mode (Program AE).
- If the **DEP** mode (depth-of-field AE) is used with the MR-14EX, it will be the same as using the **P** mode.
- If the **T<sub>v</sub>** mode (shutter speed-priority AE) is used to set the shutter speed, the camera will set the flash aperture automatically. Since you cannot set the desired aperture in this mode, it is not recommended for closeup flash photography.

### A<sub>v</sub>: Aperture-Priority AE and E-TTL Autoflash

This mode is effective for controlling the depth of field in your flash pictures. You can also obtain a correct exposure for both the subject and background. You set the aperture and the camera sets the shutter speed automatically for the correct exposure of the background. The E-TTL autoflash system obtains the correct flash exposure based on the aperture you set.



1 Set the camera's shooting mode to **A<sub>v</sub>** and set the aperture.



2 Set the MR-14EX's flash mode to **ETTL**.



3 **Focus and take the picture.**

- Check that the  icon (flash ready) is displayed in the viewfinder before taking the picture.

- In low-light conditions, the shutter speed will be slow. Use a tripod.
- If you take the picture while the focusing lamp is on, underexposure may result. Wait until the focusing lamp turns off, then take the picture.

- If the top shutter speed display blinks, the background will be overexposed. Or if the slowest shutter speed (30") display blinks, the background will be underexposed. In such cases, change the aperture until the shutter speed display stops blinking.

## M: Manual Exposure and E-TTL Autoflash

In this mode, you set both the shutter speed and aperture. The E-TTL autoflash system controls the flash exposure based on the aperture you set. The proper exposure of the background is set with both the aperture and shutter speed.

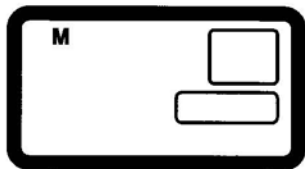

### 1 Set the camera's shooting mode to M and set the aperture and shutter speed.

- Set the desired aperture and the shutter speed anywhere from 30 sec. to the top sync speed. You can also use buLb.

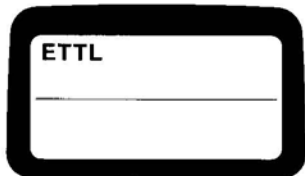

### 2 Set the MR-14EX's flash mode to ETTL.

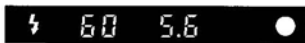

### 3 Focus and take the picture.

- Check that the ⚡ icon (flash ready) is displayed in the viewfinder before taking the picture.

With the EOS-1 V and EOS-3, you can check the background exposure level by looking at the exposure level indicator in the viewfinder.

The MR-14EX's advanced features are explained in this chapter. They are as follows:

- Selecting the Flash Tube (→p.26)
- Modeling Flash (→p.29)
- FE Lock (→p.30)
- Flash Exposure Compensation (→p.32)
- FEB (Flash Exposure Bracketing) (→p.34)
- High-Speed Sync (FP flash) (→p.36)
- Manual Flash Mode (→p.38)
- Second-Curtain Synchronization (→p.40)

## For Type-A Cameras Advanced Flash Photography

- This section uses the EOS-1 V as the Type-A camera.
- Before proceeding, first turn on the Main Switch on the EOS-1 V and MR-14EX.
- For EOS-1 V operations, refer to the EOS-1 V Instructions booklet.

## ☺☹ Selecting the Flash Tube

By firing only one of the flash tubes or by setting a flash ratio for flash tubes A and B, you can create shadows and sculptural lighting effects. You can set the flash ratio from 1:8 to 1:1 to 8:1 (13 levels) in 1/2-stop increments.

- \* The **ETTL** flash mode must be set.
- \* Since the flash exposure is controlled automatically, you need not bother with any flash metering calculations.
- \* If you set the flash mode to **M**, see page 39.

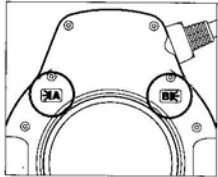

The flash tube ID is "A" for the left one and "B" for the right one when you look at the rear of the flash ring.

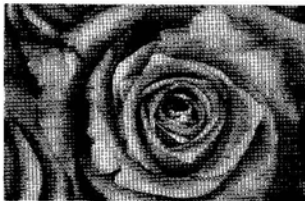

A:B=1:1



A:B=4:1

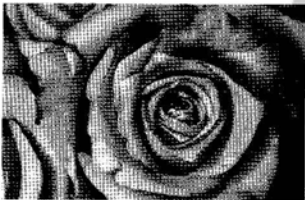

Only flash tube A fired.



Only flash tube B fired.

## Firing Both Flash Tubes

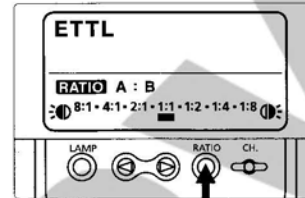

Press the **<RATIO>** button and select **RATIO A : B**.

Each time you press the button, the selection will change in the following loop:



The flash ratio and the ☺☹ and ☹☺ icons will be displayed.

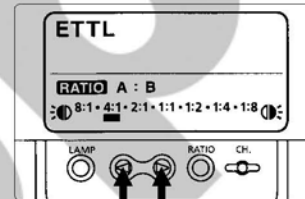

Press the **<<>** or **<>>** button to move the bar **■** left or right to set the respective **A:B** flash ratio.

You can set the flash ratio from 1:8 to 1:1 to 8:1

Focus and take the picture.

Check that the ⚡ icon (flash ready) is displayed in the viewfinder before taking the picture.

The flash ratio for the short bars ■ on the flash ratio scale is as shown below.

**8:1 • 4:1 • 2:1 • 1:1 • 1:2 • 1:4 • 1:8**

(5.6:1) (2.8:1) (1.4:1) (1:1.4) (1:2.8) (1:5.6)

- In exposure stops, the flash ratio range is equivalent to 3:1 to 1:1 to 1:3.
- Even if the **RATIO** icon is not displayed, both flash tubes will fire. The flash output will be the same for both flash tubes.
- You can also use the **<SEL/SET>** button and **<+>** **<->** buttons to set the flash ratio for flash tubes A and B.

## Firing Only One Flash Tube

Follow the same procedure as for "Firing Both Flash Tubes" except for step 2. For step 2, follow the operation below.

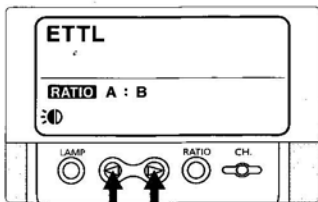

Press the <<> or <>> button to move the bar ■ all the way to the left or right to the ♂ or ♀ icon.

- ♂: Fires only flash tube A **XA**
- ♀: Fires only flash tube B **XB**

-  The flash ratio can be adjusted only with the EOS-1V, 3, Elan 7E/30 and D30 cameras. With other Type-A cameras, the flash ratio will be fixed at 1:1 for both flash heads. You can also fire only one of the flash heads.
- Pressing the <RATIO> button will not display the **RATIO** icon and flash ratio. Selecting ♂ or ♀ will fire only one of the flash tubes. When both ♂ ♀ icons are displayed, both flash tubes will fire at the same output.

## Modeling Flash

Firing a modeling flash enables you to check the lighting and shadow effects before you take the picture.

\* The modeling flash is fired at 70 Hz for 1 sec.

### Modeling Flash with Flash Ratio (w/EOS-1V, 3, Elan 7E/30 or D30)

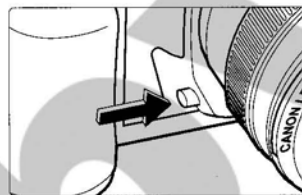

Press the depth-of-field preview button.

- The modeling flash will fire according to the flash ratio that has been set.

-  To prevent overheating and deterioration of the flash tubes, do not fire the modeling flash more than 10 times in succession. After 10 times, allow the MR-14EX to cool for at least 10 minutes.

- CF** C.Fn-6 can disable the modeling flash with flash ratio. (→p.64)
- CF** C.Fn-4 can have the modeling flash fire at a uniform output with all Type-A cameras. (→p.64)

## FE Lock

With Type-A cameras, you can set FE (flash exposure) lock. This is the flash version of AE lock. With FE lock, you use spot metering to obtain the correct flash exposure reading for a specific area of the subject.

\* The flash mode must be set to **ETTL**.

**1** Select a shooting mode with the camera.

**2** Focus the subject.

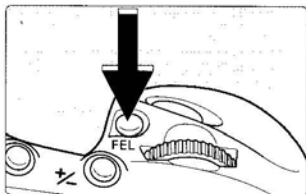

**3** Aim the viewfinder's spot metering circle over the area of the subject to be metered. Then press the <FEL> button on the camera. FE lock remains in effect for 16 sec.

- ▶ The MR-14EX fires a preflash to obtain an exposure reading. The reading is retained temporarily in memory.
- ▶ FEL is displayed on the viewfinder bottom for 0.5 sec.
- You can obtain a new FE lock reading by pressing the <FEL> button again.
- To cancel FE lock, wait until 16 sec. elapse or press the <MODE>, <AF>, or <Ⓜ> button on the camera.

**4** Focus the subject.



**5** Take the picture

- In the viewfinder, check the flash exposure level indicator and check that the ⚡ icon is displayed.



With FE lock

The flash exposure was locked on the leaf where the butterfly was resting. After recomposing, the picture was taken. Since the butterfly's white wings and the dark background did not affect the flash exposure reading, the butterfly was exposed correctly.

- ⓘ • If the flash will be insufficient, ⚡ will blink. Use a larger aperture (smaller f-number) and try FE lock again
- FE lock cannot be used when the MR-14EX is set to the M (Manual) flash mode. With the EOS Elan II/Elan IIE/50/50E and EOS IX, the ⚡ icon blinks in the viewfinder to warn that FE lock cannot be used.

- ⓘ • The preflash for FE lock fires at about 1/32 output.
- With Type-A cameras other than the EOS-1 V and EOS-3, the AE lock button functions as an FE lock button when the MR-14EX is flash-ready.
- If the subject is smaller than the spot metering circle, using FE lock might not make any difference.



## Flash Exposure Compensation

With the MR-14EX, you can set the flash exposure compensation up to  $\pm 3$  stops in 1/3-stop increments (or 1/2-stop increments with some cameras). In tandem, you can also set exposure compensation with the camera to control the background's exposure level in the flash picture.

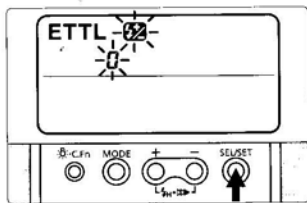

### 1 Press the <SEL/SET> button and select $\pm$ .

▶ Pressing the button changes the blinking selection in the following loop:

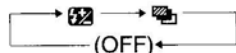

▶ The  $\pm$  icon and flash exposure compensation amount will blink.

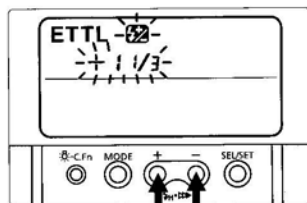

### 2 Press the <+> or <-> button to set the desired flash exposure compensation amount.

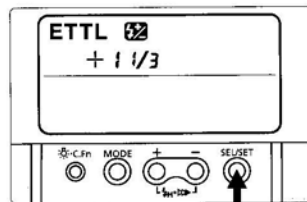

### 3 Press the <SEL/SET> button.

▶ The  $\pm$  icon and flash exposure compensation amount will be displayed.

### 4 Focus the subject.

▶ When you press the shutter button halfway, the flash exposure compensation amount will be displayed on the viewfinder's right and the  $\pm$  icon will be displayed on the viewfinder bottom.



### 5 Take the picture

▶ Check that the  $\pm$  and  $\pm$  icons are displayed in the viewfinder before taking the picture.



- Flash exposure compensation set with the MR-14EX overrides any flash exposure compensation set with the camera.
- In step 3, instead of pressing the <SEL/SET> button, you can press the shutter button halfway to set the flash exposure compensation.
- If you take a picture during step 2 (while the flash exposure compensation amount is still blinking), the flash exposure compensation will take effect in the picture according to the blinking amount.
- If the subject is small and the background is dark or far away, flash exposure compensation may not obtain the desired result. In such a case, use the manual flash mode. (→p.38)



### How exposure compensation affects the flash picture

	Effect
E-TTL flash exposure compensation	Changes the flash exposure of the subject.
AE exposure compensation	Changes the background exposure.
Changing the ISO film speed setting	Changes both the flash (subject) exposure and background exposure.

## FEB (Flash Exposure Bracketing)

You can change the flash exposure level automatically while keeping the background exposure level the same. Three flash shots can be bracketed up to  $\pm 3$  stops in 1/3-stop increments (or 1/2-stop increments with some cameras) as follows: Correct exposure, underexposure, and overexposure. FEB is canceled automatically after all three bracketed flash shots are taken.



Correct exposure.



Underexposure by -1 stop.



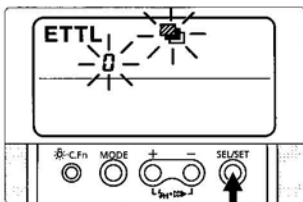

Overexposure by +1 stop.

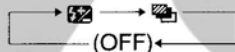

### 1 Press the <SEL/SET> button and select .

Pressing the <SEL/SET> button changes the blinking selection in the following loop:



The  icon and flash exposure bracketing amount will blink.

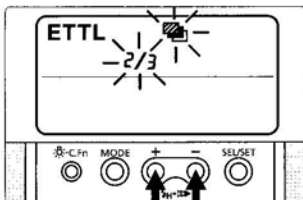

### 2 Press the <+> or <-> button to set the flash exposure bracketing amount.

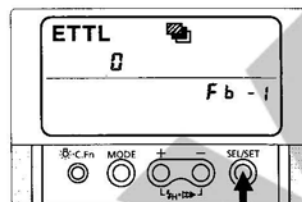

### 3 Press the <SEL/SET> button.

The MR-14EX's LCD panel display will be as shown on the left.

### 4 Focus the subject

When you press the shutter button halfway, the FEB setting is displayed on the viewfinder's right.

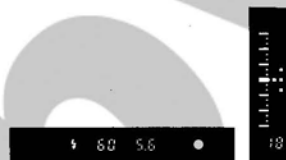







### 5 Take the picture.

Check that the  icon is displayed in the viewfinder before taking the picture.

### 6 Repeat steps 4 to 5 to take the remaining two bracketed shots.

After all three bracketed shots are taken, the FEB setting is cancelled automatically.

FEB cannot be used with any flash exposure compensation set with the camera.

- Before taking the picture, make sure that the MR-14EX's pilot lamp is lit or the  icon is displayed in the viewfinder. The  (single-frame) film advance mode is recommended.
- In the , , , or  continuous shooting mode with the EOS-1 V or EOS-3, the next bracketed picture will not be taken if the flash is not ready. While the flash is not ready, you can still take a picture in the normal AE mode if you release your finger from the shutter button and press it completely.
- With Type-A cameras other than the EOS-1 V and EOS-3, if the flash is not ready, you can still take pictures in the normal AE mode.
- When the flash is ready, you can resume taking the bracketed flash shots.

- FE lock and FEB can be used in combination.
- FEB and flash exposure compensation can be set together with the MR-14EX. In this case, the FEB amount will shift according to the flash exposure compensation amount.

**CF** C.Fn-1 can prevent the FEB setting from canceling automatically after the three bracketed flash shots are taken. (→p.64)

**CF** C.Fn-2 can change the sequence of the bracketed flash shots. (→p.64)

## High-Speed Sync (FP Flash)

With high-speed sync (FP flash), the MR-14EX can synchronize with the camera at all shutter speeds even those faster than the normal sync speed. When high-speed sync is set,  is displayed in the viewfinder.

\* High-speed sync can be used in the **ETTL** and **M** flash modes.

\* High-speed sync is especially effective for fill-flash in daylight, enabling you to:

- (1) Obtain better background blur with a larger aperture.
- (2) Soften shadows.

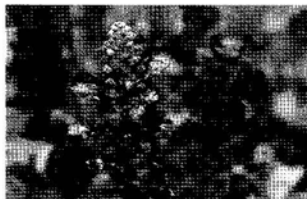

With normal flash.



With FP flash.

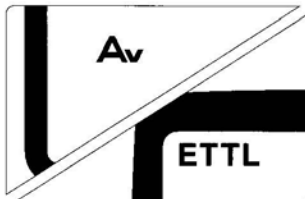

- 1 Select the camera's shooting mode and the MR-14EX's flash mode.

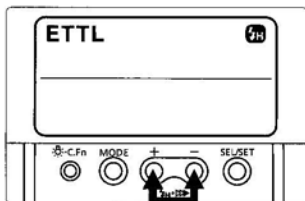

- 2 Press the **<+>** and **<->** buttons simultaneously to select .

▶ Each time you press the **<+>** and **<->** buttons simultaneously, the setting changes in the following loop.



 1000 2.8

### 3 Focus and take the picture.

- Check that the  icon is displayed in the viewfinder before taking the picture.

- To cancel high-speed sync, press the **<+>** and **<->** buttons simultaneously so that the  icon on the LCD panel turns off.
- If you want to use a large aperture (smaller f-number), set the **Av** or **M** mode.
- With high-speed sync, the MR-14EX's Guide No. changes depending on the shutter speed (→71). The faster the shutter speed, the smaller the Guide No. will be.
- When high-speed sync is used in the manual flash mode, the flash output ranges from 1/1 to 1/64.

# Manual Flash Mode

In the manual flash mode, you can set the flash output from 1/1 (full) to 1/64 power in whole-stop increments. The flash tubes can be fired in one of three configurations: 1. Fire both flash tubes at the same output, 2. Fire flash tube A at a different output from flash tube B, 3. Fire only one of the flash tubes.

## Firing Both Flash Tubes at the Same Output

**1** Set the camera's shooting mode to **A<sub>v</sub>** or **M**.

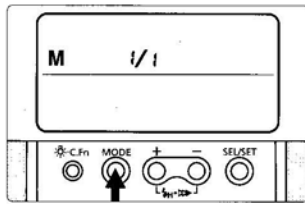

**2** Press the MR-14EX's <MODE> button and select **M**.

▶ Pressing the <MODE> button toggles the flash mode between **ETTL** and **M**.



**3** Press the <SEL/SET> button.  
▶ The flash output display blinks.

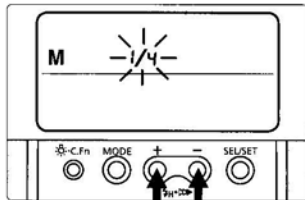

**4** Press the <+> or <-> button to set the desired flash output.  
▶ Each time you press the button, the flash output increases or decreases by one stop.

**5** Press the <SEL/SET> button again.  
▶ The flash output is displayed.

**6** Set the camera's aperture.

**7** Focus and take the picture.  
• Check that the  icon (flash ready) is displayed in the viewfinder before taking the picture.

 To determine the correct flash exposure, use a hand-held flash meter or take test shots.

## Firing Both Flash Tubes at a Different Output

For step 3 on the preceding page, following the procedure below to set a different flash output between flash tube A and B

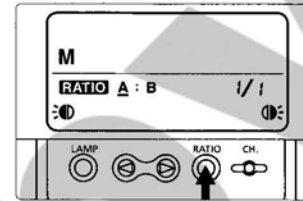

Press the <RATIO> button and select **RATIO A : B**.

▶ Each time you press the button, the selection will change in the following loop:

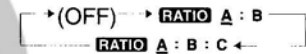

• The flash output is displayed on the lower right of the LCD panel. When **A** is displayed, the flash output displayed is for flash tube A.

**Press the <<> or <>> button to select flash tube A or B, then press the <+> or <-> button to set the flash output.**

▶ First select the flash tube, then set the flash output for that flash tube.  
• The remaining steps are the same as steps 6 and 7 on the preceding page.

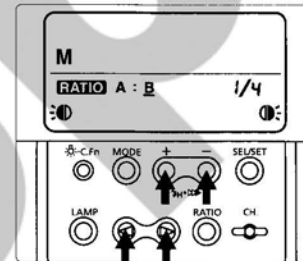

## Firing Only One Flash Tube

Press the <-> button and set the flash output to --. This disables the selected flash tube from firing.

• The -- setting comes after the 1/64 setting. The flash tube whose flash output is set to -- will not fire. Also, you cannot set -- for both flash tubes.

 To prevent overheating and deterioration of the flash tubes, observe the following limits for continuous shooting with flash. If you reach the limit, allow the MR-14EX to cool for at least 10 min.

(1) At 1/1 or 1/2 output: Max. 15 continuous flash shots.

(2) At 1/4 to 1/8 output: Max. 20 continuous flash shots.

(3) At 1/16, 1/32, or 1/64 output: Max. 40 continuous flash shots.

## ▶▶ Second-Curtain Synchronization

Normally, the flash fires in synchronization with the first shutter curtain when the shutter is fully open. With second-curtain synchronization, the flash fires immediately before the second shutter curtain closes at the end of the exposure.

**1 Set the shooting mode with the camera.**

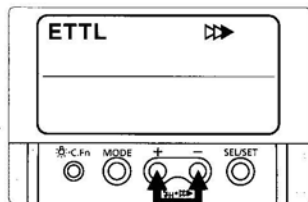

**2 Press the <+> and <-> buttons simultaneously to select ▶▶ on the LCD panel.**

- ▶ Each time you press the <+> and <-> buttons simultaneously, the synchronization mode changes in the following loop:

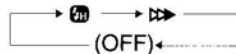

**3 Focus and take the picture.**

- ▶ Check that the ⚡ icon is displayed in the viewfinder before taking the picture.

- To cancel second-curtain synchronization, press the <+> and <-> buttons simultaneously to turn off the ▶▶ icon on the LCD panel.
- With the Rebel G/500N, TTL autoflash is used with second-curtain synchronization.
- Second-curtain synchronization does not work with the camera's □ (Full Auto) shooting mode and Programmed Image Control modes.

This chapter explains the MR-14EX's built-in features for wireless flash photography with one or more additional Speedlites.

- Setting Up a Wireless Flash System (→p.42)
- Using the Wireless Flash System (→p.45)

## For Type-A Cameras Wireless Flash Photography

- This chapter uses the EOS-1V, MR-14EX, and 550EX (slave unit) for explanatory purposes
- Before proceeding, turn on the camera and flash units' main switch.
- For EOS-1 V operations, refer to the EOS-1 V Instructions booklet.
- For wireless operations with Type-A cameras other than the EOS-1V, 3, Eian 7E/30 and D30, see **CF** on page 45.

# Setting Up a Wireless Flash System

By using a Speedlite 550EX as a slave unit, you can set up a wireless flash system with the MR-14EX.

## Setting the MR-14EX as the Master Unit

As with the Speedlite 550EX, the MR-14EX can be set as the master unit which transmits wireless signals to the slave unit.

### 1 Press the MR-14EX's <MODE> button and select E TTL.

- Pressing the <MODE> button toggles the flash mode between E TTL and M.

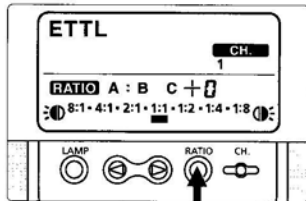
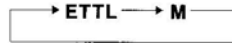

### 2 Press the <RATIO> button and select RATIO A : B C.

- Each time you press the button, the selection will change in the following loop:

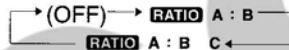

- CH. will be displayed.

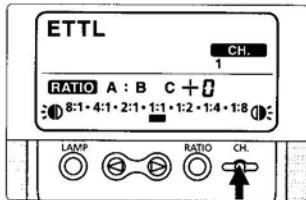

### 3 Press the <CH.> button to select the channel.

- Select a channel from 1 to 4.

⚠ Be sure to set the same channel No. for the master and slave unit. Otherwise, slave C will not fire.

## Setting the 550EX as a Slave Unit

To set the 550EX as a slave unit, refer to page 53 in the 550EX's Instructions booklet.

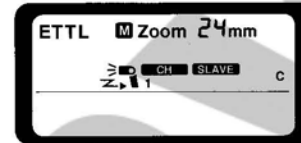

Set the same channel No. as the master unit.

Set the slave ID to C.

## Positioning and Test Firing

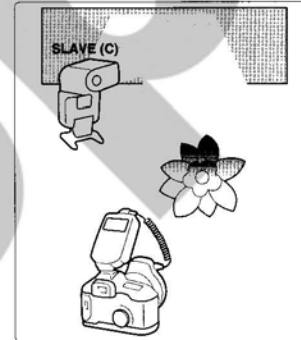

After setting up the wireless flash system, position slave C as shown in the left diagram.

- When indoors, position the slave unit within 5 meters from the master unit. When outdoors, position it within 3 meters. The slave unit should also be within an 80-degree angle in front of the master unit.
- Face the slave unit's transmission sensor toward the master unit.
- Indoors, the transmission signals can bounce off the walls so the slave unit's positioning can be a little more flexible.
- Do not place any objects between the master unit and slave unit which may obstruct the wireless transmission.

Check that the master unit's pilot lamp is lit and that slave C is flash-ready.

- When the slave unit is flash-ready, its AF-assist light will blink.

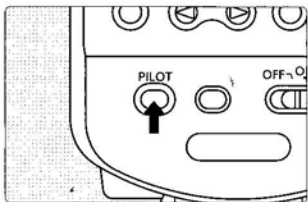

**3 Press the master unit's pilot lamp (test firing button) to fire a test flash.**

- The master unit and slave unit should fire (at 1/64 output).
- If the slave unit does not fire, reposition it closer to the master unit and more toward the front and center of the master unit. Then fire a test flash again.

- In a wireless flash system, the flash mode (E-TTL autoflash or manual flash), flash ratio, flash exposure compensation, FEB, FP flash, and other settings are all set with the master unit. The master unit transmits all these settings to the slave unit via wireless signals.
- Before taking the picture, you can fire a modeling flash (→p.29) to check the lighting effects.
- Test firing cannot be executed while the camera's metering is active for 6 sec.
- In the manual flash mode, the test flash will be fired at the manually-set flash output.

## Using the Wireless Flash System

### Using Slave C (w/EOS-1V, 3, Elan 7E/30, or D30)

You can fire flash tubes A and B and slave C at the same time. A correct flash exposure is obtained with flash tubes A and B together, and slave C alone is set automatically to obtain a correct exposure. Slave C is used to eliminate background shadows or to create accent lighting.

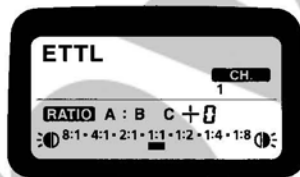

**Check that **RATIO A : B C** is displayed on the LCD panel.**

- If it is not displayed, press the <RATIO> button until it is displayed. (→p.42)

**Check that the master unit's pilot lamp is lit and that slave C is also flash-ready.**

**Focus and take the picture.**

**Check that the master unit's flash exposure confirmation lamp lights.**

- If the flash output of flash tube A or B or slave C is insufficient, the master unit's flash exposure confirmation lamp will not light.
- If you use slave C to illuminate the subject directly, overexposure of the subject may result.
- If you set **RATIO A : B**, slave C will not fire.
- In a wireless flash system, the master unit will always fire both flash tubes A and B. You cannot fire only one flash tube in a wireless flash system.

**CF** With Type-A cameras, C.Fn-5 can have both the master unit and slave unit fire together as one group. (→p.64)

- While **RATIO** is not displayed on the master unit, you can just position the slave unit as desired.

You can also set a flash ratio for flash tubes A and B and set flash exposure compensation for slave C. After step 1 on the preceding page, follow the procedure below.

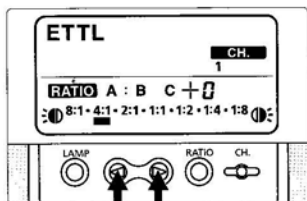

### Press the <<> or <>> button to set a flash ratio for flash tubes A and B.

- To set the flash ratio for flash tubes A and B, see page 27.
- The sample diagram on the left shows the left:right flash ratio set to 4:1.
- When **RATIO** is displayed, you can change the flash ratio anytime.

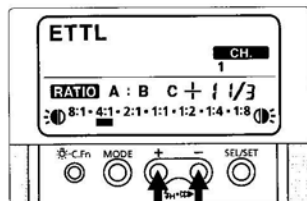

### Press the <+> or <-> button to set slave C's flash exposure compensation amount.

- The amount can be set up to  $\pm 3$  stops in 1/3- or 1/2-stop increments.
- The remaining steps are the same as steps 2 and 4 on page 45.

You can also use the <SEL/SET> button and the <+> and <-> buttons to set the flash ratio for flash tubes A and B and slave C's flash exposure compensation amount.

## Features Available with Wireless Flash

The following features can also be used in a wireless flash system:

- Wireless FE Lock
  - Wireless flash exposure compensation
  - Wireless flash exposure bracketing (FEB)
  - Wireless high-speed sync (FP flash)
- To set the above features, see pages 30 to 37.
- You set all the above features with the master unit. You need not touch the slave unit's controls.

## Wireless Manual Flash

With all Type-A cameras, you can also set up a wireless manual flash system.

### Setting the flash output for flash tubes A and B and slave C

With **RATIO A : B : C** displayed on the master unit, set the flash output for flash tubes A and B. Then set the flash output for slave C. For the setting procedure, see "Firing Both Flash Tubes at a Different Output" on page 39.

To determine the correct flash exposure, use a hand-held flash meter or take test shots.

- **CF** With all Type-A cameras, C.Fn-5 can set the same flash output for flash tubes A and B and slave C. (→p.64)
  - While **RATIO** is not displayed on the master unit, you can just set the flash output with the master unit.



## Wireless Slave Groups

When C.Fn-5-1 is set, you can use additional Speedlites and set their slave IDs to A, B, or C. (→p.64)

By having multiple Speedlites set to the same slave ID, you can create a slave group to produce a brighter flash. For example, a slave unit whose slave ID is A will fire together with flash tube A. Each slave group is treated as one Speedlite, with the same flash settings applied to all the Speedlites in the group.

There is no limit as to the number of slave units that can belong to one group.

With the EOS-1V, 3, Elan 7E/30, or D30, E-TTL autoflash control can be applied individually to each of the three A, B, and C slave groups. With other Type-A EOS cameras, the same E-TTL autoflash control is applied to all three groups. In the manual flash mode, all Type-A EOS cameras can apply E-TTL autoflash control individually to each of the three slave groups.

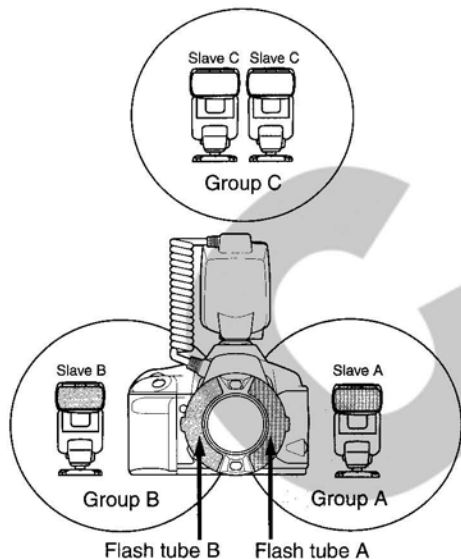

When the MR-14EX is mounted on a Type-B camera such as the EOS-1N, taking flash pictures with TTL autoflash is just as easy as normal autoexposure (AE) pictures. In the Full Auto mode, you can just press the shutter button to take flash pictures. Or you can set the shutter speed or aperture while the flash exposure is automatic. In this way, you can take various flash pictures.

With the EOS-1N, the flash exposure is controlled with the 3-zone, TTL autoflash system (real-time off-the-film flash metering).

## For Type-B Cameras Basic Flash Photography

📌 In macro photography, setting the correct exposure greatly depends on the subject. It would be best to bracket the exposure even for the same subject. (→p.56)

- 📖 This section uses the EOS-1N as the Type-B camera.
- Before proceeding, first turn on the Main Switch on the EOS-1N and MR-14EX.
- For EOS-1N operations, refer to the EOS-1N Instructions booklet.

## Using Flash with the Camera's Shooting Modes

For TTL autoflash shots, just set the camera's shooting mode to **P** (Program AE), **Av** (aperture-priority AE), or **M** (Manual exposure). For serious closeup flash photography, **Av** or **M** is recommended.

\* When you press the shutter button completely, TTL autoflash metering (the light reflected off the film is metered and the flash is cut off when the proper amount of light is received) is used to control the flash exposure based on the flash aperture.

### P: Program AE Mode and TTL Autoflash

Set the camera's shooting mode to **P**, and the camera will set the flash aperture and shutter speed automatically. You can thereby concentrate on the subject.

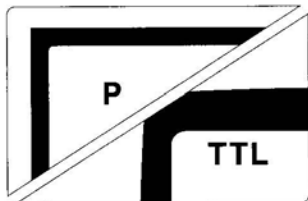

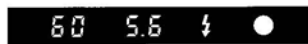

1 Set the camera's shooting mode to **P**.

2 Set the MR-14EX's flash mode to **TTL**.



3 Focus and take the picture.

- Check that the  icon (flash ready) is displayed in the viewfinder before taking the picture.

- If the camera has the Full Auto mode  and it is set to this mode, the shutter speed and aperture will be set in the same way as with the **P** mode (Program AE).
- If the **DEP** mode (depth-of-field AE) is used with the MR-14EX, it will be the same as using the **P** mode.
- If the **TV** mode (shutter speed-priority AE) is used to set the shutter speed, the camera will set the flash aperture automatically. Since you cannot set the desired aperture in this mode, it is not recommended for closeup flash photography.

### Av: Aperture-Priority AE and TTL Autoflash

This mode is effective for controlling the depth of field in your flash pictures. You can also obtain a correct exposure for both the subject and background. You set the aperture and the camera sets the shutter speed automatically for the correct exposure of the background. The TTL autoflash system obtains the correct flash exposure based on the aperture you set.



1 Set the camera's shooting mode to **Av** and set the aperture.



2 Set the MR-14EX's flash mode to **TTL**.



3 Focus and take the picture.

- Check that the  icon (flash ready) is displayed in the viewfinder before taking the picture.

- In low-light conditions, the shutter speed will be slow. Use a tripod.
- If you take the picture while the focusing lamp is on, underexposure may result. Wait until the focusing lamp turns off, then take the picture.

- If the top shutter speed display blinks, the background will be overexposed. Or if the slowest shutter speed (30") display blinks, the background will be underexposed. In such cases, change the aperture until the shutter speed display stops blinking.

## M: Manual Exposure and TTL Autoflash

In this mode, you set both the shutter speed and aperture. The TTL autoflash system controls the flash exposure based on the aperture you set. The proper exposure of the background is set with both the aperture and shutter speed.



**1** Set the camera's shooting mode to **M** and set the aperture and shutter speed.

- Set the desired aperture and the shutter speed anywhere from 30 sec. to the top sync speed. You can also use buLb.

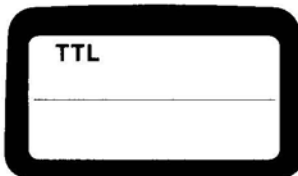

**2** Set the MR-14EX's flash mode to TTL.



**3** Focus and take the picture.

- Check that the ⚡ icon (flash ready) is displayed in the viewfinder before taking the picture.

 With the EOS-1N and EOS-1, you can check the background exposure level by looking at the exposure level indicator in the viewfinder.

The MR-14EX's advanced features are explained in this chapter. They are as follows:

- Selecting the Flash Tube (→p.54)
- Flash Exposure Compensation (→p.56)
- FEB (Flash Exposure Bracketing) (→p.58)
- Manual Flash Mode (→p.60)
- Second-Curtain Synchronization (→p.62)
- Wireless Manual Flash (→p.63)

## For Type-B Cameras Advanced Flash Photography

-  • This section uses the EOS-1N as the Type-B camera.
- Before proceeding, first turn on the Main Switch on the EOS-1N and MR-14EX.
  - For EOS-1N operations, refer to the EOS-1N Instructions booklet.

## ☺☹: Selecting the Flash Tube

By firing only one of the flash tubes or both flash tubes, you can create shadows and sculptural lighting effects.

- \* The TTL flash mode must be set.
- \* If you set the flash mode to **M**, see page 61.

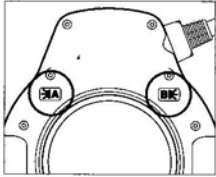

The flash tube ID is "A" for the left one and "B" for the right one when you look at the rear of the flash ring.



Only flash tube A fired. Both flash tubes fired. Only flash tube B fired.

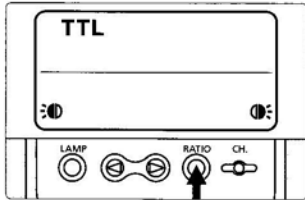

- 1 Press the <RATIO> button.
  - ▶ The ☺ and ☹ icons will be displayed.

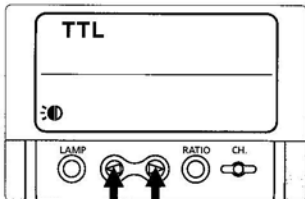

- 2 Press the <<> or <>> button to select the flash tube(s).
  - ☺☹: ☺A and ☹B will fire.
  - ☺☺: ☺A will fire.
  - ☹☹: ☹B will fire.

## 3 Focus and take the picture.

- Check that the ⚡ icon (flash ready) is displayed in the viewfinder before taking the picture.

- A flash ratio cannot be set. You can fire both flash tubes at the same output or fire only one of the flash tubes.

## Uniform Modeling Flash

Set C.Fn-4-1 (→p.64). Then you can press the test firing button to fire a modeling flash to see the lighting and shadow effects before taking the picture.

- \* The modeling flash is fired at 70 Hz for 1 sec.
- To prevent overheating and deterioration of the flash tubes, do not fire the modeling flash more than 10 times in succession. After 10 times, allow the MR-14EX to cool for at least 10 minutes.

## Flash Exposure Compensation

With the MR-14EX, you can set the flash exposure compensation up to  $\pm 3$  stops in 1/3-stop increments (or 1/2-stop increments with some cameras). In tandem, you can also set exposure compensation with the camera to control the background's exposure level in the flash picture.

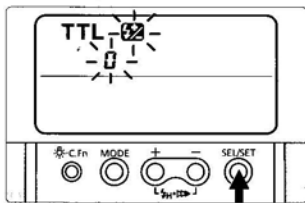

### 1 Press the <SEL/SET> button and select .

Pressing the button changes the blinking selection in the following loop:

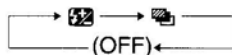

The  icon and flash exposure compensation amount will blink.

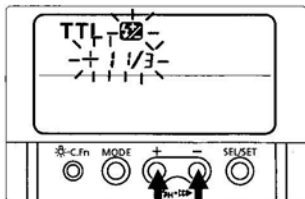

### 2 Press the <+> or <-> button to set the desired flash exposure compensation amount.

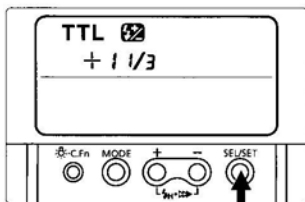



### 3 Press the <SEL/SET> button.

The  icon and flash exposure compensation amount will be displayed.

### 4 Focus the subject.

When you press the shutter button halfway, the  icon will be displayed on the viewfinder bottom.

### 5 Take the picture.

- Check that the  and  icons are displayed in the viewfinder before taking the picture.

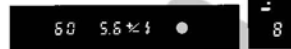

- Flash exposure compensation set with the MR-14EX overrides any flash exposure compensation set with the camera.
- In step 3, instead of pressing the <SEL/SET> button, you can press the shutter button halfway to set the flash exposure compensation.
- If you take a picture during step 2 (while the flash exposure compensation amount is still blinking), the flash exposure compensation will take effect in the picture according to the blinking amount.
- If the subject is small and the background is dark or far away, flash exposure compensation may not obtain the desired result. In such a case, use the manual flash mode. (→p.60)



### How exposure compensation affects the flash picture

	Effect
TTL flash exposure compensation	Changes the flash exposure of the subject.
AE exposure compensation	Changes the background exposure.
Changing the ISO film speed setting	Changes both the flash (subject) exposure and background exposure.

## FEB (Flash Exposure Bracketing)

You can change the flash exposure level automatically while keeping the background exposure level the same. Three flash shots can be bracketed up to  $\pm 3$  stops in 1/3-stop increments (or 1/2-stop increments with some cameras) as follows: Correct exposure, underexposure, and overexposure. FEB is canceled automatically after all three bracketed flash shots are taken.



Correct exposure.



Underexposure by -1 stop.



Overexposure by +1 stop.

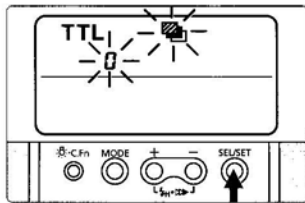

### 1 Press the <SEL/SET> button and select .

Pressing the <SEL/SET> button changes the blinking selection in the following loop:



The  icon and flash exposure bracketing amount will blink.

### 2 Press the <+> or <-> button to set the flash exposure bracketing amount.

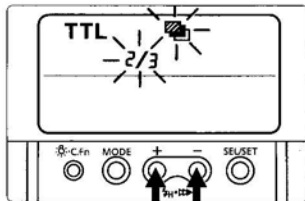

### 3 Press the <SEL/SET> button.

The MR-14EX's LCD panel display will be as shown on the left

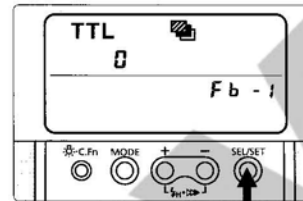

### 4 Focus the subject.

When you press the shutter button halfway, the  $\frac{1}{2}$  icon is displayed on the viewfinder's bottom.



### 5 Take the picture.

Check that the  $\frac{1}{2}$  and  $\frac{1}{2}$  icons are displayed in the viewfinder before taking the picture.

### Repeat steps 4 to 5 to take the remaining two bracketed shots.

After all three bracketed shots are taken, the FEB setting is cancelled automatically.

FEB cannot be used with any flash exposure compensation set with the camera.

- Before taking the picture, make sure that the MR-14EX's pilot lamp is lit or the  $\frac{1}{2}$  icon is displayed in the viewfinder. The  (single-frame) film advance mode is recommended.
- If the flash is not ready, you can still take pictures in the normal AE mode. When the flash is ready, you can resume taking the bracketed flash shots.

FEB and flash exposure compensation can be set together with the MR-14EX. In this case, the FEB amount will shift according to the flash exposure compensation amount.

**CF** C.Fn-1 can prevent the FEB setting from canceling automatically after the three bracketed flash shots are taken. (→p.64)

**CF** C.Fn-2 can change the sequence of the bracketed flash shots. (→p.64)

# M Manual Flash Mode

In the manual flash mode, you can set the flash output from 1/1 (full) to 1/64 power in whole-stop increments. The flash tubes can be fired in one of three configurations: 1. Fire both flash tubes at the same output, 2. Fire flash tube A at a different output from flash tube B, 3. Fire only one of the flash tubes.

## Firing Both Flash Tubes at the Same Output

- 1 **Set the camera's shooting mode to Av or M.**
- 2 **Press the MR-14EX's <MODE> button and select M.**
  - Pressing the <MODE> button toggles the flash mode between TTL and M.
- 3 **Press the <SEL/SET> button.**
  - The flash output display blinks.
- 4 **Press the <+> or <-> button to set the desired flash output.**
  - Each time you press the button, the flash output increases or decreases by one stop.
- 5 **Press the <SEL/SET> button again.**
  - The flash output is displayed.
- 6 **Set the camera's aperture.**
- 7 **Focus and take the picture.**
  - Check that the  $\frac{1}{2}$  icon (flash ready) is displayed in the viewfinder before taking the picture.

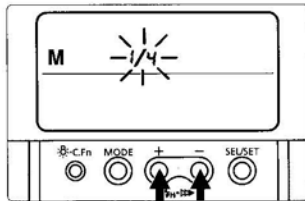
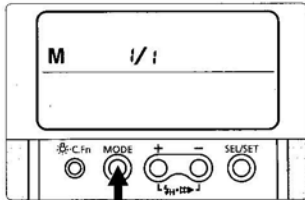

 To determine the correct flash exposure, use a hand-held flash meter or take test shots.

## Firing Both Flash Tubes at a Different Output

After step 3 on the preceding page, following the steps below to set a different flash output between flash tube A and B.

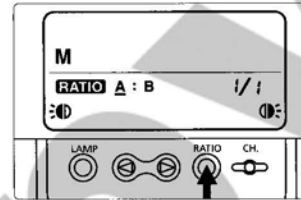

**Press the <RATIO> button and select RATIO A : B .**

- Each time you press the button, the selection will change in the following loop:

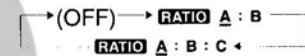

- The flash output is displayed on the lower right of the LCD panel. When A is displayed, the flash output displayed is for flash tube A.

**Press the <<> or <>> button to select flash tube A or B, then press the <+> or <-> button to set the flash output.**

- First select the flash tube, then set the flash output for that flash tube.
- The remaining steps are the same as steps 6 and 7 on the preceding page.

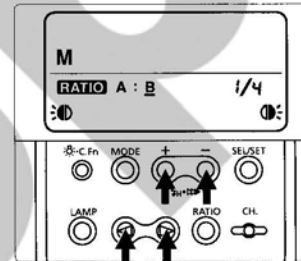

## Firing Only One Flash Tube

Press the <-> button and set the flash output to --. This disables the selected flash tube from firing.

- The -- setting comes after the 1/64 setting. The flash tube whose flash output is set to -- will not fire. Also, you cannot set -- for both flash tubes.
- ⚠ To prevent overheating and deterioration of the flash tubes, observe the following limits for continuous shooting with flash. If you reach the limit, allow the MR-14EX to cool for at least 10 min.
  - (1) At 1/1 or 1/2 output: Max. 15 continuous flash shots.
  - (2) At 1/4 to 1/8 output: Max. 20 continuous flash shots.
  - (3) At 1/16, 1/32, or 1/64 output: Max. 40 continuous flash shots.

## ▶▶ Second-Curtain Synchronization

Normally, the flash fires in synchronization with the first shutter curtain when the shutter is fully open. With second-curtain synchronization, the flash fires immediately before the second shutter curtain closes at the end of the exposure.

1 Set the shooting mode with the camera.

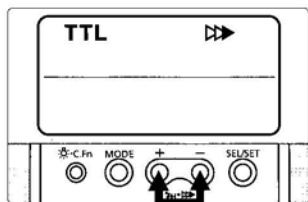

2 Press the <+> and <-> buttons simultaneously to select ▶▶ on the LCD panel.

- Each time you press the <+> and <-> buttons simultaneously, the synchronization mode changes in the following loop:

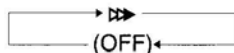

3 Focus and take the picture.

- Check that the  $\frac{1}{2}$  icon is displayed in the viewfinder before taking the picture.

- To cancel second-curtain synchronization, press the <+> and <-> buttons simultaneously to turn off the ▶▶ icon on the LCD panel.
- Second-curtain synchronization does not work with the camera's  $\square$  (Full Auto) shooting mode and Programmed Image Control modes.

## Wireless Manual Flash

With all Type-B cameras, you can also set up a wireless manual flash system.

- \* To set up a wireless flash system, follow the same procedure for Type-A cameras on page 42 to 44.
- \* Wireless autoflash is not possible.

### Setting the flash output for flash tubes A and B and slave C

With **RATIO** A : B : C displayed on the master unit, set the flash output for flash tubes A and B. Then set the flash output for slave C. For the setting procedure, see "Firing Both Flash Tubes at a Different Output" on page 61.

- To determine the correct flash exposure, use a hand-held flash meter or take test shots.

**CF** With all Type-B cameras, C.Fn-5 can set the same flash output for flash tubes A and B and slave C. (→p.64)

- While **RATIO** is not displayed on the master unit, you can just set the flash output with the master unit.

### Wireless Slave Groups

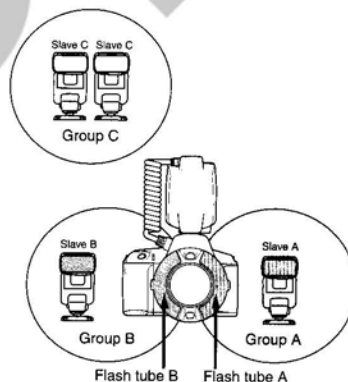

When C.Fn-5-1 is set, you can use additional Speedlites and set their slave IDs to A, B, or C. (→p.65) By having multiple Speedlites set to the same slave ID, you can create a slave group to produce a brighter flash. For example, a slave unit whose slave ID is A will fire together with flash tube A. Each slave group is treated as one Speedlite, with the same flash settings applied to all the Speedlites in the group. There is no limit as to the number of slave units that can belong to one group.



## CF Custom Functions

Custom Functions enable you to customize the MR-14EX's functions according to your preferences.

### Setting a Custom Function

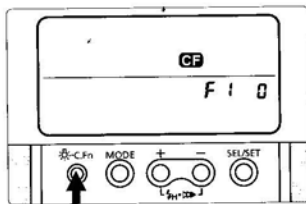

**1 Press the <C.Fn> button for at least 2 sec.**

- The **CF** icon, Custom Function No., and setting No. will appear on the LCD panel.

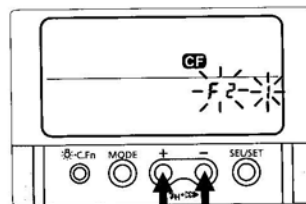

**2 Press the <SEL/SET> button.**

- The Custom Function No. and setting No. will start blinking.
- Each time you press the button, the next Custom Function No. will appear from F1 to F7.

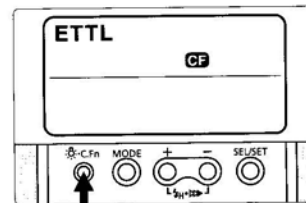

**3 Press the <+> or <-> button to set the Custom Function setting.**

- Set it to 0 or 1 according to your preference.

**4 Press the <SEL/SET> button.**

- The display stops blinking, and the Custom Function is set.

**5 Press the <C.Fn> button or the <MODE> button**

- The MR-14EX is now ready for picture-taking.
- You need not press the <C.Fn> button for 2 sec. or longer.

When a Custom Function has been set, the **CF** icon is always displayed on the LCD panel.

### Custom Function Settings

Function	Custom Function No.	Setting No	Description
FEB cancellation after completion	C.Fn-1	0	Enabled
		1	Disabled (FEB continues)
FEB sequence	C.Fn-2	0	Correct exposure, underexposure, overexposure
		1	Underexposure, correct exposure, overexposure
Flash metering system	C.Fn-3	0	E-TTL autoflash
		1	TTL autoflash
Test firing button	C.Fn-4	0	With E-TTL autoflash, fire at full output With manual flash, fire at the set output
		1	Uniform modeling flash
Wireless slave control	C.Fn-5	0	Slave C only
		1	Slaves A, B, and C
Modeling flash with flash ratio	C.Fn-6	0	Enabled
		1	Disabled (Depth-of-field preview)
Power source for flash charging	C.Fn-7	0	Internal power + External power
		1	External power only

C.Fn-4: Setting this to "1" will have the flash heads fire the modeling flash fire at the same output with all EOS cameras. If both flash heads have been set to fire with autoflash, both flash heads will fire the modeling flash at the same output. In the manual flash mode, the modeling flash will be fired at the flash ratio set manually.

C.Fn-5: When this is set to "1", slave units whose ID is A or B will fire as part of the same slave group as flash tube A or B respectively.

C.Fn-7: When an external power pack is used, the flash unit uses both the internal and external power sources to recharge the flash. However, the internal power source may become exhausted sooner than the external power pack, preventing the flash from firing. By setting this Custom Function to "1," the flash unit will use only the external power pack to recharge the flash so that the internal power source will last longer. (The focusing lamp is always powered by the internal power source.)

- With a Type-A camera, the C.Fn-3-1 setting will not enable wireless operation with autoflash.
- With the EOS D30 camera, setting C.Fn-3-1 will disable the flash.
- If C.Fn-5-1 is set, you cannot have only one flash tube firing.

With a Type-B camera, TTL autoflash will be set regardless of the C.Fn-3 setting.

## MR-14EX/MT-24EX System

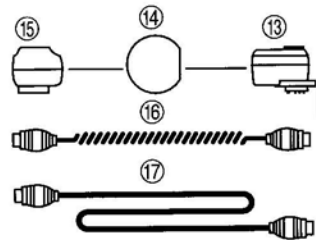
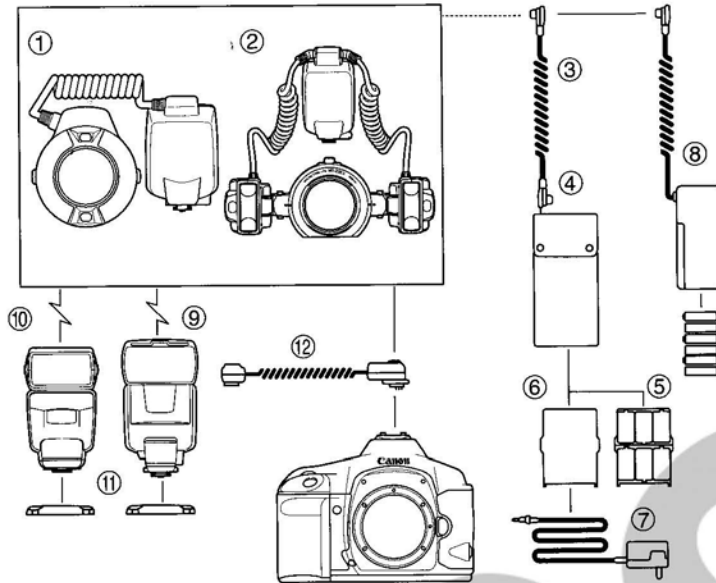

The accessories on the left enable wired, multi-Speedlite TTL autoflash.

- ⑬ TTL Hot Shoe Adapter 3
- ⑭ TTL Distributor
- ⑮ Off-Camera Shoe Adapter OA-2
- ⑯ Connecting Cord 60
- ⑰ Connecting Cord 300

- ① **Macro Ring Lite MR-14EX**
- ② **Macro Twin Lite MT-24EX**
- ③ **Connecting Cord ET** (included with Transistor Pack E)
- ④ **Transistor Pack E**  
Houses Battery Magazine TP or Ni-Cd Pack TP.
- ⑤ **Battery Magazine TP**  
Houses six size-C alkaline batteries.
- ⑥ **Ni-Cd Pack TP**  
Ni-Cd pack dedicated to Transistor Pack E.  
Shortens flash recycle time as with a high-voltage battery. Rechargeable with Ni-Cd Charger TP for repeated use.
- ⑦ **Ni-Cd Charger TP**  
Dedicated charger for Ni-Cd Pack TP. Charging time is about 15 hours.
- ⑧ **Compact Battery Pack CP-E2**  
Small and lightweight external power source. It uses six size-AA alkaline or nickel-hydrate batteries. It can also use lithium batteries.
- ⑨ **Speedlite 550EX** (Slave unit)
- ⑩ **Speedlite 420EX** (Slave unit)
- ⑪ **Mini Stand** (provided with the 550EX and 420EX)  
Mini stand to prop up the 550EX or 420EX positioned as a remote slave unit. Tripod socket provided at the bottom.
- ⑫ **Off-Camera Shoe Cord 2**  
For off-camera flash operation up to 60 cm away from the camera. All flash functions can be used. (Not compatible with the EOS 630/600 and RT.)

## Troubleshooting Guide

The flash does not fire.	The MR-14EX's mounting foot is not securely mounted on the camera's hot shoe. ▶ Slide the mounting foot all the way into the hot shoe. (→p.13) The camera's hot shoe contacts or the MR-14EX's contacts are soiled. ▶ Clean the contacts. (→p.13)
The flash does not fire even after I connected the external power pack installed with new batteries.	Batteries have not been installed in the MR-14EX. ▶ Install batteries in the MR-14EX. (→p.10) The batteries in the MR-14EX are exhausted. ▶ Install new batteries in the MR-14EX. (→p.10)
The pictures came out underexposed (or overexposed).	Flash exposure compensation has been set. ▶ Cancel the flash exposure compensation. (→p.32, 56)
I want to fire only one flash tube, but I can't.	C.Fn-5-1 has been set. ▶ Set C.Fn-5-0. (→p.64) RATIO A : B C (RATIO A : B : C) has been set ▶ Set to RATIO A : B. (→ 27, 39, 61)
The power turns off automatically when I don't use the MR-14EX.	The main switch is set to SE. ▶ Set the main switch to ON. (→p.15) ▶ Press the test firing button. (→p.16)
I can't detach the MR-14EX from the camera's hot shoe.	The locking collar has not been loosened enough. ▶ Loosen the locking collar until the locking pin disengages. (→p.13)
Although I have a Type-A camera, wireless autofocus does not work.	C.Fn-3-1 has been set. ▶ Set C.Fn-3-0. (→p.64)
The slave unit does not fire.	The slave unit's wireless selector is set to OFF or MASTER. ▶ Set the wireless selector to <b>SLAVE</b> . (→p.16 of 550EX Instructions/→p.13 of 420EX Instructions) The slave unit is not within the master unit's wireless transmission range. ▶ Position the slave unit within the master unit's wireless transmission range. (→p.43, 63) The slave unit's transmission sensor is not facing toward the master unit. ▶ Face the slave unit's transmission sensor toward the master unit. (→p.43, 63)
When I use slave C, the picture comes out overexposed.	Slave C is pointed directly at the front of the subject. ▶ Use slave C in another way. (→p.43)

## Specifications

Type .....	Closeup photography-dedicated, ring-type flash with two flash tubes, wireless transmission/reception functions, and E-TTL/TTL autofocus control
Compatible cameras .....	Type-A EOS cameras (for E-TTL autofocus control) Type-B EOS cameras (for TTL autofocus control)
Compatible lenses.....	EF 50mm f/2.5 COMPACT MACRO, EF 100mm f/2.8 MACRO USM, EF 100mm f/2.8 MACRO, EF 180mm f/3.5L MACRO USM, and MP-E 65mm f/2.8 1-5x
Flash coverage.....	80 deg. vertical, 80 deg. horizontal
Guide No .....	(→p.71)
Flash count and recycling time.....	(→ p.11, 12)
Flash modes.....	(1) E-TTL autofocus (w/Type-A cameras) • FE lock, flash exposure compensation, FEB, flash ratio control (2) TTL autofocus (w/Type-B cameras) • Flash exposure compensation, FEB (3) Manual flash (w/Type-A/B cameras) • 1/1 - 1/64, whole-stop increments, 7 steps
Firing mode .....	(1) Normal flash (2) High-speed sync (FP flash) (3) Test flash (4) Modeling flash • With C.Fn-6-0: Modeling flash with flash ratio (w/EOS-1V, 3, Elan 7E/30, or D30) • With C.Fn-4-1: Uniform modeling flash (w/all EOS cameras) (5) Preflash
Flash tube firing mode.....	(1) Both flash tubes firing • Both flash tubes fired at the same output (E-TTL/TTL autofocus) • Both flash tubes fired according to a flash ratio (E-TTL autofocus) • Both flash tubes fired manually (Manual flash) (2) Only one flash tube firing (All flash modes) Only flash tube A or B fired
High-speed sync .....	Enabled in E-TTL autofocus and manual flash modes
Flash exposure compensation.....	(1) Automatic compensation: Automatic flash output reduction for fill flash. (2) Manual adjustment of flash exposure compensation w/the MR-14EX: Up to ±3 stops in 1/3- or 1/2-stop increments (3) Manual adjustment of flash exposure compensation w/the camera: Up to ±3 or ±2 stops in 1/3- or 1/2-stop increments
FEB.....	Adjustable with the MR-14EX: Up to ±3 stops in 1/3- or 1/2-stop increments
Flash tube A:B ratio control.....	1:8 - 1:1 - 8:1, 1/2-stop increments, 13 steps
Shutter curtain sync .....	1st- or 2nd-curtain sync enabled
Flash-ready indicator.....	Red pilot lamp
Flash range (at f/2.8, ISO 100).....	(1) Normal flash: Approx. 20mm - 5 m/0.8 in - 16 ft (2) High-speed sync (FP flash) at 1/320 sec.: Approx. 20mm - 2.2 m/0.8 in - 7.2 ft
Flash exposure confirmation .....	Pilot lamp lights in yellow-green (for 3 sec.) immediately after the picture is taken.
Sync speed .....	(→ p.72)
Flash duration .....	(1) Normal flash: 1.4 ms or less (2) High-speed sync (FP flash): 26 ms or shorter.
Color temperature .....	Approx. 5500 K (Equivalent to daylight)

Focusing lamps ..... Coverage: 40 deg. vertical, 45 deg. horizontal  
Light duration: Approx. 20 sec.

Wireless Functions  
Transmission system Optical pulse transmission  
Configuration EOS camera, MR-14EX, and 550EX (slave)  
Firing control Slaves centrally controlled by MR-14EX master unit  
Slave groups [E-TTL autoflash]  
With EOS-1V, 3, Elan 7E/30, and D30: Max. 3 groups (A, B, C)  
With other Type-A cameras: 1 group (no ID)  
[Manual Flash]  
Max. 3 groups (A, B, C) with both Type-A and B cameras

Flash modes  
(1) E-TTL autoflash (w/Type-A cameras)  
(2) Manual autoflash (w/Type-A/B cameras)

Channels 1 to 4  
Transmission angle Same as flash coverage  
Transmission range (w/slave facing the master straight on) Indoors: Approx. 20 cm - 5 m/0.65 ft - 16.4 ft  
Outdoors: Approx. 20 cm - 3 m/0.65 ft - 9.8 ft

Film speed ..... Set automatically according to the camera's setting (ISO 6 - 6400)

Custom Functions ..... (→ p.64)

Main switch ..... 3 positions: OFF, ON, SE (turns off after 90 sec. of idle)

Power source ..... [Internal power sources] (→ p.11)  
(1) Size-AA alkaline batteries x 4  
(2) Size-AA nickel-hydride batteries x 4  
• Size-AA lithium batteries x 4 also can be used.  
[External power sources] (→ p.12, 66)  
(1) Compact Battery Pack CP-E2  
(2) Transistor Pack E

Dimensions ..... Control unit: 74.0 (W) x 125.9 (H) x 97.4 (D) mm  
2.9 (W) x 5.0 (H) x 3.8 (D) in  
Flash ring: 112.8 (W) x 126 (H) x 25.6 (D) mm  
4.4 (W) x 5.0 (H) x 1.0 (D) in  
Cord length: Approx. 25 cm/9.8 in

Weight ..... 430g/15.1 oz (excluding batteries)

- Specifications are based on Canon's testing criteria.
- Specifications and the product exterior are subject to change without notice.

Guide No.

[Normal Flash]

(At ISO 100 in meters/feet)

Flash Output	1/1	1/2	1/4	1/8	1/16	1/32	1/64
Guide No.	14.0/46.2	10.0/33	7.0/23.1	5.0/16.5	3.5/11.5	2.5/8.2	1.8/5.9

[High-Speed Sync (FP Flash)]

(At ISO 100 in meters/feet)

Shutter Speed (sec.)	1/125	1/160	1/200	1/250	1/320	1/400	1/500	1/640
Guide No.	7.9/26	7.6/25	7.2/23.7	6.8/22.4	6.2/20	5.5/18.1	4.9/16.1	4.4/14.5

Shutter Speed (sec.)	1/800	1/1000	1/1250	1/1600	1/2000	1/2500	1/3200	1/4000
Guide No.	3.9/12.8	3.5/11.5	3.1/10.2	2.7/8.9	2.4/7.9	2.2/7.2	1.9/6.2	1.7/5.6

Shutter Speed (sec.)	1/5000	1/6400	1/6000
Guide No.	1.5/4.9	1.4/4.6	1.2/3.9

\* The above figures apply to both or only one flash tube firing at a manual flash output of 1/1.

Camera's Flash-Related Exposure Warnings

Mode	Warning Indication	Description	Remarks
Aperture-priority AE	Max. sync speed display blinks.	The background will be overexposed.	The flash exposure setting for the subject is correct. Changing the aperture may stop the shutter speed display from blinking.
Shutter speed-priority AE	Minimum aperture display blinks.	The background will be overexposed.	Only the flash exposure setting for the subject is correct.
	Maximum aperture display blinks.	The background will be underexposed.	
Program AE	Minimum aperture display blinks.	The subject is too bright.	Attach a neutral-density (ND) filter to the lens to reduce the amount of light received by the camera.

## Feature Availability Table

●: Available. x: Not available.

Camera	Camera's Max. Sync Speed (sec.)				Autoflash Control		Wireless Flash		FP Flash	FE Lock	Flash Exposure Compensation		FEB	Flash Ratio Control	Modeling Flash	2nd-Curtain Sync
	1/90	1/125	1/200	1/250	E-TTL	TTL	E-TTL	M			w/flash	w/camera				
EOS 650		●			x	●	x	●	x	x	x	x	x	x	x	●
EOS 620				●	x	●	x	●	x	x	x	x	x	x	x	●
EOS 750		●			x	●	x	x	x	x	x	x	x	x	x	x
EOS 850		●			x	●	x	x	x	x	x	x	x	x	x	x
EOS 630/600		●			x	●	x	●	x	x	●	x	●	x	x	●
EOS-1				●	x	●	x	●	x	x	●	x	●	x	x	●
EOS RT		●			x	●	x	●	x	x	●	x	●	x	x	●
EOS 10S/10		●			x	●	x	●	x	x	●	x	●	x	x	●
EOS 700		●			x	●	x	● <sup>*3</sup>	x	x	● <sup>*4</sup>	x	● <sup>*4</sup>	x	x	● <sup>*4</sup>
EOS 1000/1000F/ REBEL/REBEL S	●				x	●	x	●	x	x	●	x	●	x	x	●
EOS 100/ELAN		●			x	●	x	●	x	x	●	x	●	x	x	●
EOS REBEL II/REBEL S II/ 1000N/1000FN	●				x	●	x	●	x	x	●	x	●	x	x	●
EOS 5/A2/A2E				●	x	●	x	●	x	x	●	●	●	x	x	●
EOS 500/REBEL X/REBEL XS	●				x	●	x	●	x	x	●	x	●	x	x	●
EOS-1N/1N RS				●	x	●	x	●	x	x	●	●	●	x	x	●
EOS 5000/888	●				x	●	x	●	x	x	●	●	●	x	x	●
EOS 50/50E/ELAN II/ELAN II E		●			●	● <sup>*1</sup>	● <sup>*2</sup>	●	●	●	●	●	●	x	x	●
EOS REBEL G/500 N	●				●	● <sup>*1</sup>	● <sup>*2</sup>	●	●	●	●	x	●	x	x	●
EOS IX				●	●	● <sup>*1</sup>	● <sup>*2</sup>	●	●	●	●	●	●	x	x	●
EOS IX 7/IX Lite		●			●	● <sup>*1</sup>	● <sup>*2</sup>	●	●	●	●	x	●	x	x	●
EOS-3				●	●	● <sup>*1</sup>	●	●	●	●	●	●	●	●	● <sup>*5</sup>	●
EOS 3000/88	●				x	●	x	●	x	x	●	x	●	x	x	●
EOS 300/REBEL 2000	●				●	● <sup>*1</sup>	● <sup>*2</sup>	●	●	●	●	x	●	x	x	●
EOS-1V				●	●	● <sup>*1</sup>	●	●	●	●	●	●	●	●	● <sup>*5</sup>	●
EOS ELAN 7E/30		●			●	● <sup>*1</sup>	●	●	●	●	●	●	●	●	● <sup>*5</sup>	●
EOS D30				●	●	x	●	●	●	●	●	●	●	●	● <sup>*5</sup>	●
EOS 3000N/66	●				●	● <sup>*1</sup>	● <sup>*2</sup>	●	●	●	●	x	●	x	x	●

<sup>\*1</sup> With C.Fn-3-1 set.<sup>\*2</sup> Only one slave group can be controlled.<sup>\*3</sup> With the EOS 700, the aperture will be fixed at f/5.6 for bulb exposures.<sup>\*4</sup> Shutter-priority AE is possible.<sup>\*5</sup> With C.Fn-6-0 set, modeling flash with flash ratio can be fired with the depth-of-field preview button.  
(With C.Fn-4-1 set, the test firing button fires a uniform modeling flash with all cameras.)





In this chapter, the features specific only to the MT-24EX are explained.

Any features not mentioned here are the same as the MR-14EX's and they are explained on pages 7 to 73 instead.

## Macro Twin Lite MT-24EX Features

---

 In macro photography, the correct exposure depends on the subject. To be safe, always bracket your exposures for each subject. (→p.32,56)

 Before proceeding with any operation, be sure to turn on the camera and the MT-24EX's main switch. (→p.15)

## Nomenclature

The nomenclature of the control unit and LCD panel is the same as the MR-14EX's control unit and LCD panel (see p. 7 and 8).

### Flash Head Assembly (Flash heads + Mount ring)

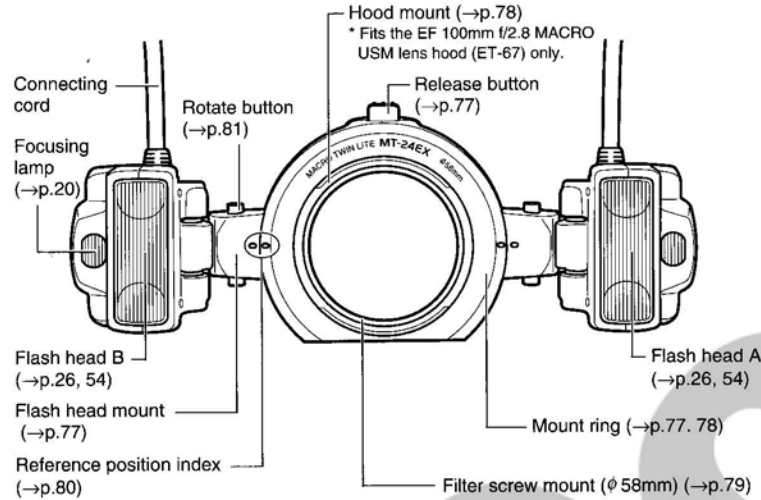

### Rear View

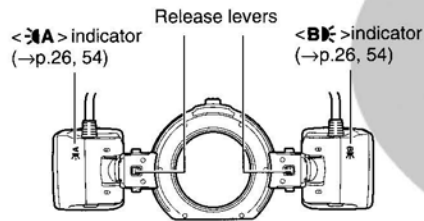

### Side/Bottom View

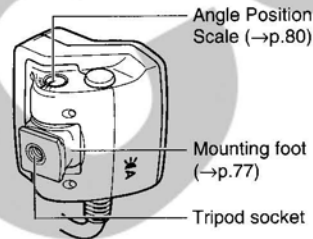

## Attaching the Flash Heads

The MT-24EX can be attached directly to the front of the following lenses: EF 50mm f/2.5 COMPACT MACRO, EF 100mm f/2.8 MACRO USM, EF 100mm f/2.8 MACRO, and MP-E 65mm f/2.8 1-5x. It can also be attached to the EF 180mm f/3.5L MACRO USM with the Macro Lite Adapter 72C (Optional). See p.14.

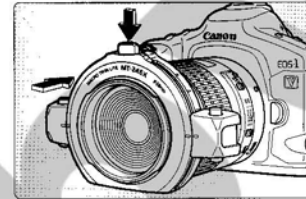

**Press and hold down the release button on the top of the mount ring.**

**Attach the mount ring to the front of the lens.**

- Keep the release button positioned upward at the center.
- Let go of the release button and make sure the mount ring is securely attached to the lens.
- While rotating the mount ring, be sure to hold down the release button.
- To detach the mount ring, follow the attachment procedure in reverse.

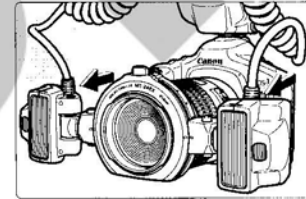

**Attach the flash heads to the flash head mounts.**

- Attach the control unit to the camera's hot shoe. (→p.13)
- Push in the guide mounting foot it snaps in place.
- To detach the flash heads, move the flash heads to the reference position (→p.80), then press the release lever to detach the heads.

- If the mount ring is attached to the EF 180mm f/3.5L MACRO USM lens and rotated without the release button being pressed, the Macro Lite Adapter 72C might over tighten on the lens filter screw threads and get stuck. To prevent this, be sure to hold down the release button while rotating the mount ring. If the Macro Lite Adapter 72C gets stuck, turn the mount ring without pressing the release button so that it is in close contact with the lens. Then turn it so that the Adapter detaches.

### Attaching the MP-E 65mm f/2.8 1-5x's Dedicated Hood

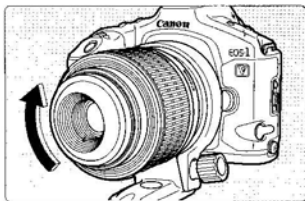

- 1 Attach the dedicated hood to the MP-E 65mm f/2.8 1-5x's filter screw mount.**

- The dedicated hood is optional.

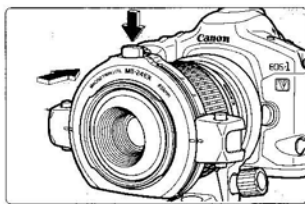

- 2 Attach the mount ring to the macro flash mount on the front of the lens.**

- Make sure it is securely attached.
- Attach the flash heads to the flash head mounts.

- !** If the MP-E 65mm f/2.8 1-5x's dedicated hood is attached to a different EF macro lens, flash obstruction may occur.

### Attaching the EF 100mm f/2.8 MACRO USM's Dedicated Hood ET-67

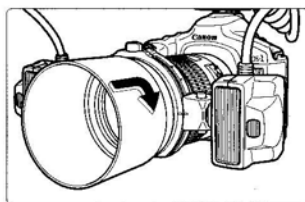

With the EF 100mm f/2.8 MACRO USM lens, you can also attach the ET-67 (Optional) hood to the bayonet mount on the front of the mount ring. **However, since the hood will obstruct part of the flash coverage, turn off the MT-24EX's main switch and use the existing light instead.**

### Attaching a Filter

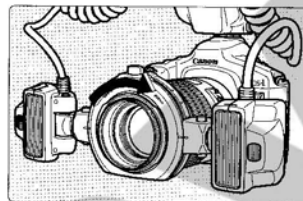

A 58mm dia. filter (Optional) can be screwed on to the mount ring.

- !** A filter cannot be attached to the mounting ring if you use the MP-E 65mm f/2.8 1-5x lens with the dedicated hood attached or if you use the EF 50mm f/2.5 COMPACT MACRO lens.
- !** With the EF 50mm f/2.5 COMPACT MACRO and EF 100mm f/2.8 MACRO lens, you can attach a 52mm filter directly to the lens and attach the mounting ring to it.



## Flash Head Movements

To suit the subject or shooting conditions, the flash heads can be tilted, swung, and rotated within the limits indicated below.

The flash head's reference position is set when the mount ring's reference position index is aligned with the flash head mount's index (both flash heads are open at 180°). This gives a straight, frontal flash.

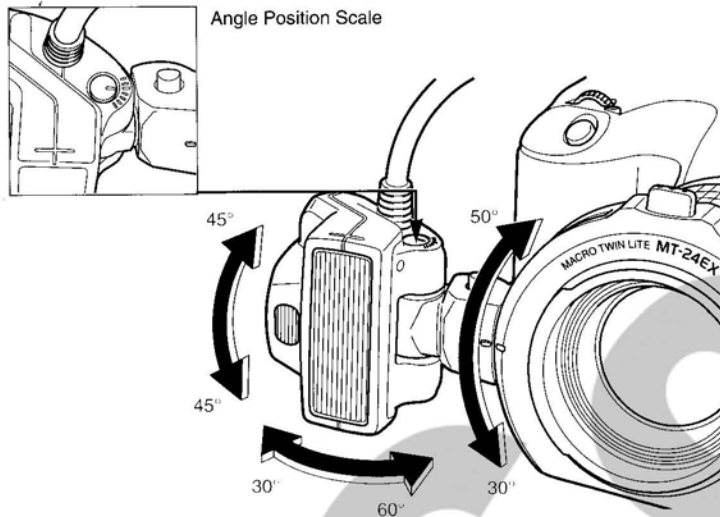

### Flash Head Movements

Direction		Angle*	Click Stops
Tilt	Upward	45°	22.5° increments
	Downward	45°	
Swing	Inward	60°	15° increments
	Outward	30°	
Mounting Ring Rotation	Up	50°	5° increments
	Down	30°	

\* Single flash head with respect to the reference position.

### Flash Head Tilt and Swing Movements

To tilt or swing the flash head, just grasp it by hand and tilt and swing it as desired.

When swinging the flash head inward or outward from the standard position, refer to the angle position scale (15° increments) on the side of the flash head.

- Do not swing or tilt the flash heads beyond the maximum angle. Doing so may cause the flash head to fall off the flash head mount.
- With the EF 50mm f/2.5 COMPACT MACRO lens, swinging flash head B outward will have it come into contact with your hand holding the camera grip.

### Rotating the Flash Heads on the Mount Ring

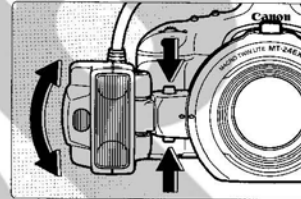

#### Hold down the rotate button.

- Use your fingers to hold down the button.

#### Rotate the flash head mount.

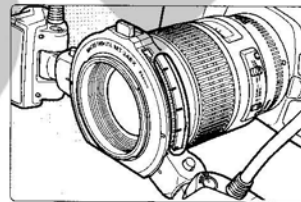

- While rotating the flash head mount, use the scale (15° increments) on the mount ring as a reference.

### Rotating the Mount Ring

Be sure to hold down the release button while rotating the mount ring with your hand. Let go of the release button at the desired mount ring position.

- If the EOS IX or EOS IX 7/IX Lite is used with the EF 50mm f/2.5 COMPACT MACRO lens, rotating the mount ring from the reference position will have the flash head hit the control unit. The flash heads therefore cannot be rotated 180° in this way.

### Setting the Flash Head Angle

The table below is a general guide to the flash head angle that should be set for the respective macro lens and magnification. Refer to the angle position scale (15° increments) on the side of the flash head and position both heads at the same angle. The angles specified in the table are inward angles with respect to the flash head's reference position.

Lens	Magnification	Inward Angle of Flash Head				
		60°	45°	30°	15°	0°
EF50mm f/2.5 COMPACT MACRO	1:2		●	●		
	1:2.5 - 1:3			●		
	1:4			●	●	
	1:5 - 1:6				●	
	1:8				●	●
	1:10					●
EF50mm f/2.5 COMPACT MACRO +LIFE-SIZE CONVERTER EF	1:1		●			
	1:1.2		●	●		
	1:1.5 - 1:2			●		
	1:4				●	
EF100mm f/2.8 MACRO USM	1:1 - 1:1.5			●		
	1:2			●	●	
	1:3				●	
	1:5					●
EF100mm f/2.8 MACRO	1:1		●			
	1:1.5			●		
	1:2			●	●	
	1:2.5 - 1:3				●	
EF180mm f/3.5L MACRO USM	1:4					●
	1:1			●	●	
	1:1.2 - 1:1.5				●	
MP-E65mm f/2.8 1-5 ×	1:2 - 1:10					●
	5 × - 2 ×	●				
	1 ×		●			

### Flash Distance Range

The MT-24EX's effective flash distance range greatly depends on the position and angle of the flash heads. For best results, point the flash heads directly at the subject and use FE lock (→ p.30) and modeling flash (→ p.29, 55).

When the correct flash exposure is obtained, the flash exposure confirmation lamp lights (→ p.16).

### Custom Functions

The MT-24EX has nine Custom Functions from C.Fn-1 to C.Fn-9. C.Fn-1 to C.Fn-7 are the same as the MR-14EX's (→ p.65), and C.Fn-8 and C.Fn-9 are described below.

#### Custom Function Settings

Function	Custom Function No.	Setting No	Description
Flash ratio control increments	C.Fn-8	0	1/2-stop
		1	Full-stop
Focusing lamp on/off by double-clicking the shutter button halfway	C.Fn-9	0	Disabled
		1	Enabled

C.Fn-9: Setting this to "1" enables you to turn on/off the focusing lamp by double-clicking the shutter button halfway. This is convenient when both of your hands are busy. The clicking interval differs slightly depending on the EOS camera. (The clicking interval cannot be adjusted.)

- C.Fn-9-1 does not work with the EOS D30.
- With the EOS Elan II/Elan II E/50/50 E, C.Fn-9-1 will work only while the pilot lamp is on.
- Turning the focusing lamp on and off too often will drain the batteries faster.
- If C.Fn-9-1 has been set, note that pressing the shutter button halfway too often during autofocus may inadvertently turn on/off the focusing lamp instead. This also applies to the AE lock button and depth-of-field preview button. Pressing any of these buttons twice in rapid succession or one button after another may turn the focusing lamp on or off.

# Major Specifications

The following specifications are specific to the MT-24EX only. Other specifications are the same as the MR-14EX's

Type .....	Closeup photography-dedicated, twin-flash unit with built-in wireless transmission/reception and E-TTL/TTL autoflash control
Configuration .....	Flash head assembly, mount ring, control unit, connecting cords
Flash coverage .....	Approx. 70 deg. vertical, 53 deg. horizontal (Reference position for one flash head)
Flash head movements .....	Relative to reference position Tilt: 45 deg. upward (22.5 deg. increments)/ 45 deg. downward (22.5 deg. increments) Swing: 60 deg. inward (15 deg. increments)/ 30 deg. outward (15 deg. increments) Mount ring rotation: 50 deg. upward (5 deg. increments)/ 30 deg. downward (5 deg. increments)
Maximum Guide No. (→ p.85) .....	Both flash heads: 24 Single flash head: 26 (at ISO 100 in meters)
Flash ratio control .....	1:8 - 1:1 - 8:1 - 1/2-stop increments (full-stop increments with C.Fn-8-1), (Flash heads A:B) 13 steps
Flash distance range .....	(1) In normal mode Both flash heads: Approx. 20 mm - 8.6 m/0.8 in - 28.2 ft Single head: Approx. 20 mm - 9.3 m/0.8 in - 30.5 ft (2) In high-speed sync (FP flash) at 1/320 sec. mode Both flash heads: Approx. 20 mm - 3.8 m/0.8 in - 12.5 ft Single head: Approx. 20 mm - 4.1 m/0.8 in - 13.5 ft
Focusing lamp .....	Duration: Approx. 20 sec. With C.Fn-9-1, the focusing lamp can be turned on/off by double-clicking the shutter button halfway.
Wireless transmission range .....	Indoors: Approx. 20 cm - 8m/0.65 ft - 26.2 ft Outdoors: Approx. 20 cm - 5 m/0.65 ft - 16.4 ft (while pointed at slave front and center)
Custom Functions (→ p.64.83) .....	Nine provided (C.Fn-1 to C.Fn-9)
Filter size .....	58mm dia. filter attachable to mount ring
Hood .....	EF 100mm f/2.8 MACRO USM lens-dedicated Hood ET-67 attachable to mount ring's hood mount(w/available light only)
Dimensions .....	Control unit: 74.0 (W) x 125.9 (H) x 97.4 (D) mm 2.9 (W) x 4.9 (H) x 3.8 (D) in Flash heads + mount ring: 235.0 (W) x 90.4 (H) x 49.0 (D) mm 9.2 (W) x 3.5 (H) x 1.9 (D) in Connecting cord: Approx. 30 cm/11.7 in, 6.6 mm/0.26 in dia.
Weight .....	??? g/??? oz(Including control unit, flash heads, mount ring, and connecting cords. Excludes batteries.)

- All specifications are based on Canon's measuring and testing standards.
- Specifications and external appearance are subject to change without notice.

# Major Specifications

## Guide No.

### [Normal Flash]

(At ISO 100 in meters/feet)

Flash Output	1/1	1/2	1/4	1/8	1/16	1/32	1/64
Guide No. w/twin heads	24/78.7	17/55.8	12/39.4	8.5/27.9	6.0/19.7	4.2/13.8	3.0/9.8
Guide No. w/single head	26/85.3	18.4/60.4	13/42.6	9.2/30.2	6.5/21.3	4.6/15.1	3.3/10.8

### [High-Speed Sync (FP Flash)]

(At ISO 100 in meters/feet)

Shutter Speed (sec.)	1/125	1/160	1/200	1/250	1/320	1/400	1/500	1/640
Guide No. w/twin heads	15.9/52.2	14.9/48.9	13.3/43.6	11.9/39.0	10.6/34.8	9.4/30.8	8.4/27.6	7.5/24.6
Guide No. w/single head	17.2/56.4	16.2/53.2	14.4/47.2	12.9/42.3	11.5/37.7	10.2/33.5	9.1/29.9	8.1/26.6

Shutter Speed (sec.)	1/800	1/1000	1/1250	1/1600	1/2000	1/2500	1/3200	1/4000
Guide No. w/twin heads	6.7/30.0	5.9/19.4	5.3/17.4	4.7/15.4	4.2/13.8	3.7/12.1	3.3/10.8	3.0/9.8
Guide No. w/single head	7.2/23.6	6.4/21.0	5.7/18.7	5.1/16.7	4.5/14.8	4.1/13.5	3.6/11.8	3.2/10.5

Shutter Speed (sec.)	1/5000	1/6400	1/8000
Guide No. w/twin heads	2.6/8.5	2.4/7.9	2.1/6.9
Guide No. w/single head	2.9/9.5	2.6/8.5	2.3/7.5

\* The above values apply to manual, full-output flash (1/1).

## Memo

This device complies with Part 15 of the FCC Rules. Operation is subject to the following two conditions: (1) This device may not cause harmful interference, and (2) this device must accept any interference received, including interference that may cause undesired operation.

Do not make any changes or modifications to the equipment unless otherwise specified in the instructions. If such changes or modifications should be made, you could be required to stop operation of the equipment.

This equipment has been tested and found to comply with the limits for a class B digital device, pursuant to part 15 of the FCC Rules. These equipment are designed to provide reasonable protection against harmful interference in a residential installation. This equipment generates, uses and can radiate radio frequency energy and, if not installed and used in accordance with the instructions, may cause harmful interference to radio communications.

However, there is no guarantee that interference will not occur in a particular installation. If this equipment does cause harmful interference to radio or television reception, which can be determined by turning the equipment off and on, the user is encouraged to try to correct the interference by one or more of the following measures:

- Reorient or relocate the receiving antenna.
- Increase the separation between the equipment and receiver.
- Consult the dealer or an experienced radio/TV technician for help.

Complies with the Canadian ICES-003 class B specifications.

Respecte les exigences de la class B de la NMB-003 du Canada.



The CE Mark is a Directive conformity mark of the European Community (EC)

The apparatus shall not be exposed to dripping or splashing.  
Batteries shall not be exposed to excessive heat such as sunshine, fire or the like.  
Dry batteries shall not be subjected to charging.

# Canon

**CANON INC.** 30-2, Shimomarucho 3-chome, Ohta-ku, Tokyo 146-8501, Japan

**U.S.A.** ————— **CANON U.S.A., INC.**

For all inquiries concerning this camera, call toll free in the U.S. 1-800-828-4040  
or write to: Customer Relations, Canon U.S.A., Inc.  
One Canon Plaza, Lake Success, N.Y. 11042-1198

**CANADA** ————— **CANON CANADA INC. HEADQUARTERS**

6390 Dixie Road, Mississauga, Ontario L5T 1P7, Canada

**CANON CANADA INC. MONTREAL BRANCH**

5990, Côte-de-Liesse, Montréal Québec H4T 1V7, Canada

**CANON CANADA INC. CALGARY OFFICE**

2828, 16th Street, N.E. Calgary, Alberta T2E 7K7, Canada

For all inquiries concerning this camera, call toll free in Canada 1-800-828-4040

**EUROPE, AFRICA  
& MIDDLE EAST** ————— **CANON EUROPA N.V.**

Bovenkerkerweg 59-61, P.O. Box 2262, 1180 EG Amstelveen, The Netherlands

**CANON COMMUNICATION & IMAGE FRANCE S.A. Service Center**

102, Avenue du Général de Gaulle 92257 La Garenne-Colombes Cedex, France

**CANON UK LTD.**

Woodhatch Reigate Surrey RH2 8BF United Kingdom

**CANON EURO-PHOTO G.m.b.H.**

Siemensring 90-92, D-47877 Willich, Germany

**CANON ITALIA S.p.A.**

Palazzo L, Strada 6, 20089 Rozzano, Milanofiori, Milano, Italy

**CANON Benelux N.V./S.A.**

Bessenveldstraat 7, 1831 Diegem (Machelen), Belgium

**CANON Schweiz AG**

Geschäftsbereich Wiederverkauf, Industriestrasse 12, CH-8305 Dietlikon, Switzerland

**CANON G.m.b.H.**

Oberlaaerstrasse 233, 4th floor, 1100 Wien, Austria

**CANON España, S.A.**

C/Joaquin Costa, 41, 28002 Madrid, Spain

**SEQUE Soc. Nac. de Equip., Lda.,**

Praça da Alegria, 58, 2º, 1250 Lisboa, Portugal

**CENTRAL &  
SOUTH AMERICA** —————

**CANON LATIN AMERICA, INC. DEPTO DE VENTAS**

6505 Blue Lagoon Drive, Suite 325, Miami, FL33126 U.S.A.

**CANON LATIN AMERICA, INC. CENTRO DE SERVICIO Y REPARACION**

Apartado 2019, Zona Libre de Colón, República de Panamá

**ASIA** ————— **CANON HONGKONG CO., LTD.**

9/F, The Hong Kong Club Building, 3A Chater Road, Central, Hong Kong

**OCEANIA** ————— **CANON AUSTRALIA PTY. LTD.**

1 Thomas Holt Drive, North Ryde, N.S.W. 2113, Australia

**CANON NEW ZEALAND LTD.**

Fred Thomas Drive, P.O. Box 33-336, Takapuna, Auckland, New Zealand

**JAPAN** ————— **CANON SALES CO., INC.**

12-15, Mita, 3-Chome, Minato-ku, Tokyo 108-8011, Japan

This Instruction Booklet is current as of August 2001. For information on using this product with cameras introduced after this date, contact your nearest Canon Service Center.